

# Panacea-BOCAF On-Line University

The educational series covering clean energy technology towards building our children a future. [Panacea-BOCAF](#) is a registered non-profit organization, dedicated to **educational study and research**. All copyrights belong to their owners and are acknowledged. All material presented on this web site is either news reporting or information presented for **non-profit study and research**, or has previously been publicly disclosed or has implicitly or explicitly been put into the public domain. **Fair Use applies.** [Contact us.](#)

Overview.....

Description.....

Replication.....

Faculty information.....

Supplies.....

Technical support forum.....

Links.....

Credits.....

## Overview

NOTE ON SAFETY WHEN TESTING- *It is very possible that the resistor itself is being pushed into microwave frequencies internally by the aperiodic operation. Microwaves operate as low as 300 MHz and some of Glen's scope shots show over 900MHz on the screen. Any Test or institution would face a serious liability if it promoted the use of something harmful. I strongly suggest having a microwave leak detector nearby during testing.* - Harvey

*This material clearly shows how to build an electric heating device that produces 17 times more heat than the "equivalent" amount of electricity. It accomplishes this by using a resistive heating element that also has inductive properties, and by "recycling" the energy of the inductive collapse.* - [Dr Peter Lindemann](#)

*My vote here carries with it the profound endorsement of Panacea's mission statement and a deep gratitude to all its current, foundational and past members. They have forged a vision in these chapters that represents a raft that will carry mankind's future to safe harbor. It is hoped that we all be colored by the deep convictions imbued in these principles that they may, thereby gain greater depth and clarity. This, in turn will inspire*

*others through such excellent and exemplary objects. Such a well spring of excellence in principle may then become the axial basis of our strivings that the health of our planet be secured. And therein and in truth, is our only hope.* - Rosemary Ainslie.

To deem that something doesn't work you have to disprove it. This work has been brought to Panacea's attention as a direct result of the individual efforts of open source engineers Peter Lindemann, Rosie, Jibguy, Joit, Luc, Jetijs, skywatcher, Dr Stiffler, **Glen (Fuzzy Tom Cat)**, **Harvey, Aaron** and others from the [energetic forum](#). [Rosemary Ainslie \(YouTube - aetherevarising's Channel\)](#) originally filled for a patent but unfortunately it was rejected.

The following additional publications have been previously filled:

Electro Information Technology (EIT) Conference IEEE Africon 2009 Paper

Patent Cooperation Treaty (PCT) Published Application WO 03\_007657 A2 (2003)

Quantum Article - October 2002

1999 European Patent Application EP0932248A1

Patent Cooperation Treaty (PCT) Published Application WO 99\_38247 (1999)

Please consult the faculty section for direct access to these documents. This technology has been reported by Rose to have been certified to produce a COP of 17 by BP and Fluke Instruments. The most authoritative accredited tester of this technology is ABB Research in North Carolina. The list also includes Sasol (SA) Spescom (SA) BP (SA) and others.

Rosie states: *I would welcome any requirement to defend my inclusion of their names in the paper in any court of law anywhere in the world. The prospect of doing so is very welcome. I have only one mission in life. **I want to prove that classical physics has already given us the tools to measure the energy that I, together with many others, point to as Zero Point Energy.** And if I am called on to defend this in Court I shall do so happily because it will give me an opportunity of also making public the facts of that claim.* - Rosemary Ainslie.

The open source FREE energy community have recently been working with Rose, Namely Harvey, Glen, Jib, Andrew Gardiner, Aaron and Ashtweth Palise to produce a replication of these results. So far Glen and Harvey have produced not only a practical replication resulting in a COP of 4, but also a technical thesis to help explain the effects. Rose is working towards her own *physics model* to explain the technology from her perspective.

Rosie welcomes all data collected but prefers replicators to show results with storage scopes and to sort out test parameters with batteries or something similar.

*It seems that we are getting in new experimenters and that's just really good news. I would be very pleased to hear of progress. I never intended to discourage this at all. But there is one point that I need to stress. **The waveform that is needed to generate this 'gain' on this circuit is fairly crucial. It's a relatively fast number and needs a generous bandwidth on the scope to show it. Then - because of the complexity - it also needs some reasonably reliable means of measuring it. This is most reliably done with data dumps directly from the storage facility of a good DSO.** Without this - then you will no doubt get familiarity with the means to expose this - but you may not be able to access the data analysis to prove that gain.*

*If you don't in fact have the required DSO's then I would recommend that you, at least, have a power supply source where you can establish the current required to generate the required temperature rise on the load resistor. And then run controls at that same current from a separate battery. If you run this concurrently, as we did, you will quickly see the difference in the performance of both the control battery and the experiment's battery. -R*

Luc has already shown some "entertaining" results on his related [YouTube - Effect of Re circulating BEMF to Coil test 8](#). This roughly equates to a 3.35 COP or 335%. Note – Please stick to the circuits listed in this document and not the one listed in the Quantum article.

Dr Peter Lindemann states" *The issue to focus on here is whether heat appears in the inductive heating element only when "electricity is dissipated" in it, or if heat also appears in the inductive heating element when "electricity is transferred" through it and recovered? This is the issue of interest. Obviously, if the second statement is true, and this is Rosemary's claim, **then it has extremely important ramifications concerning the entire field of "thermodynamics" and the supposed Laws that govern it.***

In the [Electric Motor Secrets](#) thread on the energetic forum Peter showed how to produce mechanical energy while recycling the electricity. With the [Imhotep](#) technology, it was pointed out how to light fluorescent lights while recycling the electricity. The Rosemary Ainslie's method is able to produce heat while recycling the electricity.

Skywatcher has observed the simple fact of what this circuit is showing us, just as Peter L. is showing us in his attraction videos. And that is that we can charge a coil, make a magnetic field and use the field in a non-impeding manner such as an attraction motor or other setup and then we can reuse most of the field when it collapses. This simple fact is what is most relevant.

This completes the "GENERAL CASE" of how to use electricity efficiently, first described by Nikola Tesla, and referred to by Gabriel Kron as "shuttle circuits". The real method to produce Heat, Light, and Motive Power, at efficiencies above the supposed limits described by the Laws of Thermodynamics, **which thanks to Rosie are now fully in the Public Domain**. Applications for the heating element could be a hot water heating element.

Rosie joined the energetic forum in the hope that all replication questions could be answered. **For those that have replicated the test, Rosemary wishes to state many, many thanks indeed**. And for those that are having problems duplicating results - hopefully we'll get to the root cause.

For new comers please keep in mind that Rosie resides in Africa, so for all American and other posters etc in the technical support forums, Rosie is probably hours out of synch and it may take a day before she can get back to you on any particular question(s). Rosie wishes to honor the "big show in town" being FREE energy or "[zero point energy](#)" to [Tesla](#), [John Bedini](#), [Peter Lindemann](#), Nunnerly, Aaron, SkyWalker, gotoluc and other contributors to the [energetic forum](#).

Rosie also wishes to state: *Thank you to everyone and it is wonderful to be part of such an extraordinary group of open minded people. You have no idea how rare you are - or maybe you do. For me it's an entirely new experience to see such ready acceptance of some really challenging concepts. I've been out there for some time now trying to promote these ideas and it's been bruising. Am pleased to report, however, that I think we're slowly winning acceptance.*

**A special thanks to Lisa we are all indebted for you generous donation of the brief us of the Tektronix equipment which has helped us show the world OU is possible.**

**Sponsorship is needed for replications, without the Tektronix equipment or something similar this research cannot be thoroughly tested and the open source results known.**

**Glen's requires a Tektronix's DPO 3054. A Tektronix DPO 3054 takes 5M ( million ) bits of data not 10K ( thousand ) like the TDS 3054C and to blow the doors of this project with new data from the "big" brother of the TDS 3054C if you can help please [Contact us](#).**

Rose initially helped contribute a great service to the open source community and collaborated to help author the paper "[Open Source Evaluation of Power Transients Generated to Improve Performance Coefficient of Resistive Heating Systems](#)" to the [IEEE](#). This is what the open source community is capable of when consolidated, with proper resources and the spot light in the educational community, we would change the world over night. Rose's move is the first open source device to be submitted to the mainstream this way with exclusively the open source community offering THEIR UNIQUE aptitude to this genre of engineering. **The IEEE sadly could not publish this system in**

**their renewable energy category and advised that Rose go down the physics paper route. What a predicament for humanity.**

Rose has stated: *The experiment was executed by the experimentalist Glen Lettenmaier so I am not due these compliments. We are hoping to publish the paper on this in a reviewed journal that academics can address the questions raised. If it is published then I don't think that there should be any further difficulties in raising funds for research and development. I would propose that you speak directly to Glen on the subject of applications and will forward this email to all the authors in the hopes that one or more of them can work with you on this. I am only theoretical and have no other contributions to make to this exercise, except, possibly, as it relates to that publication.*

*The initial experiments were published in Quantum Magazine - October edition, 2002 - and it lists five accreditors from public companies including Sasol, (SA) BP (SA) and ABB Research in North Carolina. But it was never advanced due to our inability to get this past the reviewers - or indeed past the credibility barriers of our academics. To a man they refused to attend a single demonstration or have anything to do with the claim. Extraordinary, when you think that they teach their students that science is advanced by experimental evidence. To get this onto the academic table is actually the final hurdle. Then I think this technology may be considered a respectable area for research and development.*

Further: *I am part of a team that belongs to the open source community and we have just written a paper on tests that result in anomalous heat signatures. The tests, in turn, were designed to test a non classical magnetic field model. We have been advised that the journals within TIE are the appropriate vehicle for submission, and after our own evaluation, assume that the most appropriate journal here would be in your Renewable Energy Systems Journal.*

*We, the authors, belong to an open source community and have a collaboration that spans most of the globe and three of its continents. The collaboration was enabled through the vehicle of the internet. <http://www.energeticforum.com>. If you go to this link it will take you to the last posts on that thread and the forum that hosted this collaboration. The paper that we have written relates to the replication of a test that was published in Quantum Magazine in October 2002 - and authored by myself and Brian Buckley.*

*This new paper details a series of tests that were conducted to prove that earlier claim and they have now been successfully concluded. Tektronix rallied to give us use of a TDS3054C DPO in order to extrapolate data. And the experimentalist, Glen Lettenmaier is currently doing a series of live broadcasts on the experiment to show those results and its distinctive waveforms in real time. But - while the data has been carefully collected and analyzed the results remain contentious. **Our objects in writing this paper is another***

**attempt by all of us to bring these tests to the attention of mainstream academia.** This is because the results fly in the face of thermodynamic laws and as such, we believe they constitute a discovery.

But this will never be established unless our academics can evaluate the experiment for themselves. And this will not happen unless the experiment is first published. We therefore are depending on the assistance and close co-operation of the reviewers and ourselves to revise the paper if and as required. It may be that the presentation is too long as we have almost doubled the recommended length and we are not sure if the reference to sundry links is permitted in the main body of that paper.

But quite apart from the niceties of its presentation we also would like to put on record, with the journal's editor, that the questions that are raised in this paper require close analysis by experts. For this reason, and because results effectively breach Thermodynamic Laws, we, and our supporting public, would prefer this to be published to extend that investigation to its broadest possible range. To the best of our knowledge there are no patent restrictions on the application of this system.

In effect we are looking to indulgences with regard to the submission. And, as mentioned, we would be very glad of advice in the way the paper needs to be presented. We have also taken note of the need for citations and would point out that it is difficult to find appropriate prior papers as there are none that refer to such an evident breach of the unity barrier. -Kindest regards, Rosemary Ainslie

Additionally: The experiment that Fuzzy(Glen) has completed shows that it's theoretically possible to run the average household heating requirements at anything up to and less than 75% of the current that you normally use. This also means that you can reduce your electricity bill by this amount. And also, it means that theoretically, we could reduce global carbon pollution that results from the way we're using electricity, by at least that amount. In fact, with fine tuning, we are not sure of the upper levels of efficiency that can be reached. But the numbers seem to get better with each test.

The problem is that we needed to prove this which meant that Fuzzy's measurements had to be accurate. Tektronix rallied and we were privileged to use their TDS3054C DPO which, as Fuzzy describes it, - is to measuring - what a Ferrari is to driving. Brilliant and perfect. But all oscilloscopes have a limit in the voltages they can measure. This meant that tests had to be kept to 'smallish values'. So. Nothing was tested at really high values. But enough was evidenced to show 'proof of concept'.

In other words, plenty research still needs to be done. This especially relates to the kind of heating elements which are needed - and the way to make those elements 'resonate' - which is tricky. But notwithstanding this, the facts are that there is early and unequivocal evidence that we can use electricity very much more economically than

*we are doing at present. Which is good news, as mentioned, both for the pocket and for the planet.*

*The down side is that these results are not really 'allowed' in terms of classical and quantum physics. It's to do with the laws that state - you can only get out what you put in. Something like that. They're known as Thermodynamic Laws and they've been in force and effect since the days of Newton. So. Our academics are justifiably sceptical. In fact they have entirely disassociated themselves from these tests and these claims for upwards of 10 years. We have repeatedly tried to bring them demonstrations and submitted papers that were rejected outright. But we're hoping that this 'open source' application may carry more justification for review as it's sort of 'public'.*

*The other thing of interest is that academics may need to revisit those thermodynamic laws. There are plenty of competing theories that account for this 'effect'. But I'm reasonably sure that our learned and revered will come up with an explanation that somehow reconciles these anomalies.- Rose*

**If you can help with this issue please [Contact us.](#)**

**PLEASE HELP AND FORWARD THIS PAPER TO YOUR FACULTY OR INSTITUTION AND LET US KNOW**

[Open Source Evaluation of Power Transients Generated to Improve Performance Coefficient of Resistive Heating Systems"](#)

*Rosie's terms of use state: Ensure that the paper and the technology are circulated to the appropriate departments for study and or replication. This will be circulated more widely to a number of universities and institutions in due course. However if any organization becomes aware of this technology on a formal basis and any employees get involved in independent test evaluations- Note that the aim is only to secure this discovery as an open source development with attendant proprietorship rights to publish.*

*The Receiver is thus to ensure that this communication, together with the attachments are circulated to the appropriate departments and that a copy of this is given to the CEO. This communication will be deemed as having been formally submitted with date, it is preferred that some acknowledgement of receipt is returned upon submission. -End*

The mainstream faculties are not going to get it any other way. It's a great learning curve and is something that's going to be able to be used to get other institutions to give recognition to the hard work the open source community does. Special thanks to Harvey and Glen, Jib, Dony and Rose. Rose has had a very hard time getting this

device known, ([A Brief History of the Ainslie Circuit](#)) **in true open source spirit, it is now our duty to honor and help disseminate this technology and make the principle know.**

Patrick Kelly the author of the [www.free-energy-info.co.uk/](http://www.free-energy-info.co.uk/) web site has done a brilliant introductory and laymen's write up of the circuits, for the beginner we recommend you start with this document. A Special thank you is in order to Patrick for his unmatched work in this genre.

[Ainslie heater circuit by Patrick Kelly](#)

*Patrick Advises: If you have not already done so, I suggest that you test the strength of the radio-frequency emissions from your prototype and if they are present ten feet away from the load "resistor", then you should add a note to the effect that the device should only be used when screened, otherwise unlicensed radio transmissions will be made by experimenters, leaving them open to prosecution. If you don't have the test gear, then just tune a transistor radio to the frequency of the device and see how far away the radio has to be to lose the signal.*

Panacea is the consolidation of the open source FREE movement; "Jibguy" is one of our most respected and talented writers of our Genre and has helped to produce [OpEdNews - Article: The Strange Case of the Rosemary Ainslie Circuit](#) . A Brilliant replicator Glen (Fuzzy the Tom cat) has also included [Open Source Research and Development - live streaming video powered by Live stream](#) to help advance education.

Channel there is a latest video library of available "LIVE" 5 Hour nonstop recordings of various Oscilloscope wave forms, temperature readings and device shots of the modified Mosfet Heating Circuit available for your viewing pleasure.

**Tektronix TDS 3054C**

7 - Recordings or 33 Hours

**Tektronix 2445A**

1 - Recording of 5 Hours

**Tektronix DPO 3054**

1 - Recording of 5 Hours

**\*Highlights\*** on January 9, 2010, January 24, 2010 and January 31, 2010 with the preferred mode of operation shown

Please note when ever discussing this technology in ANY of the technical support forums - Whilst the common need for courtesy is usually not a contractual requisite, it's



given as a natural condition of human nature. **Naysayers will not be tolerated**. The energetic forum has already made 2 examples of this behavior in the thread.

This energetic forum thread was sadly at the start full of sceptical nonsense. Just so you know here are a few sceptical claims made by supposed experts: This list is referring to Aarons replication where "i" is stated.

TK's (Tinsel Koala) claim the Quantum article timer is wrong (FACT - it works)

TK's claim the Quantum article circuit won't oscillate (FACT - it does)

TK's claim the oscillation is a red herring (FACT - it isn't)

Poynt99 and Poynt's claim there is NO AC in this circuit at all (FACT - there is in the load inductive resistor)

All claims the diode can't help charge input battery (FACT - it does)

All claims the spikes will damage the mosfet and that the ringing should be stopped (FACT - this mosfet IRFPG50 is designed EXACTLY for this kind of application)

All claims that the spike would be too small to be significant (FACT - on a decent circuit the voltage is 4 times the input voltage, it charges batteries or caps - it is VERY significant)

All claims that when the mosfet is off, the battery cannot conduct and therefore won't receive a charge (FACT - the diode in the mosfet allows just this exact current conduction as it is designed to do this!)

All claims that the spike will disappear with improved circuit connections, etc... (FACT - it only makes the spike bigger). All claims that the inductive resistor will change resistance as it heats up will throw off all the numbers (FACT - these resistors are made to be VERY ACCURATE at these operating temperatures. That is the whole point. They can be within 5% across a WIDE range of temperatures but the most discrepancy will be when they are extremely cold (way below ambient - or way too hot - this demonstrates the sceptics knowledge of this kind of resistor is completely lacking)

Sceptics claim that a battery capacitance analyser is an accurate way to determine battery capacitance for load testing and this supposedly makes the actual draw down tests unnecessary. (FACT - they are good only for sorting through batteries to see which ones need replacing or not. They are in NO WAY AT ALL - an accurate way to see what a battery will deliver.)

When sceptics analysed my waveform of the shunt - it was determined all the ringing was above the 0 line in the positive including the bottom half of the ringing. (FACT - The middle of the positive and amplitude of the ringing after the negative spike is in fact the

zero line - and by not knowing this, they admit they don't understand how to read a waveform.)

The sceptics claimed that the ringing cancels out any charging effect the negative spike will give. (FACT - The negative spike reduces what the battery delivers in net - the ringing down itself cancels itself out as far as battery charging ability but provides extra heat to the coil.)

TK claimed the Quantum article schematic (posted above) will not cause the mosfet to oscillate or do anything useful for the circuit. (FACT - with the EXACT circuit from the article, I can get the mosfet to oscillate - and I have shown pics and videos)

**All of these "sceptical" points have been conclusively proven wrong.**

*We have been given the raw deal, and lied to. It is a shame. But it is up to us to rise above and realize our potential, and just as important, help others realize their full potential. Please consider what each of you brings to the table each and every time you post. Each of our thoughts and actions sets forth a tension which reverberates through our world, it is up to us whether it adds or subtracts from the advancement of others. No matter what you have to say, people should walk away impressed by your humility and kindness. - Rosemary Ainslie.*

There are some important facts concerning this circuit that Rosie wishes ALL replicators and engineers to be aware of. These will also be updated as we find them; the following is thanks to Harvey on the energetic forum. Thanks Harvey!

Originally Posted by Harvey: - Note where TK (TinselKoala) is mentioned - This is referring to a replicator of the circuit.

*Hello Rosemary and all, I rarely dig deeply into things that TK is involved with because a great majority of his efforts are directed towards explaining fringe science by classical means. When he invested so much effort into this it really piqued my curiosity, because normally he can zero in on the root of the matter rather quickly. His hand waving about lost scope triggers did not set well with me and I had to go and read the Quantum article and the Newspaper article and have a gander at the patent application as well. When I saw that schematic I knew I had seen it before; at least the HEXFET arrangement with the inductive load. I knew that TK was using his own flavor of MOSFET and that can have varied results. So...digging back into my International Rectifier Designers Manual (HDM-3 September 1993) for HEXFET's I had a concerted look at the IRFPG50.*

*One of the features of that particular item is that it is 'Repetitive Avalanche Rated'. It is specifically designed to handle the voltage spike generated during and inductive field*

*collapse to the tune of 800mJ for a single pulse and 19mJ for repetitive pulses (depending on junction temperature).*

*Looking at the battery as an inductive-capacitor and the load as an inductive-resistor we can see that the source impedance of the battery will have a reactance as will the load. When these two items are tuned a certain way, we can expect a resonance to occur. When this happens (according to the documentation at 143KHz), the current through the load is AC and the EMF is converted to heat while the current moves in both directions, multiple times, while the ringing subsides. This condition can be exacerbated by the Avalanche characteristics of the IRFPG50, where additional current may initially flow subsequent to the off state of the device, which enlarges the magnetic field just prior to collapse.*

*One can see that this works similarly to a water-hammer in plumbing where the flow of water is suddenly stopped and the energy cascades back to the source and resonates between the source and the shutoff device until it is fully dissipated. Replicators, including TK, need to focus on the 143KHz secondary oscillation and how it plays a part in the documented results.*

*The instantaneous voltage across the load resistor will be the current through that resistor times it's resistance  $E=I*R$ . The IRFPG50 has a  $R_{ds(on)}$  of 2.0 Ohms. The sense resistor is 0.25 Ohms So the combined resistive circuit (not withstanding reactance's) is 12.25 Ohms. Two series batteries for a total of 24V across 12.25 Ohms are 1.96 Amps. Therefore, you should see 19.59 Volts across the load. The instantaneous power during that condition would be 38.4 Watts.*

*When the magnetic field collapses both in the battery and in the inductor, the voltage present could spike to over 1000V (The Avalanche Voltage for the IRFPG50) and cause a large current to flow for a very small period of time, but sufficient to enlarge the magnetic fields on the rebound and setup a resonant ringing that produces instantaneous values in excess of those above. When this condition occurs with sufficient frequency such that the ambient cooling of the load is unable to dissipate the thermal energy in the time provided, the load will increase in temperature even though the time slice that produces the heating is very small. -End*

*Rosie wishes to state: I'm just taking the liberty of reposting this because it is really important. It should put it at the top of every page of this thread. **Please all replicators of this test - read this through, and yet again. Thank you Harvey.** Where were you while we were plugging through this. And I hope you'll be around to guide us from here on. Many thanks indeed. - End*

Reference - [IRFPG 50 Datasheet](#)

This sheet mentions what Harvey said about the Repetitive Avalanche Rating and a few specs on it.

<http://www.vishay.com/docs/91254/91254.pdf>

**Diagram to help visualize Harvey's explanation Thanks to Aaron:**

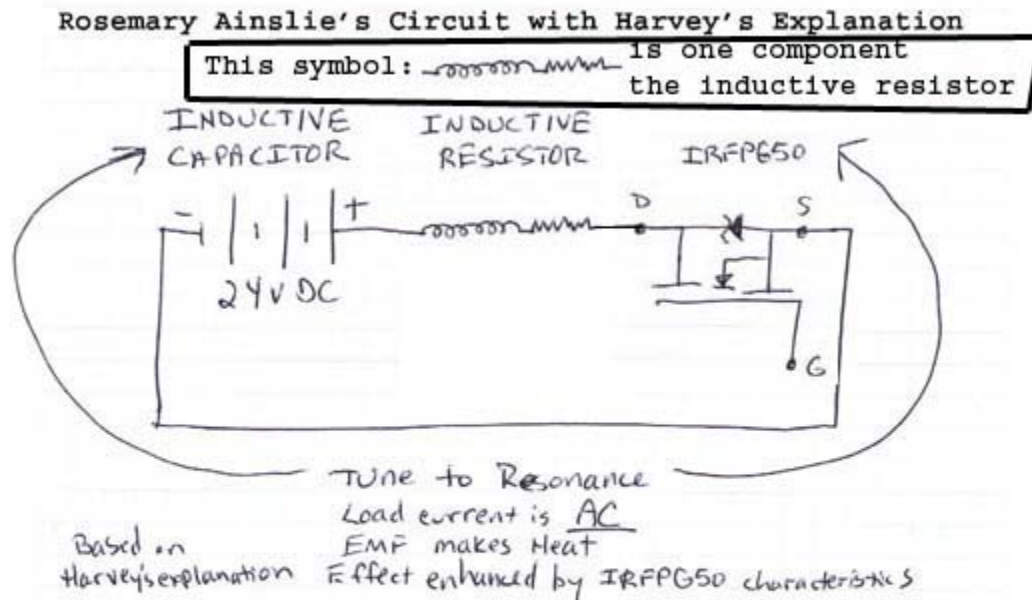

Discussion at [www.energeticforum.com](http://www.energeticforum.com)

**COPYRIGHT 2009 - AARON MURAKAMI - ALL RIGHTS RESERVED**  
**Distribute Freely Unchanged**

Aaron wants to point out that the inductor symbol next to the resistor symbol is ONE component...the Inductive Resistor.

Updated comments from Rosie and Aaron

I [Rosie] I have been advised that the best results are, indeed, without the use of that fly back diode. In other words, the Quantum article was right all along. To get the full benefit of the oscillation do the test without the fly back parallel to the load. The good news is that both configurations work and both deliver >1 COP. But the best results are simply - LEAVE THE DIODE OUT ALTOGETHER. I have no idea how I overlooked this advantage. Like Aaron has proposed. Do the test with both. The advantage of the diode is that it gives proof of battery recharge.

Relating to the Quantum Article by Aaron

Basically, all anyone has to do is simply do what the Quantum article describes to begin with. It is all there and has been correct from the beginning! Anyone that has experimented with the diode, consider it an incredible blessing because you could see the front battery really charges up while running and you can see how another battery, capacitor -Can be charged to store the inductive spikes to do work on the same circuit or elsewhere.

This is incredibly profound for the fact that while capturing all that recovered potential, heat was produced with less joules of energy than is normally required at the exact same time. Simply disconnect the diode and see the difference. -End

There is no rational to 'hold back' testing these circuits based on a psychological barrier. Rosemary wishes to point out that classical physics has already given us the tools to measure electric energy – The overriding object is to point out that electric energy is not constrained to unity any more than nuclear energy is constrained to unity. Nuclear energy - in the 3rd Law of thermodynamics - only requires a conservation of charge. **In the same way - electric energy also only requires the conservation of charge.**

*My hope is manifold. Because I also hope to hold your interest - while I plod through the logic that, at its least, **requires a redefinition of unity**. Then, when you guys see the logic, hopefully, like me your question will be - not how can one exceed unity - but how indeed, can one avoid it? It is that inevitable - and I may add, that's exciting.*

Rosemary's original test circuit is shown in the article that she originally tried to have published in a "refereed" scientific journal, but the submission was always rejected. In 2009, Peter Lindemann has had extensive email correspondence, and numerous telephone conversations with Rosemary, who lives in South Africa. After studying her work, many are absolutely thrilled with her discovery of the super-efficient heating effect. In mid-February of this year, an "idealized" schematic of her DC resonance circuit to produce the effects she had discovered was a proposed.

Technically - The Ainslie circuit is explained by Rosemary describes a solid-state switching device with inductance added to the windings of the load resistor, this is then run an oscillating frequency which results in a startling "efficiency" or what some call over unity device by a factor of 17.

These results were acquired in terms of a magnetic field model that has been developed, in terms of this model electric current is determined to comprise the transfer of discrete and discontinuous magnetic particle that can only move to or from that supply source , it proposes that energy that is dissipated actually emanates from magnetic fields within the structure of the load resistor itself, these fields were taped inside the cooling structure of the load resistor in the process of information and are

responsible for binding the atoms into atomic abodes. Under extreme conditions these fields can peel off as photons.

This results in the fatigue or degradation of the structure as can be seen over time, in effect the experiment was designed to prove that classical concepts of energy transfer as they assume a depletion of energy from the supply source as energy is transferred.

New discoveries in physics have been going on for decades, but do not have the faculty support or public protection from political and economic conditions, hence why Panacea has been able to uncover after 5 years of energy suppression research and have the goal of creating a NON PROFIT granted research and development center.

Despite Rosemary Ainslie's patented technology certified to produce a COP of 17 by BP and Fluke Instruments. The most authoritative accredited tester of this technology is ABB Research in North Carolina. The list also includes Sasol (SA) Spescom (SA) BP (SA) and others. When this research: Paper Title: "Counter Electromotive Force Enables Overunity Results in Electric Systems" was presented to the establishment here was the response:

*We regret to advise you that the Reviewing Committee is unable to accept the subject paper for publication as a PES Transactions paper even with possible revisions. Enclosed please find the comments of the reviewers that should serve to explain the recommendation of the reviewing committee. I hope you will find the explanations satisfactory. Although we could not accept this paper, we hope that you will consider Transactions on Power Delivery for other papers in the future. We thank you for your continued interest in the Power Engineering Society. Yours sincerely, Dr. Reza Iravani  
Editor in Chief Transactions on Power Delivery.*

And Just for the record. Rosemary has recently reported that they now got the distinction of a second rejection this time from an IEEE journal; it seems that mainstream will not consider this argument under any circumstances what so ever. This is suppression in an indirect sense.

Given the efficiency reports by this technology is an invaluable power management process which the mainstream faculties must benefit from. **As an emission cutting device and power savings device alone, this technology justifies (and needs) law for its mandatory implementation.**

The Nonprofit organization Panacea-BOCAF intends to support open source engineers working with the Rosie's and other suppressed /neglected and misunderstood clean energy technologies. These engineers require grants, resources, faculty recognition and security. All this can be created in [Panacea's proposed granted research and development center](#). For those able to help this effort, please [Contact us](#).

## Description

*We all owe Rosemary Ainslie a deep debt of gratitude, both for her discoveries, and for her willingness to publish her results for the betterment of Science and the human condition. -Peter*

Rosie describes the following in comparison to [Luc's Effect of Re circulating BEMF to Coil tests-](#)

The principle is this. On our experiment we generate counter electromotive force - not at a coil, as that would complicate the measurement protocol - but on an inductive load resistor. I believe they're referred to as 'curly wounds'. This still gives a kick - not as extreme as your coil - but enough for these purposes. This 'kick' is taken straight through the fly back to the positive terminal of the battery. We then see this. The battery is now able to recharge. And it is effectively being recharged from the very energy that it first discharged.

This, in itself is problematic. We are now saying, as Dr Stiffler pointed out, that we've withdrawn \$2.00 from the bank - spent \$2.00 and - from somewhere out of the ether - then re deposited something in excess of \$1.00 back to the bank. That dollar - or that something more than a dollar? Where did it come from? This is the problem that classicists wrestle with, with good reason.

So when we use a battery - in line with all good and classical measurements we can concede that the battery only delivers energy during the 'on' period of the switching cycle. We don't have to go into too much detail about the 'inductive component' as the inductive component here is in the resistor itself. Whatever it measures as 'heat' WILL also reflect the energy that was delivered. The question then is how to compute the energy that was first delivered. Well there's no coil. So, presumably if we use a 'shunt' on the negative rail on the supply - then we can measure the voltage on that supply. We know that what the battery delivers can only relate to the ON period of the switch as this is the only time that the battery can, in fact discharge any energy. So that part is relatively easy. We take the  $v_{batt}$  divided by the Ohm's value of the shunt to compute current - and then multiply the current by the battery voltage to compute wattage. This is correct and strictly conforms to good classical measurement protocol. Whatever that numbers it precisely represents the wattage delivered by the battery, then comes the tricky part, the duty cycle changes. The battery is, in effect, no longer able to deliver any current.

The fields on the resistor collapse to zero. And the strength of that collapse relates to the applied energy from the On cycle. Energy is energy. What comes in must go out. What gets kicked must be moved. And when magnetic fields collapse, all they are doing is

changing in time. Magnetic fields changing in time induce an electric field. But the strength of those changing magnetic fields from some voltage to zero - also needs to discharge. There is only a very short period during which it can discharge being moments between the 'on' and the 'off' time of the switch. It takes full advantage of that 'moment' and develops a spike to carry the full force of the energy applied in the On time and kicks it back in nano seconds as a 'spike' that is always evident 'between' the on and off period. That's the counter electromotive force.

But that energy is evidently also measurable on the shunt. And where does it go? It goes first through the battery, thereby recharging it - and then to the load thereby heating it up. So. We're back to that problem. How can we have found something more than \$1.00 when we've already spent \$2.00 to give anything back to the bank. And yet. The paradox. Our measurement of that delivery of energy is determined by classical measurements protocol. Not by me.

In effect, all we are trying to do is to generate back electromotive force. This can be done - obviously - in far better ways that is determined by the circuit. But the question out there has always been - how much energy is first required from the supply source to be stored and then used - anywhere at all, on any circuit? Well this is where the use of an inductive resistive load goes to the throat, the gullet, so to speak, of the question. You will notice that the actual voltage across the resistor always conforms to Ohms law. By this I mean to say that if you take the value of the applied voltage from the battery divided by the resistive load and times percentage of the duty cycle 'on' time - then that voltage never exceeds Mr Ohm's requirements and the wattage dissipated at the load is consistent with that sum. In other words, there is no EXTRA energy delivered by the battery during that 'on' period.

Then the switch closes and the battery can no longer deliver energy. Yet, during this 'off' period - and as required by Inductive Laws, the voltage over the resistor collapses first to zero and then through zero and then manifests as a reverse voltage spike that far exceeds the level of the applied voltage from the source. In point of fact, our measurements have always shown that if you do a  $v^2 / r$  analysis of this part of the cycle, the actual amount of energy generated during this 'off' cycle invariably equals the amount of energy first applied during the 'on' cycle but always less some small fraction which relates to the voltage drop across the diodes and sundry small losses in other circuit components.

In effect the cost of that 'spike' was zero - or it did not cost the battery any more energy. So we may conclude. While the 'on' cycle was courtesy the energy from the battery - the 'off' cycle was entirely thanks to and courtesy of the inductive components of the resistor itself. I think this fact was pointed out by Armagdn03? Not sure. I know I



read it somewhere in this thread. Well - whoever - that's spot on. And therein lays the question?

So the next question is what does one do with that spike? I'm sure that Peter and others who have studied this effect at far greater depth than me - can answer this better than I can. But my solution to prove its value was simply to maintain the circuit integrity during this 'off' period by the path established through the intrinsic diode in the MOSFET. And then ensure that the current resulting from these collapsing fields - gets returned to the battery. That - in a nutshell - is the whole of the thesis. And as I mentioned in the previous post to TinselKoala - the cost of current flow from the battery is then almost entirely compensated by the amount of energy returned to the battery through that diode.

In effect we're using classical measurement protocol related to the delivery of energy to prove that we can give this energy back - almost, but not entirely, intact. -End

Aaron describes that in this particular circuit, the heat amount appears to be absolutely disconnected from the current or voltage so measuring the heat and converting that to an equivalent amount of "electricity" is probably the only honest way to do it. The "rules" seem to be the same in most "over unity" systems. In [Bedini circuits](#), the output can't be truly measured but work in the battery on the output can be, etc. This is just an idea, don't know how it play out but perhaps the heat can heat x volume of water from x degrees to y degrees hot. It is known how much energy in joules must be expended to raise a certain volume of water from one temp to a certain temp. Then a thermometer can just be sitting in the water.

Peter describes this as a COP>20 device based on being able to "recycle" 95% of the electricity in the circuit. This is feasible when the inductance is constant, which it is in this case, and operating voltages are above 60 volts. Rosemary Ainslie's original circuit produced COP>17 in actual tests.

## **Replication**

*The Wave is right, because the Peak from the Pulse can be adjusted with the Pot at the Base from the Transistor, in what length it hits the Base, so a lot Transistors should work. I can adjust the Peak to a standing Triangle or a laying Triangle, The Peak, what hits the Base can get adjusted over the Pot at the Base, and therefore you get different Duty Cycles. And I bet, when I play further around with it, I even get the same results, as you did at your Tests at the Table from the Quantum Article.*

*I know, it works, because i had a different Thread about How to get extra Energy from a Coil, where the Point is, that you have to pulse the Coil at the right Moment, and get very much better Results from it.*

*But the Magnetic field, what is build up in the Coil does matter, when that Point of Time is. And well, i use a RGP02-18 Diode here for the Timer, fast switching Diodes too, but i don't think, that does matter.*

*My Circuit is easy and exactly adjustable from 0 - 11Khz right now. -Joit*

*Note - This is just a tip for anyone testing this circuit, if you're using clip leads for testing make sure the clip lead is good by using continuity check on meter, because my results disappeared because the wire had intermittent connection on the flyback diode, seems those pulses damage these cheap clip lead wires easily. or just make short connects, that would solve any wire issues. The extra heat is back again after replacing the bad wire.. - Skywatcher*

### **Revised Circuit Diagram by Glen (FuzzyTomCat)**

*Intro By Harvey -**Fuzzy has done the bulk of the work here and really deserves the credit for getting us this far. He has developed a skill for tuning this circuit into preferred oscillation and hopefully that can be passed on to others who wish to experiment with this arrangement.** It should be mentioned that his circuit runs much faster (between 2 to 8 times) in preferred oscillation than the original circuit from the quantum article. Also, his timer is set at a much faster setting than the published 2.4kHz, in fact with the load resistor disengaged he could not get below 70kHz. Look carefully at his published schematic in prior posts to ensure your replication efforts align with his. It would be difficult to pinpoint exactly why this difference exists, but I do know that manufacturers make various improvements or changes to transistors and IC's as the years pass.*

*The IRFPG50's we are using today, may not have the published capacitance in my 1993 designers manual. It is believed by me that the MOSFET capacitance plays an important role in the aperiodic resonance and subsequent subharmonic recursions that result in a shift of current phase at the load resistor. Normally the inductive portion of the resistor would experience a current lag that precludes full power from being dissipated and instead returns it in the form of apparent power. But in the case under test we find a negative current present in time with the full voltage recovered from the magnetic field to allow full power to be applied to the resistor as the current flows back into the battery.*

*The realization of excess heat and RF radiation indicates that a source of energy is present separate from the supply batteries. More research is needed to specifically ascertain the secondary source. Interestingly, this result was predicted by the Magnetic Model by Rosemary Ainslie which identifies the source as material decay which gives up its energy as atoms become disassociated from the resistor structure. When the energy which binds these atoms and molecules together is no longer performing that service, then it becomes free to be applied to do work and in this case it readily adds heat to the material.*

## Rosemary Ainslie Heater Circuit "Final"

**Testing Resistor Set** : Here is the set of prototype 10 Ohm "Borosilicate Glass Tube" ( Pyrex ) wire wound load resistors that has been made using AWG 20 [.032 dia] ( .6348 ohms ft ) "Ni Cr A" 80% nickel, 20% chromium resistance wire for testing and evaluation on the modified replication of the "Mosfet Heating Circuit" .

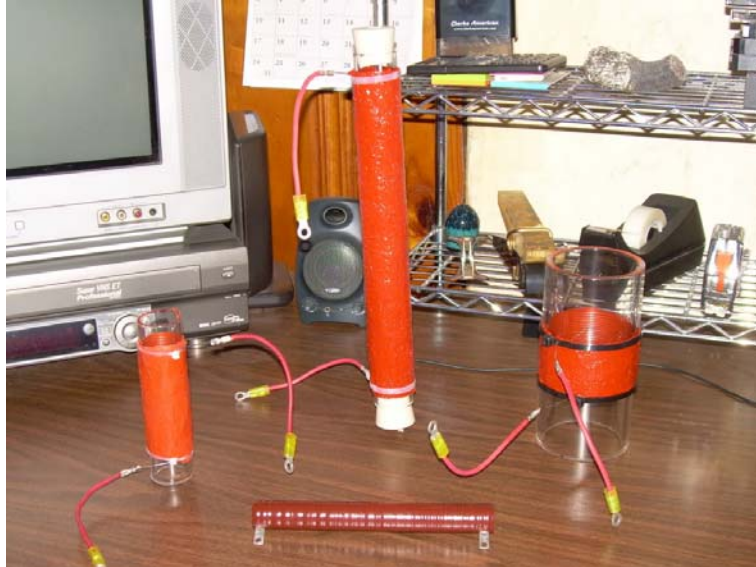

### Picture from Left to Right

1) 32 mm diameter , coil length 3.375 inches , wire spacing gap 1 mm , uH - 20.41 ( calculated )

[Complete Construction Details](#)

2) 32 mm diameter , coil length 10 inches , wire spacing gap 4.762 mm ( approx ) , uH - 8.64 ( calculated )

3) 76 mm diameter , coil length 1.750 inches , wire spacing gap 1 mm , uH - xxx ( calculated )

### Picture Center Front

4) 19 mm diameter , coil length 6.5 inches , uH - 18.81 ( calculated )  
100 watt , Memcor # FR100 / 7931 "Off The Shelf Store Bought"

Here is the finalized RA Heater Circuit Schematic and Component List for the best operation that I have achieved through my replications so far on this circuit. Note - [This](#)

[Open Source thread](#) is for the advancement of a "Mosfet Heating Circuit" one that is a **modified** replication of one described in the Quantum October 2002 article.

**Rosemary Ainslie COP>17 Heater Circuit**

REVISED 11-26-2009

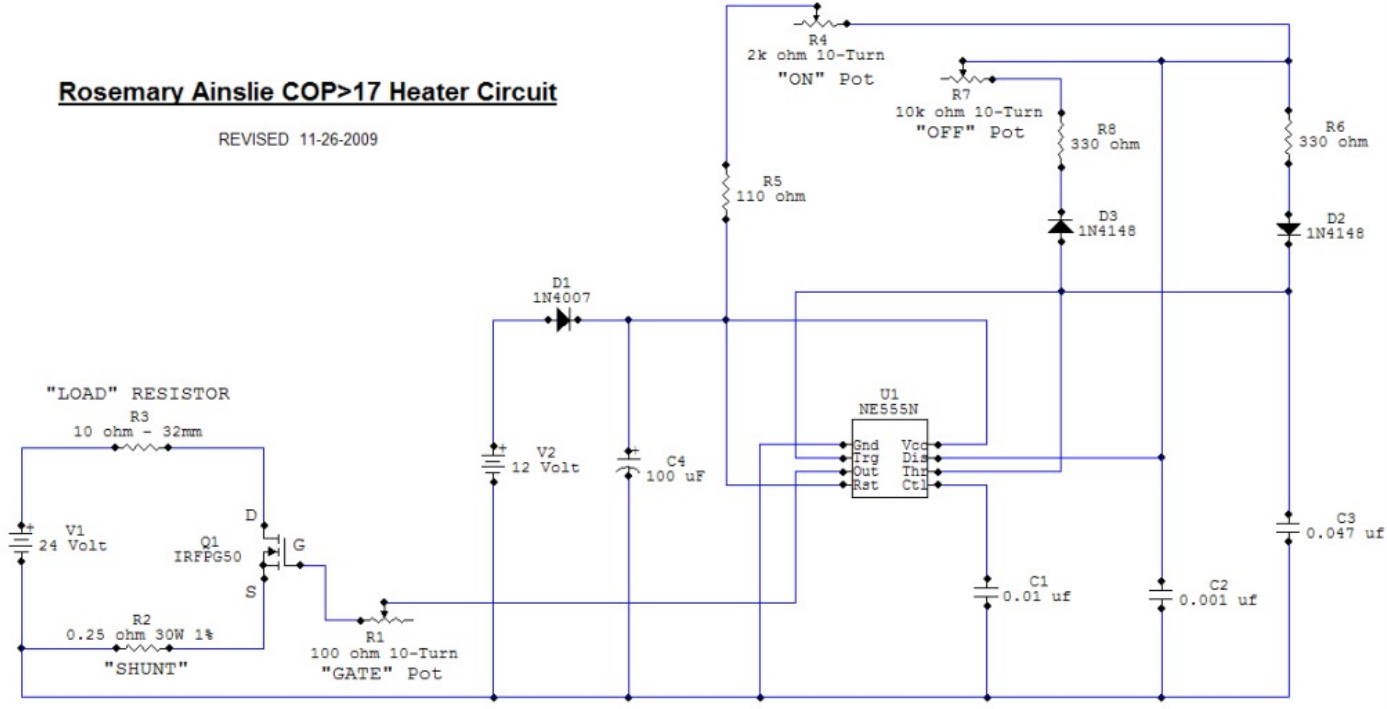

**CIRCUIT DIAGRAM**

## CIRCUIT COMPONENTS

C1	0.01 uF Capacitor
C2	0.001 uF Capacitor
C3	0.047uF Capacitor
C4	100 uF Capacitor
D1	1N4007 Diode
D2	1N4148 Diode (1N914)
D3	1N4148 Diode (1N914)
Q1	IRFPG50 HEXFET Mosfet, International Rectifier
R1	100 Ohm Potentiometer 10-Turn 2-watt, Vishay Spectrol #SP534
R2	0.25 Ohm 30 watt 1% non-Inductive Resistor, Caddock Electronics Inc. #MP930
R3	10 Ohm + - 5% Prototype wire wound "Quantum" Load Resistor
R4	2K Ohm Potentiometer 10-Turn 2-watt, Vishay Spectrol #SP534
R5	110 Ohm 1/8 watt Resistor
R6	330 Ohm 1/8 watt Resistor
R7	10K Ohm Potentiometer 10-Turn 2-watt, Vishay Spectrol #SP534
R8	330 Ohm 1/8 watt Resistor
U1	NE555N Timer, Fairchild Semiconductor
V1	12 Volt "Liquid" Lead Acid Battery (x2), Exide Technologies #GT-H 12aH (24aH)
V2	12Volt "Gel" Lead Acid Battery, CSB Battery Company #GP 1270 F2.7aH

CIRCUIT ADJUSTMENTS - ( For the most efficient results but with less heat ) Use a Digital Multi Meter (DMM) or bench top unit able to see 0.00 type ohms if possible, not just tenths but hundreds to get the pre-set "sweet spot" between 5.80 to 5.30 ohms (checking pot back lash) then using a DMM to monitor the highest voltage reading from your 24 volt battery bank while doing GATE pot "fine adjustments" of more or less resistance to reach that highest voltage reading needed for the most efficient results.

If you go by this and the adjustment procedure which I cannot say how important it is for anyone wanting to get results in any gains is by "fine" adjustments to the "gate" potentiometer in the 5 to 7 ohm range monitoring the 24 volt "liquid" lead acid battery bank voltage with a DMM to get the "HIGHEST" battery voltage possible, watching the gate potentiometer backlash and getting the "LOWEST" mV reading from 40 to 80 mV mean on the oscilloscope probe tip between the Mosfet source and the shunt resistor. I realize you don't have a scope at present but when you do please try to use [POST 3035](#) for an example and instructions on what you should see. The components listed in the revised circuit are almost the same values and items as the ["Quantum" October 2002](#) article.

***Note the "Negative Dominate Wave Form" Schematic version was not made to generate heat as per Aarons [POST 3019](#).***

*"Negative Dominate Wave" form generator circuit -*

[Post #2606 \(Tektronix 2445A Scope\)](#)

[Post #2764 \(Tektronix TDS 3054C Scope - Part 1\)](#)

[Post #2766 \(Tektronix TDS 3054C Scope - Part 2\)](#)

*Aaron's "Negative Dominate Wave" form generator schematic is totally different from the "Mosfet Heating" circuit and the #2606 posting was my attempt using Glen's Scope.*

*The other two postings #2764 and #2766 was on a Tektronix TDS 3054C that was available for my use at Aaron's residence for a time and he was able to fine tune my replication, being he was much more familiar with the circuit and the Scope being used he has much more time and effort in this circuit than anyone I know*

Any added resistance and the capacitor is unneeded and may have unwanted effects to the circuit, with those components they may impede supplying energy back to the battery making the circuit less efficient but with more heat. If everything is operating properly we should see the 24 volt battery bank voltage stabilize or actually increase in voltage which was indicated in the original RA COP>17 Heater Circuit outlined in the "Quantum" article, this I have seen several times during the circuit operation the last time was when I was getting ready for TEST #8 [POST 3108](#) when looking at the images at the Channel-4 green trace the Voltage "RMS" and "Mean" in the right column went up several times if you look at the date and time stamp when the circuit was under operation.. So I'm possibly really close to some impressive readings now. I'm sure you're on your way also to getting some good readings. the one thing I did notice is the RTV if really thick acts like a insulator keeping the heat inside I tried to keep mine as thin as possible which was really hard but being my core is 32mm borosilicate glass tube there is the option of mine to use the inside of the tube for measurements and heating fluids if needed or required.

If you're using some alligator clips test wire leads remember the voltage and amperage of the device under testing, ours has high voltage and some amps to the circuit. Some of the clips look like they are in the mV range and may be inadequate for the application you might check. I've seen about **700** volts on the Mosfet drain pin and **100** volts going back into the battery shown in the last scope shot ( **100ns** ) in POST #3108. So tight connections are a must in the 24 Volt side of the circuit.

The Mosfet that is used in the Rosemary Ainslie circuit is -  
IRFPG50 is rated @ 1000 Volts Vdd

<http://www.datasheetcatalog.org/data...rf/irfpg50.pdf>

The best and most inexpensive source is :

[Quest Components - Resistor & Capacitor Distributors - Obsolete Electronic Components - Discrete Semiconductor Distributors - Integrated Circuit Distributors](#)

[Quest Components IRFPG50 Part Number Search Results](#)

Here is a "Snap Shot" of the IRFPG50 Mosfet oscilloscope Channel-2 "drain" pin operating with a 76mm diameter 10 ohm load resistor and the voltages that were achieved over 800 Volts normal operation is over 500 Volts with a 32mm diameter 10 ohm load resistor.

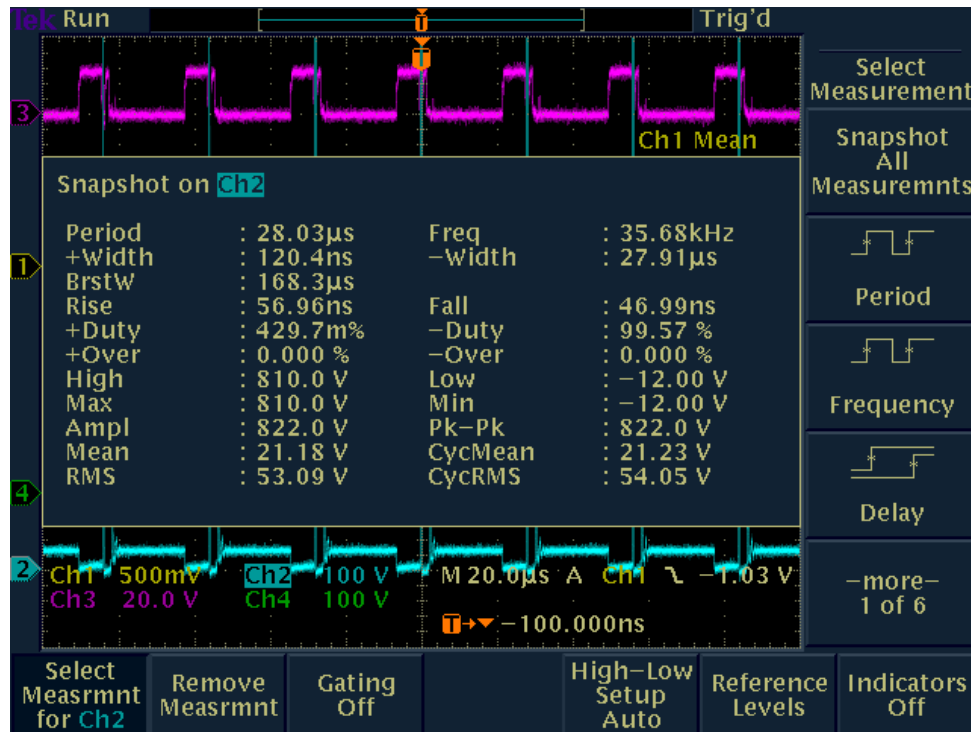

The length / gauge / diameter of the wires and layout of the circuit board may be the amount of series gate resistance required to get the correct oscillation. The type of series gate resistor is critical - use this one: <http://www.vishay.com/docs/57065/533534.pdf> (I would go for the model 534 type)

Difficulty may be experienced in using a contact probe thermometer. An IR non-contact / laser thermometer is ideal for measuring temperature. Check the oscilloscope for phasing / discrepancies by joining the input terminals together and then measuring the one square wave source. The waveforms shown on the screen should be identical or within 5 - 10ns of each other. (see attached image). If there are any discrepancies, try adjusting the calibration screw on the oscilloscope probes.

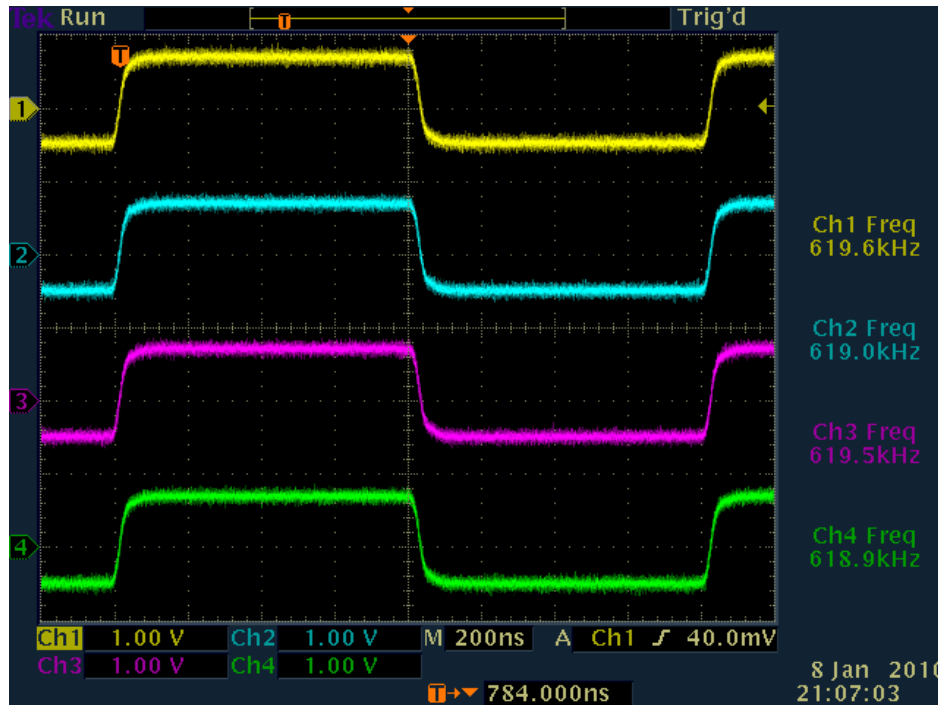

Note please visit Glen's live broad cast channel: "[Open Source Research and Development](#)" channel showing this threads circuit in operation in various stages of oscillation. The last show was the "Preferred Mode of Oscillation" that includes the sub harmonic modulation that we have deemed necessary for the COP> 1 results which we prefer and must be forced by careful adjustments.

The January 9, 2010 show was the best showing this "**Preferred Mode Of Oscillation**" in the first 2 hours of the 5 Hour long tape ( search-able video timer shown with time left )  
[Open Source Research and Development - January 9, 2010](#)

#### TIME

- 4:45** \_ 24.68 to 24.69 VDC Starting Voltage
- 4:01** \_ 24.72 VDC Highest Voltage Reading
- 4:00** \_ 24.71 VDC
- 3:33** \_ 24.70 VDC
- 3:17** \_ 24.69 VDC Return to Starting Voltage
- 2:54** \_ Temperature Readings
- 2:52** \_ 24.68 VDC

#### STARTING TEMPERATURES READINGS -

- 139 Degrees F - 10 ohm load resistor
- 161 Degrees F - Mosfet
- 113 Degrees F - .25 ohm shunt resistor



## **2:54 TEMPERATURE READINGS -**

138 Degrees F - 10 ohm load resistor

158 Degrees F - Mosfet

107 Degrees F - .25 ohm shunt resistor

**5.27 Watt Load** ( Load Resistor ) on circuit during operating throughout the time length indicated.

End

### **Glen's detailed Walk through**

I'm sorry it took so long to do a detailed overview of the "LIVE" broadcast I did in the "[Open Source Research and Development](#)" channel on the [January 9, 2010](#) 5 Hour nonstop video recording.

This video as you are aware is one of the best ever recorded representation of the preferred mode of operation but only in a nonstop 5 Hour video. I'm sure that many members and guests don't realize the difficulty in capturing this effect for the purpose of recording the data properly and if given the time looking at the recorded video everyone can see the problems that we face in getting accurate data.

The constant 24 volt battery bank voltage fluctuations going up and down the Mosfet "drain" spike oscillating from 500 to 900 volts, battery voltage down the Mosfet spikes, battery voltage up the Mosfet voltage to normal operating range, back and forth over and over.

I have tried to get as close to this mode of operation in [Test #13](#) which was used in the IEEE submittal [Open Source Evaluation of Power Transients Generated to Improve Performance Coefficient of Resistive Heating Systems](#) the team including yourself did, and in [Test #22](#) but never being able to record the data scientifically correct because of the circuits complex oscillating waveforms. I don't think everyone, members and guests understands that the Test #13 was done with a Tektronix TDS 3054C which has a maximum resolution of 10K of data spread over a 10 x 10 grid or divisions so each one has 1k of data samples separately for each of the 4 channels. The data collected in Test #22 was with a Tektronix DPO 3054 which has a maximum resolution of 5M of data, but I used the 100K which is spread over the same 10 x 10 grid or divisions so each one has 10k of data samples separately for each of the 4 channels ..... ten ( 10 ) times the data of the TDS 3054C used in Test #13.

The problem being we need to find a method of capturing the data continuously in real time, there's nothing wrong with Tektronix TDS 3054C or the DPO 3054 these are the

finest instruments I've ever used and are extremely accurate, but if you push the acquire button at the wrong time you can appear to get conflicting or skewed data, not the case .... were you before the spike, during the spike or after the spike when the data was collected. I had a allotted dedicated set time to record the data, It was the time frame I used with the 6 minutes or as fast as the data could be physically collected with the finest equipment I had at my disposal.

I am in total agreement with you that something "good" is happening in the Mosfet Heating Circuit and can be plainly seen in the recorded videos, we just need to somehow get a streaming real time data recording. Maybe by somehow obtaining a [Real-Time Spectrum Analyzers](#) from Tektronix or some other method to verify the data findings as you suggested, the equipment I previously used as good as it is, just isn't enough to totally capture what is occurring during the preferred mode of operation. - End

The following post is a recap of my "LIVE" recording at "[Open Source Research and Development](#)" which is the best recorded representation of the preferred mode of operation a [5-Hour non stop video recording on January 9, 2010](#) using a Tektronix TDS 3054C Oscilloscope.

This 5 hour video recording is from a dead start after the scope calibration as all testing and evaluation of the circuit. Please see Image time bars for actual recorded times in hours, minutes and seconds.

**Channel 1 - Mosfet Source Pin**

**Channel 2 - Mosfet Drain Pin**

**Channel 3 - 555 Timer Pin 3**

**Channel 4 - 24 Volt Battery Bank**

**Scope Trigger - Channel 1 "FALLING" signal slope [ \ ] *"IMPORTANT"***

**"START"**

First connecting the 12 Volt battery to 555 timer circuit only, adjust the "ON" potentiometer to minimum resistance (0), adjust the "OFF" potentiometer to maximum resistance (2K), resulting duty cycle is at about 21.48 %

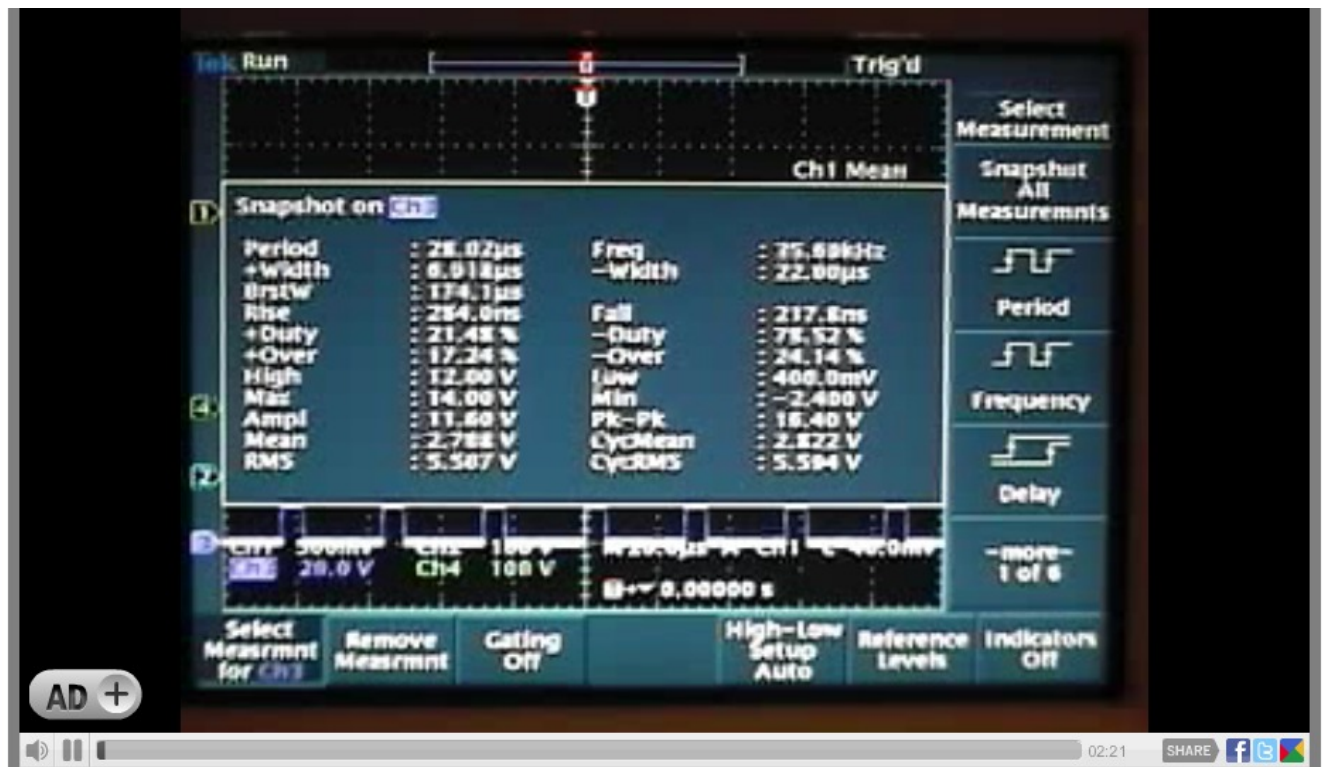
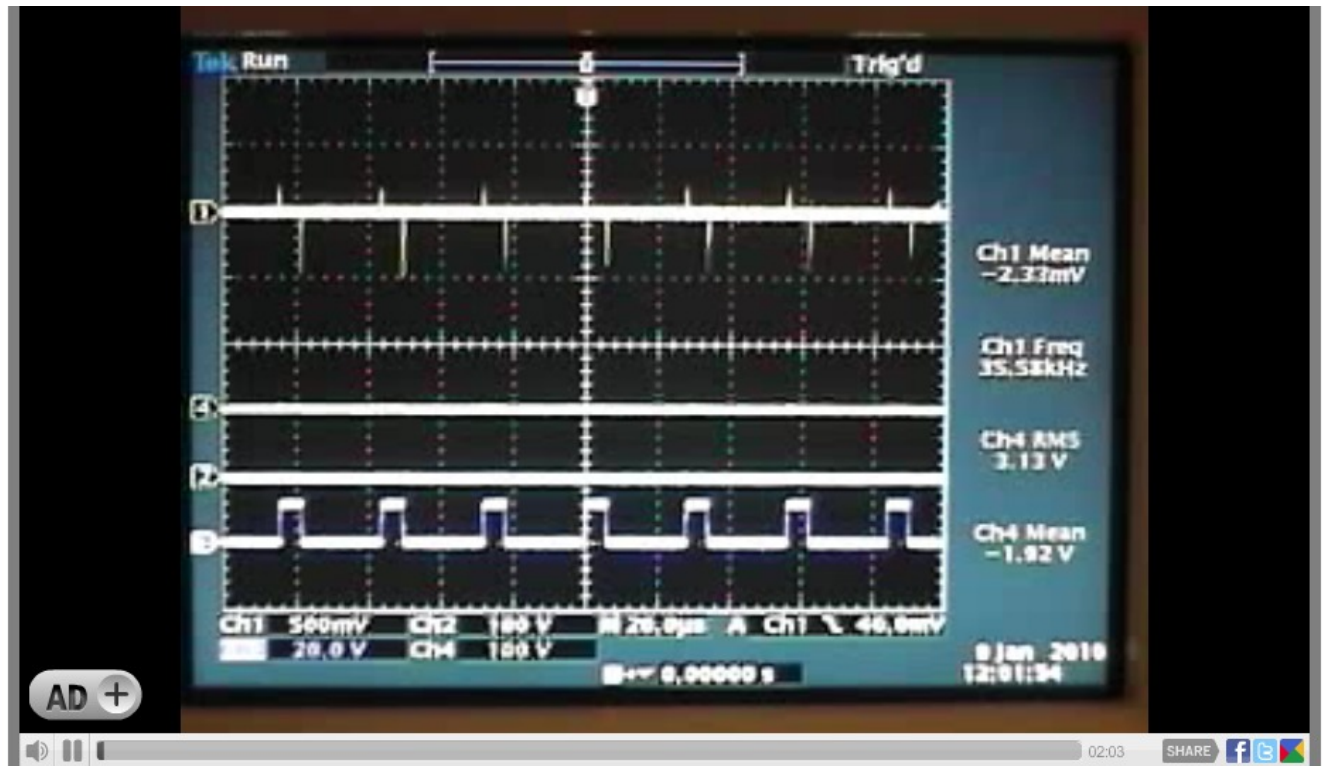

Now Connecting the 24 Volt battery bank to the device circuit not touching the "ON" or

"OFF" 555 timer Potentiometer again. The circuit now defaults to a 50 - 55 % duty cycle, no further "ON" or "OFF" potentiometer adjustments needed.

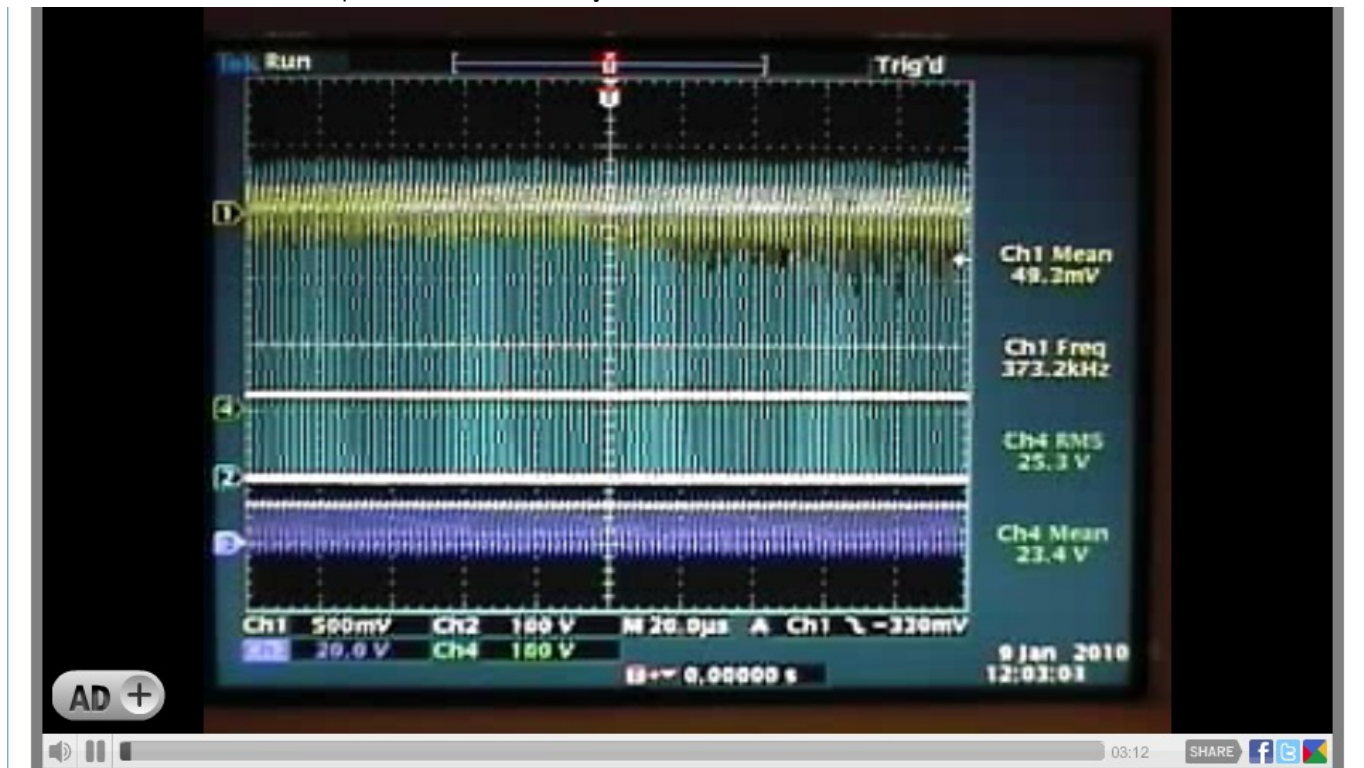

Now adjusting the "GATE" potentiometer "only" using the oscilloscopes 100ns division for minimum Mosfet source Channel -1 Mean mV from 50 to 70 and the four (4) divisions from the 555 timer "OFF" signal to the Mosfet drain or 24 Volt Battery signal "spike" combined with the Fluke 87 DMM highest voltage reading connected to the 24 volt battery bank

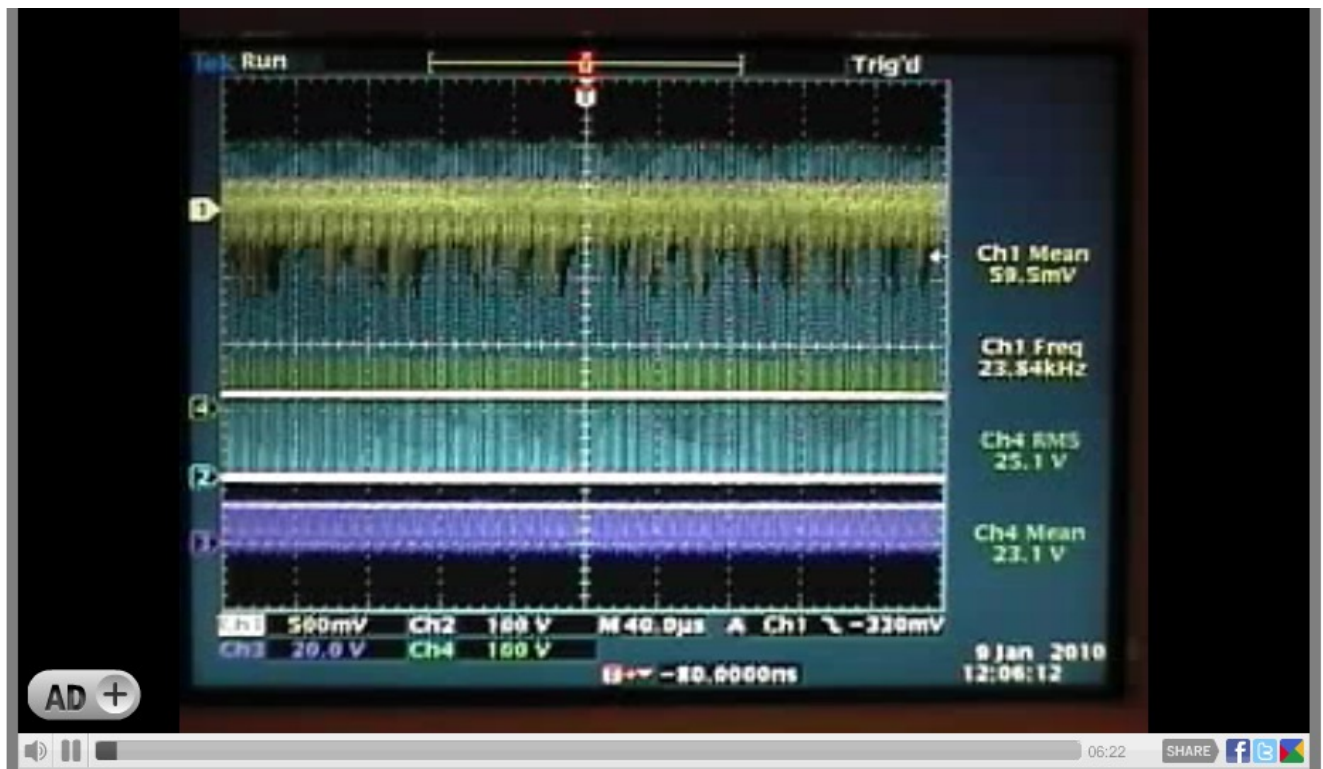
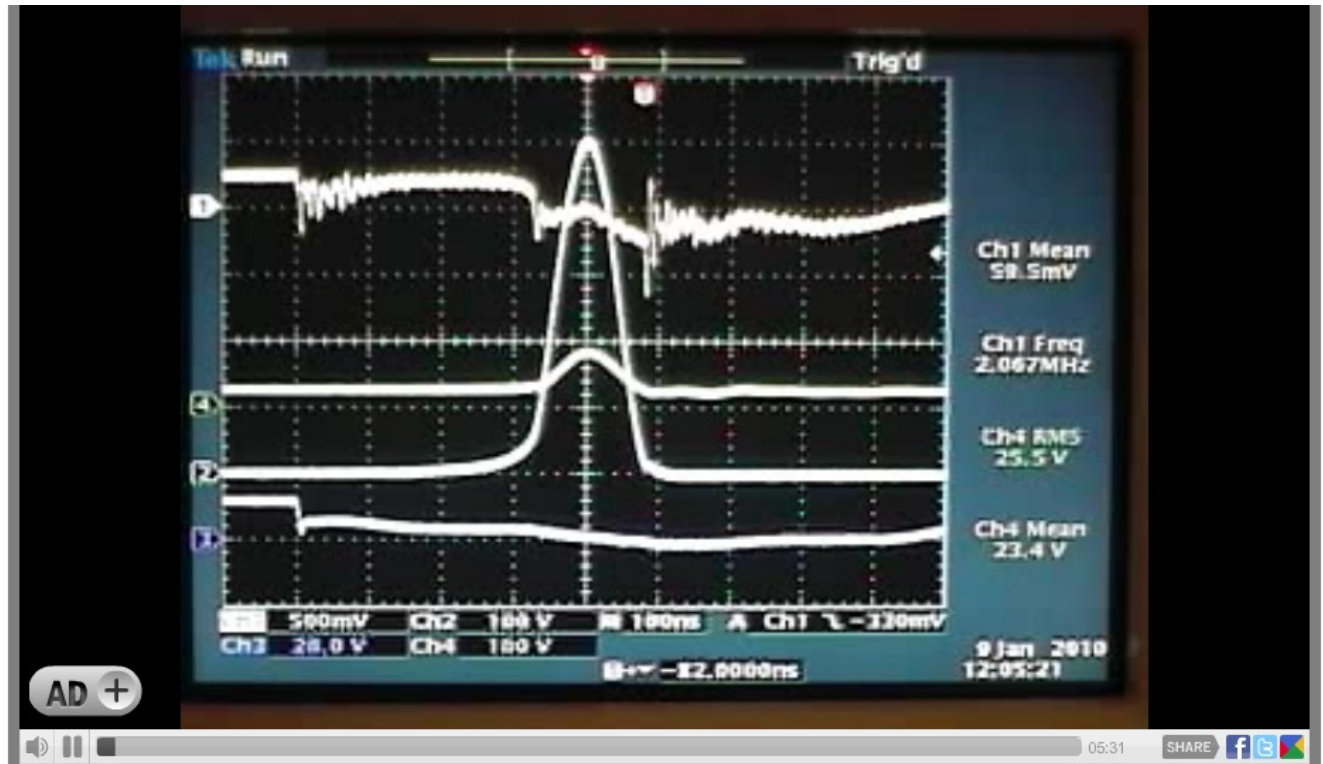

Now the double checking of the "GATE" potentiometer adjustment "only" using the oscilloscopes 100ns division for minimum Mosfet source Channel -1 Mean mV from 50 -

70 and the four (4) divisions from the 555 timer "OFF" signal to the Mosfet drain or 24 Volt Battery signal "spike" combined with the Fluke 87 DMM highest voltage reading connected to the 24 volt battery bank.

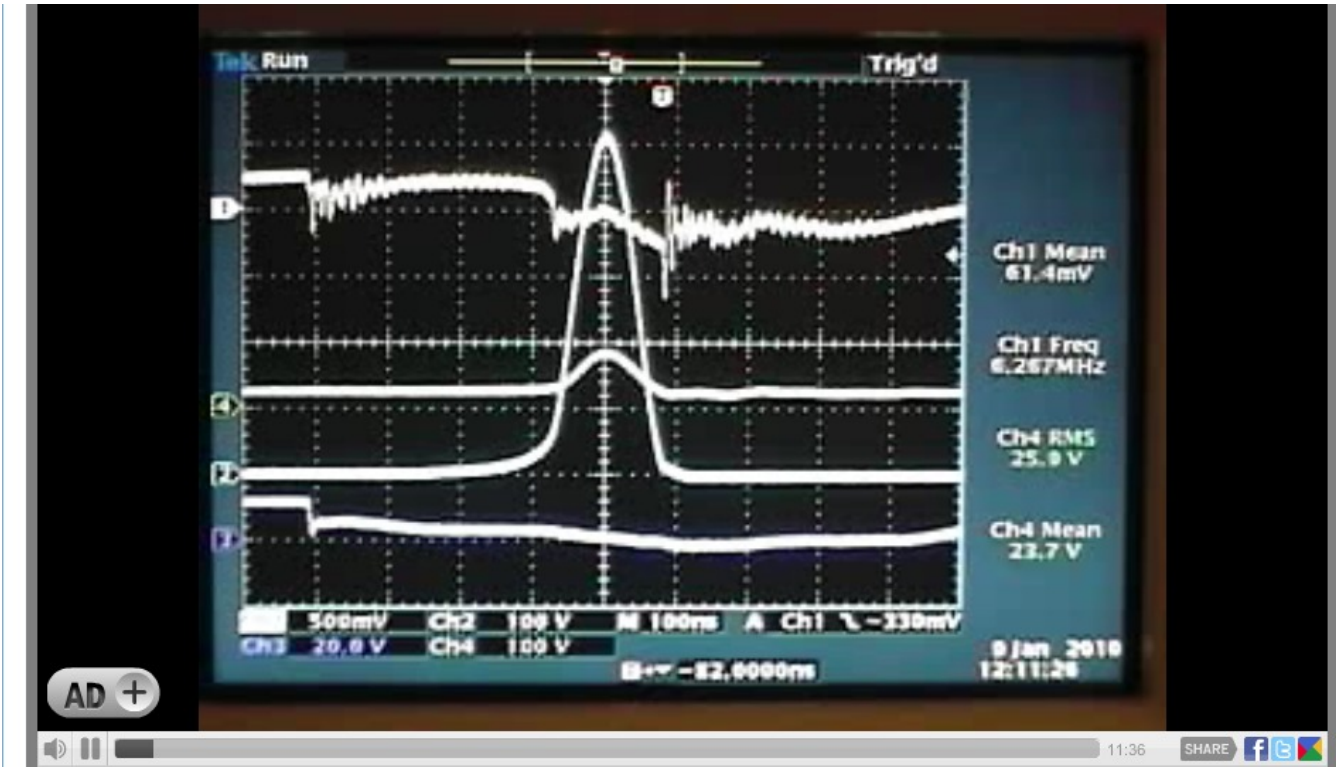

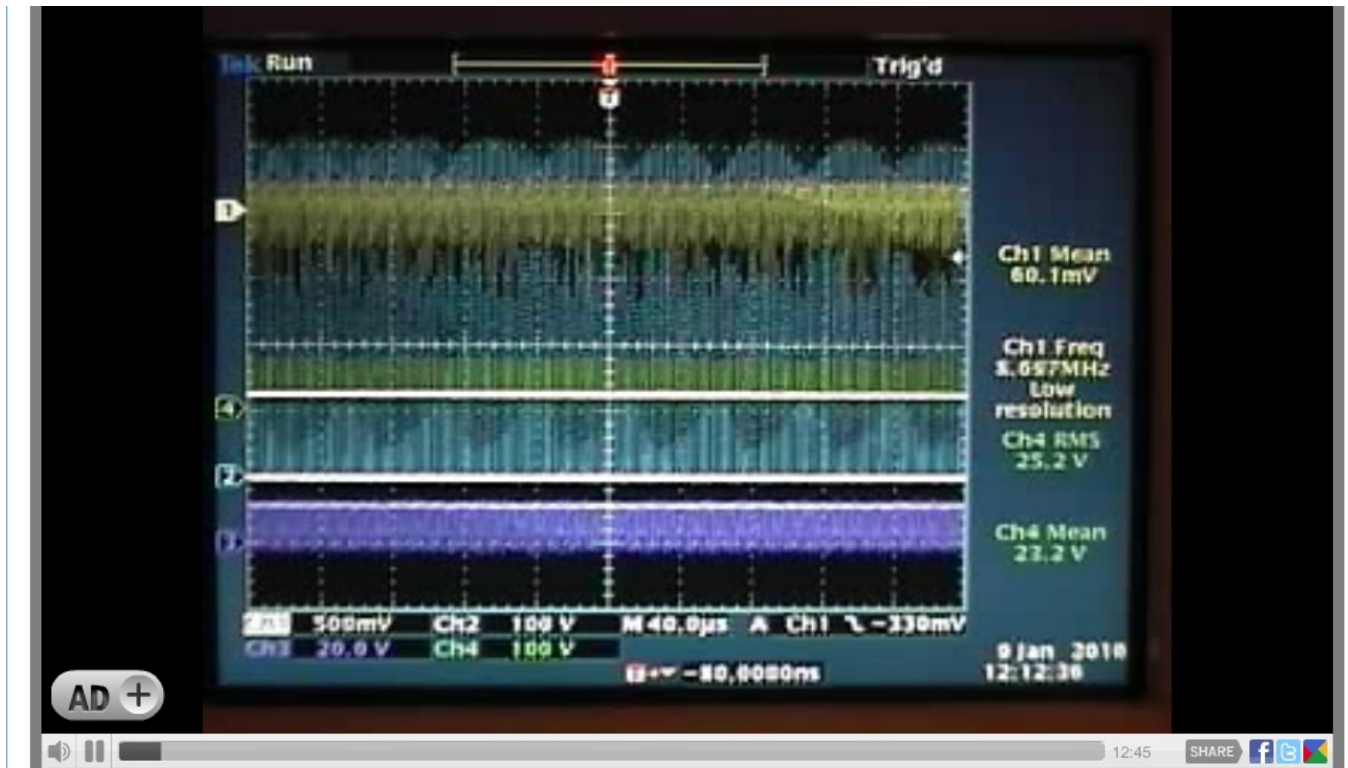

The Mosfet circuit is now 100 % fully functional in the preferred mode of operation and under "load" the 24 Volt Battery bank Voltage is now at 24.70 DC Volts with no further adjustment to be made on any of the circuit potentiometers.



A now recorded 24 Volt battery bank voltage increase seen on the Fluke 87 from the starting voltage of 24.70 to 24.72 DC volts.





**"FINISH"** Now after approximately **5 Hours** of continuous operation the 24 Volt battery bank voltage has dropped from the starting voltage of 24.70 to 24.59 Volts DC, a **total decrease of .11 Volts DC** , maintaining a constant 140 to 145 + degree F temperature on the "Load Resistor" which is about **5.5 watts** continuous load.



These are the oscilloscopes I used on my Videos, testing and evaluation of this circuit so far ....

### TESTS #1 through TEST #15

**Model - Tektronix TDS3054C**

**Bandwidth - 500 MHz**

**Sample Rate - 5.0 GS/s**

**Record Length - 10 k**

**Channels - 4**



[TDS3000C Digital Phosphor Oscilloscope Series > Products : Tektronix](#)  
[Tektronix TDS 3054C - Operation Manual and Specifications - PDF](#)

### **TESTS #16 through TEST #22**

**Model - Tektronix DPO3054**

**Bandwidth - 500 MHz**

**Sample Rate - 2.5 GS/s**

**Record Length - 5 M**

**Channels - 4**



[MSO/DPO3000 Mixed Signal Oscilloscope Series : Tektronix](#)  
[Tektronix DPO 3054 - Operation Manual and Specifications - PDF](#)

**Model - Tektronix 2445a**

**Bandwidth - 150 MHz**

**Channels - 4**

## **New Build notes**

### **Fuzzy's notes:**

#### **Batteries:**

*"One thing I have looked into is the battery that was used in the original testing for the 24 volt bank was two 10 aH batteries, I'm using a 12 aH, Type 1U (\$38.00 US each) and there is a big difference between the battery that was used in the quantum test. That battery is a 10 aH Type 12 BS which is one of the most common of all type of motor cycle batteries made worldwide and have one (1) more plate per cell than normal batteries for the high inrush amps of "Sport" type motorcycles motor for starting and lighting. This could possibly explain big the difference in the performance from the standard garden tractor batteries Aaron and I used and the high performance 10 aH 12 BS battery (\$89.00 US each) used in the Quantum testing."*

### **Rose's Notes:**

#### **Wires:**

*"We used multiple strands of insulated copper wire"* – stranded insulated wire like thick speaker wire?

No clips – must be hardwired.

The initial leads must be 2 feet long or longer – not shorter.

#### **Other notes:**

Rose never used a printed circuit board but there would be no issue in using one. No other comments.

A 4 channel oscilloscope would highlight phase shifts. Glen and Rose had no phase shifts.

It is probably better to connect the 555 timer circuit across the first 12v battery in the 24 volt battery bank (ground & +12v).

Check that the resistor diameter is in line with Glen's. There is an apparent need to ensure that the 'girth' is wide enough to cope with the 'off phase' of the switch - when it's opened - that there's the 'space' available for that negative voltage spike. I think - if the space is too restricted, that voltage spike is reduced.

The capacitance on the MOSFET is not a serious matter. The IRFPG50 is good to use.

The potentiometer needs to be top quality.

### **Harvey's notes:**

#### **Wires:**

Rose told Harvey that none of her leads were ever longer than 12", but Glen's are quite a bit longer than two feet.

**Other notes:**

*"The inductance of the lead wires definitely play a part in the observed waveforms. However, they also may be part of the reason that so many of our tests did not show the gains because that inductance is directly connected with the AC seen in the current sensing circuit.*

*If you'll recall, I pushed to get probes that are specifically made for current but Rosemary stopped that cold by stating we had imposed on the good graces of our suppliers much too much already. I am convinced that the wire inductance is a large factor in why our battery voltage shows transitions from 24 volts down to 7 volts in the data dumps. I just don't think the batteries themselves are loading that far, it has to be a voltage drop across the wire impedance.*

*If this is the desired effect she is looking for, then I suggest to keep the lead wires as short as is physically possible and simply add an inductive choke in series with them with a value engineered to produce the effect. At least that way you will be working with known values and the effects will be predictable and able to be easily simulated."*

### **Tektronix "Open Choice Desktop" Software**

The Images and test data from Test #17 through Test #22 was acquired using a **Tektronix DPO 3054** Oscilloscope and downloaded with software supplied free by Tektronix called "Open Choice Desktop" with Visa directly to you computer via a **USB** cable from a 2.0 compliant port.

Using this software for data analysis is "great" the type **.csv** file used the data actually includes a exact color copy of the wave form image the data came from just by opening the **.csv** file up using the "Open Choice Desktop" with Visa software. It's quite a large software file about 117 MB but the image data is incredible and a extremely useful addition.

### **OPENCHOICE DESKTOP APPLICATION TDSPCS1 v1.8**

[OPENCHOICE DESKTOP APPLICATION TDSPCS1 v1.8 > Software Downloads : Tektronix](#)

COMPUTER REQUIREMENTS- PC equipped with Windows 2000, XP PRO or Vista 800+ MHz, 500MB RAM, HD, Mouse, Keyboard. Connected by GPIB, USB, RS232 or LAN to a compatible Tektronix oscilloscope. VISA (Virtual Instrument Software Architecture) must be installed on the PC for OpenChoice Desktop to work collecting actual data from a compatible Tektronix oscilloscope. Please read the Instructions on this web page to get an appropriate version of VISA for data collection.

### **Harvey's R and D**

**Back to Basics**

After wasting most of the day yesterday dealing with timing errors in my Spice simulator and getting no where I decided to take a break from it today and catch up on some reading etc.

I see that there are still some experimenting with the RA circuit and the questions regarding energy gains persist. The test of choice used to demonstrate energy gains was [Test #13 \(data here\)](#) [thanks to Rapid Share we have lost our Forum images for display] but I have uploaded the table of interest to my forum gallery for linking:

#	TIME	TEK COV	TEK PNA	AMBIT	Loop VOL	Modest	SHUNT
1	15:00 DMM 24.80	40.000 2.001	000 001	72.5	130	161	110
2	15:06 DMM 24.78	40.002 2.003	002 003	72.5	137	160	107
3	15:12 DMM 24.79	40.004 2.005	004 005	72.9	139	161	109
4	15:18 DMM 24.79	40.006 2.007	006 007	72.7	140	164	110
5	15:24 DMM 24.78	40.008 2.009	008 009	72.6	140	165	102
6	15:30 DMM 24.77	40.010 2.011	010 011	72.5	139	162	112
7	15:36 DMM 24.78	40.012 2.013	012 013	72.5	138	161	104
8	15:42 DMM 24.78	40.014 2.015	014 015	72.5	138	161	107
9	15:48 DMM 24.77	40.016 2.017	016 017	72.5	138	162	109
10	15:54 DMM 24.77	40.018 2.019	018 019	72.5	137	158	114
11	16:00 DMM 24.77	40.020 2.021	020 021	72.5	137	156	107
CHANNEL-1			022				
CHANNEL-2			023				
CHANNEL-3			024				
CHANNEL-4			025				
DCMS			026				

[Click Here For Full Image](#)

Looking at the Temps we see that the resistor temp ranges from 130°F to 140°F. Now we see the average of those 11 readings as 137.55°F and the mode is split between 137°F and 138°F.

Looking at the [resistor DC baseline](#)

24.0 VDC " 10-ohm QUANTUM PROTOTYPE " TEMPERATURE LOAD TEST

Prepared By: \_\_\_\_\_ Initials: \_\_\_\_\_ Date: \_\_\_\_\_  
 Approved By: \_\_\_\_\_

© WILSON JONES      07106 ColumnWrite II

VOLTS "DC"	AMPS	10Ω R <sub>F</sub>	AMBIENT °F	WATTS
4.8	.50	107	73.5	2.40
5.0	.52	110	73.8	2.60
5.2	.54	114	73.9	2.81
5.4	.56	116	73.8	3.02
5.6	.58	118	73.6	3.25
5.8	.60	120	73.8	3.48
6.0	.62	122	73.9	3.72
6.2	.64	125	73.8	3.97
6.4	.66	128	73.9	4.22
6.6	.68	131	74.1	4.49
6.8	.70	134	74.1	4.76
7.0	.72	137	74.2	5.04
7.2	.74	139	74.3	5.33
7.4	.76	142	74.7	5.62
7.6	.78	146	74.9	5.93
7.8	.80	148	75.0	6.24
8.0	.82	153	75.0	6.56
8.2	.84	155	74.9	6.89
8.4	.86	157	74.5	7.22
8.6	.88	159	74.5	7.57
8.8	.90	164	74.6	7.92
20.0	2.05	323	73.8	41

We see this corresponds to ~7.1V @ 0.73A or 5.183W on average. Notice that the voltage divided by the amperage is less than 10 ohms at that temperature and is really about 9.73 Ohms.

Looking at the gate pulses of Test 13, we find that the circuit adopts a duty cycle of about 50%, but what is it really? Let's look at the data:

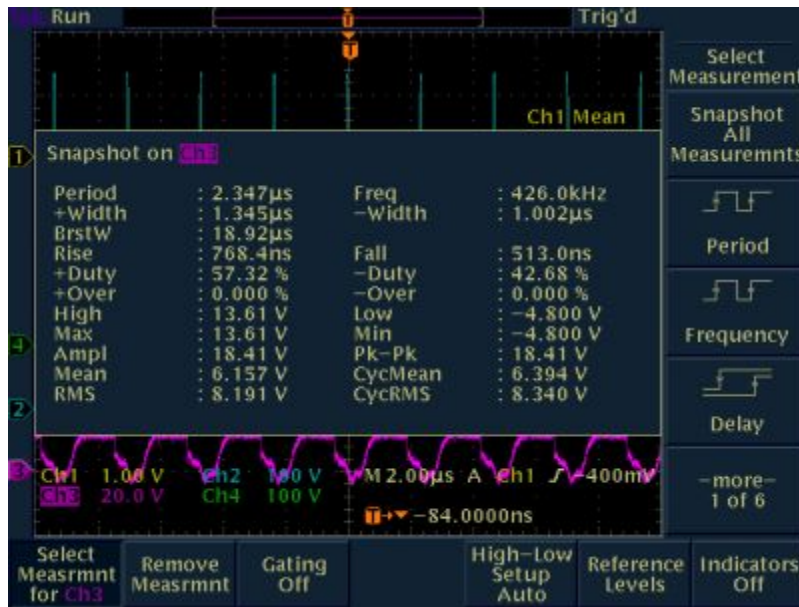

[Click Here For Larger Image](#)

So we see the on period of our MOSFET is really a bit more, 57.32%.

### Now for how this all ties together:

We are comparing small whole apples to big sliced apples (or even oranges for that matter). In other words, we have 7.1V @ 0.73A 100% (small whole apple) and we want to know how that relates to 24.77V @ ???A 57.32% of the time. Now we need a leap of faith - we must believe that the resistance is the same in both cases, 9.73 Ohms - it may or may not be, but let's plug it in and find our current.  $24.77V / 9.73 \text{ Ohms} = 2.55A$  but wait, we have more resistance to add. The MOSFET is 2 ohms when on and the CSR is 0.25 Ohms - So the current is really  $24.77V / (9.73 + 2 + 0.25) = 2.07A$ . But that is only 57.32% of the time. So the power is  $2.07A^2 * 9.73 \text{ Ohms} = 41.69W$  times 0.5732 (for the duty cycle) and we get **23.90W** aperiodic operation.

That is just a basic analysis - how could it be that we are getting such a low heat if we are consuming such great power? Something isn't right. Clearly, a *DC analysis simply fails* to give the correct answer.

Remember the leap of faith? Did that set off any RED ALARMS? It should, because that is where the analysis breaks down. The resistor is more than a resistor, it is also an inductor and it has impedance relative to the frequency of operation. So its true resistance to current flow is greater, and our current will be less accordingly.

Here are some questions to answer regarding Test #13:

What is the frequency?

What is the impedance of the load resistor?

What is the real power being dissipated?

How does a square wave affect the impedance of an inductor?

If the resistor was non-inductive, would the frequency make any difference as long as the duty cycle remained constant?

A DC treatment of the data obtained led us to believe that we were only using 1.3W and that the power dissipated was equivalent to that of 5.18W - does this seem reasonable? That is a gain of 398%. Clearly we need to identify how we get from 23.90W to 1.3W and we need to understand how we keep the heat. Clue: Perhaps there is AC power in the system

## **Back To Basics Part 2 : The First Half Of The Transaction**

### [Mosfet Heating Circuits](#)

Nah, I wouldn't do that to you guys so here come the answers:

## **Here are some questions to answer regarding Test #13:**

### **What is the frequency?**

That depends on what part of the circuit we look at. But generally we use the gate pulse frequency:

426.0 kHz

Rise 768.4ns

Fall 513.0ns

High 13.61V

Low -4.800V

### **What is the impedance of the load resistor?**

The classical formula for impedance of an RL circuit is  $Z = \sqrt{R^2 + X^2}$

$R = 9.73$

$X = 2\pi fL$



$$2\pi = 6.28$$

$$f = 426000$$

Now for L we need to determine the inductance in Henries:

The formula for inductance of a single coil winding in *microhenries* is  $(r^2N^2/9r+10l)$  (For reference, one inch = 25.4mm)

$$r = (32\text{mm} / 2) / 25.4 = 0.625"$$

N = 48, the number of windings

l = length of all the windings and spacing. 20 AWG = 0.032" = 0.8128mm thick, so the length =  $(48 * 0.8128\text{mm} + 47 * 1\text{mm}) / 25.4 = 3.39"$

$$\text{So, L in Henries} = ((0.625^2 * 48^2) / ((9 * .625) + (10 * 3.39))) * 10^{-6} = ((0.390625 * 2304) / (5.625) + (33.9)) * 10^{-6} = (900/39.525) * 10^{-6} = \mathbf{0.00002277H}$$

So,  $X = 6.28 * 426000 * 0.00002277 = \mathbf{60.92\Omega}$  (That is the inductive reactance of Glen's resistor at that frequency)

$$\text{So, } Z = \sqrt{(9.73^2 + 60.92^2)} = \mathbf{61.69\Omega}$$

With this information we can also determine the Phase Angle of the current in this inductive resistor using the formula:  $\theta = \arctan(X/R)$ . For Glen's resistor, we expect the current to lag the voltage by 80.92°

**What is the real power being dissipated?**  $P = I^2R$  |  $I = E/Z$  |  $E = (24.77 / (Z + 2 + 0.25)) * Z = 23.90V$

So,  $I = 23.90 / 61.69 = 387\text{mA}$ . Thus the real power dissipated is **1.46W**

**What is the apparent power involved, yet returned?**  $P = I^2X$

So,  $387\text{mA}^2 * 60.92\Omega = 9.14 \text{ volt-amps}$ . ( I added this question here)

**How does a square wave affect the impedance of an inductor?** This was a trick question - Inductors do not have impedance unless coupled with capacitance or resistance. However, inductors do have [impulse response](#) and reactance, both of which can be affected by the slope of the waveform. This was introduced here to get people to understand that there is more happening here than even a basic classical AC approach can address. The risetime and falltime of the waveforms associated with the inductive-resistor play an important role in the actual instantaneous reactance.

**If the resistor was non-inductive, would the frequency make any difference as long as the duty cycle remained constant?** No, the power relationships remain the same

regardless of frequency as long as the duty cycle remains constant in purely resistive applications.

### **So when is power delivered from the battery to the load?**

This is when the gate pulse is at a positive voltage relative to the MOSFET source pin. Note that there is a low voltage reading of **negative** 4.8V on the gate pin. We don't have the MOSFET Source pin value recorded in the screen shot to go with that, but we do have the data dumps and we could look up what the source reading was when the gate was at that level. This may be an interesting exercise for you to do as it can enlighten you as to how a 555 timer can allow a **negative voltage** to occur on the output pin 3 and where that negative energy comes from.

We find then, that when we apply the classical AC (or pulsed DC) treatment to Glen's Test #13, we expect to see a power dissipation of 1.46W and an overall power swing around 10.6W which is mostly apparent power. This is much closer to what the actual data showed, with a true average of 1.3W when we include the high resolution 2 $\mu$ S/div data, with the lower resolution 40 $\mu$ S/div data. Each of these samples were averaged independently, and then all of those averages were averaged together to reach 1.3W. That is about as true as we could get considering the entire test covered a full hour and we only have 0.00462 seconds (4.62ms) of data for the entire test. A lot can happen in the other 3599.99538 seconds we have no data for. **Sure would be nice to have an RSA6000 to get some seamless data with.**

Now this puts us back to asking the **question**: If we are only showing, both by projections and by data, ~1.5W of dissipation, how do we account for the 5.5W of thermal output?

### **Back To Basics - Part 3: The Other Half Of The Transaction**

I have the utmost confidence that those following my last two post regarding questions for Test #13 will have realized that so far I have only covered half of the AC transaction - the positive half of the cycle. So far we have discussed the dissipated power in the load resistor that we can attribute to battery power being delivered to it. However, we all know that there is more to the story. We have 9.14 volt-amps of apparent power involved that we really haven't given a fair hearing.

We know, that after a period of time that the MOSFET is in the ON condition, that conventional DC current flows through the load resistor and if allowed to continue long enough, that resistor will charge magnetically in the inductive winding it possesses. This means that it becomes a DC solenoid and a magnetic field surrounds it with a B vector running straight through its center lengthwise.

**How long does it take to build the field and how much energy is stored in the field?**

There is a relationship between the electrical current and the building of the magnetic field. At time zero (0t) when we first turn on the MOSFET, 100% of the current is not yet flowing. At time one (1t), 63.2% will be flowing, leaving 36.8% not yet flowing. At 2t, an added 63.2% of the *remaining* 36.8% will be flowing leaving 13.54% of the overall current not yet flowing. At 3t, an added 63.2% of the *remaining* 13.54% will be flowing, leaving 4.98% not yet flowing. At 4t an added 63.2% of the *remaining* 4.98% will be flowing, leaving 1.83% not yet flowing. And finally at 5t an added 63.2% of the *remaining* 1.83% will be flowing, leaving 0.675% not yet flowing. So, after 5t we find that our current is flowing at 99.33% of its total value - therefore we generally consider an inductor to be fully charged after 5 time constants. You can go to infinity and it will never reach 100% because each addition of current flow is always 63.2% of the remaining amount. The formula for the foregoing is  $I_t = E/R (1 - e^{-tR/L})$  where e is the natural log constant 2.71828. This resolves down to each time constant,  $t = L/R$  seconds. This is good for us, because we know the  $R = 9.73$  ohms from Glen's Baseline profile test and we know the L in Henries from *Back To Basics Part 2* as 0.00002277H. Therefore, we can easily calculate how long it will take for our inductor to reach maximum current flow.

Time in seconds to full charge =  $5 * (L / R) = 5t$

$5t = 5 * 0.00002277 / 9.73$

$5t = 2.34\mu s$

So that answers our first question - Glen's resistor is fully charged after 2.34 $\mu s$  from the MOSFET coming into full conduction. I looked up the stats on the IRFPG50 just for grins here and the turn on delay for this device is 19ns with a 35ns rise time under the test conditions of max current and Vdd = 500V. But we can probably safely say that from the time the gate goes high, the inductor is fully charged 2.394 $\mu s$  later.

Now for the second question as to how much energy is stored in that inductor if we fully charge it.

[Energy Stored in an Inductor](#)

[Energy Stored in an Inductor](#)

From this we learn that the energy stored is  $1/2 LI^2$ . So in Glen's case it is  $0.5 * 0.00002277 * 0.387 * 0.387 = 0.000001705120065$  J or 1.7 $\mu J$ .

**So if we are operating at 426kHz, how long do we have DC current building the field?**

That one is easy. Our full cycle time is the reciprocal of our frequency, therefore a complete cycle is  $1/426000$  seconds long, or 2.34 $\mu s$  long and our ON period is 57.32% of

that or  $1.35\mu\text{s}$ . In test #13, the inductor does not fully charge. If a full charge is  $2.34\mu\text{s}$ , then  $1\tau$  is  $0.468\mu\text{s}$ .  $1.35 / 0.468 = 2.9\tau$  or 94% Charged. We might add here that this means our stored energy is only  $1.6\mu\text{J}$  then.

So this brings us to the other half of the transaction, the half where we turn off the MOSFET. And this is also where things change and must be analyzed differently. At this point we have  $1.6\mu\text{J}$  stored in the inductor as a magnetic field and we take the gate terminal low. The IRFP50 has a turn off delay of  $130\text{ns}$  and a fall time of  $36\text{ns}$ . So we can expect at  $166\text{ns}$  delay from the time we signal it to turn off to the time the inductor begins to collapse its field. This can be seen in the screen shots and the actual delay can vary depending on residual gate charge that is not scavenged away by the 555. We find that typically, the field is fully collapsed about  $234\text{ns}$  later. So it charges in  $1350\text{ns}$  and discharges in  $234\text{ns}$ . At this point, the field is fully collapsed and has been converted to a voltage potential commonly referred to as a BEMF spike, at the drain of the MOSFET. There is a difference between BEMF and CEMF. BEMF is a voltage which when allowed to act on a circuit will cause a back flow of current after the magnetic field is fully collapsed. CEMF on the other hand, is a voltage which acts against, or counter, to an incoming voltage of opposite polarity in an AC system and causes a clash of currents. Simply put, the BEMF occurs when a switch stops current flow, CEMF occurs when the power supply polarity is reversed. So now, we are at the time where our BEMF spike is at its maximum potential. The MOSFET is OFF. The voltage can only flow through one path, it must turn around and flow back into the load resistor. This point is very important: *The BEMF seeks to distribute itself evenly throughout all the conductors connected to it.* In this case, the conductors become charged evenly (given the time to fully distribute).

### **So how much voltage would we expect in the BEMF pulse?**

Interestingly, this depends on how fast the field is allowed to collapse and how much energy is stored in the field. We can use this formula:  $E = -Nd\Phi_B / dt$  where  $N$  is the number of turns (48) and  $\Phi_B$  is the flux density in Webers and  $E$  is the electromotive force. Now, the thing to keep in mind here is that the electromotive force is across the coil, not across the battery. But how do we determine what our Webers are? One simple way is to relate it to the Joules we have already determined. A Weber is the same as Joules divided by Amps. Now doing it this way can introduce a compound error if we have made any mistakes in determining the Joules and good practice would demand that we use another approach so that we can compare the results. Perhaps someone would like to double check me on this by using another means like  $\text{m}^2 \cdot \text{kg} \cdot \text{s}^{-2} \cdot \text{A}^{-1}$ . For now, let's use the easy way. So we have  $1.7\mu\text{J}$  and  $387\text{mA}$ : This gives us  $0.000001705120065 / 0.387 = 0.000004405995$  Webers, or  $4.405995 \mu\text{W}$ . So now we can get back to our equation:  $-N \cdot d\Phi_B / dt$  where  $N = 48$  Turns,  $d\Phi_B = 0.000004405995$  Webers to Zero (that is our change in flux) and  $dt = 0.000000234$  Seconds (that is our

change in time). So what is our result? -903.79 Volts.

Now to explain the negative in that equation: Remember my comment above that I said was important to remember? The -903.79V is across the coil and tells us something according to Lenz's Law and that is why there is a negative on there. When the field collapses, the voltage is negative with reference to the voltage that created the field. Recall that we had a positive voltage of 23V across the coil when we created the field, and now, leaving our measurement equipment in the same place, we will see a negative voltage across the coil. How does this relate to the Battery? Well, for one thing, our Battery is our point of reference in Glen's data gathering. And we have the interesting condition where our point of reference is isolated from the coil by the OFF condition of the MOSFET. Additionally, the very place we expect a negative nine hundred and three volts we leave that connected right to the Battery Positive. Now, we are either going to drive that B+ down 903V or the other end of the coil is going to go up 903V but one way or the other we are going to see -903V across that coil. Well, as reality would have it, the Battery holds its own and clamps that end of the coil at our 24.77V relative to B- and this means the floating end (Drain connection) of the coil will go up to a +903.79V + 24.77V for a grand total of +928.56V relative to Glen's ground reference.

### **How much real dissipated power can we expect from the BEMF Spike?**

This is where things get interesting, because now we are 400ns into our MOSFET OFF period and at the peak of our BEMF spike. What will happen next? We have 1.7μJ of energy sitting on a small section of wire between the coil and MOSFET Drain just chomping at the bit to go somewhere. Recall that I said earlier that the BEMF spike is looking to distribute itself equally over the conductors attached to it. When it does, current flows back from the small piece of wire there, through the coil, to the battery plates. But this transaction is not happening at the lazy frequency of 426 kHz. No, this is where the slope of that falling voltage changes all of the dynamics. The fall is so fast, that to our coil it looks like a 2.5MHz signal (400ns wavelength) Now we have to go back to square one and recalculate our inductive reactance using that frequency to know what our impedance will be during the return trip, so we can determine our current flow and thus our power dissipation in the resistor.  $X = 2\pi fL = 6.28 \cdot 2500000 \cdot 0.00002277 = 357.67\Omega$ .

$Z = \sqrt{R^2 + X^2} = \sqrt{9.73^2 + 357.67^2} = 357.80 \Omega$ . To determine the amperage, we now take our 903.79V / 357.80Ω and we get 2.53A. Now we can determine how much of that is dissipated from  $I^2R$ ,  $2.53^2 \cdot 9.73 = \mathbf{62.08W}$ . Is that real power? Yes, but it is peak power of a sinus waveform and is reduced to zero watts over a 100ns period. So the RMS value would be  $0.707 \cdot 62.08$  for that 100ns period, or **43.89W**. Now, it would seem reasonable to double this time, because we have to apply this same value while we are building

the BEMF spike - in that case, it would be for 200ns for both the rise and fall of the BEMF spike.

So how does this work out for one full cycle? We have 1.46W during the entire ON time and we have 43.89W during 200ns of OFF time and relatively zero watts during the other 0.974µs of OFF time. This comes out to an average of **4.47W** of real power dissipation for each full cycle of the MOSFET. So we are still about 1W short of the thermal output recorded during the test – where does that extra energy come from?

### **Where does the extra watt come from?**

One thing we know about this circuit, is that it is very aperiodic when operating in its preferred mode of oscillation. This means that the frequency is always changing. The calculations I have done in this Back To Basics three part post are on one single cycle, 2.34µs based on a snapshot of the real events. As mentioned in part two, there is a huge area of time that we have no data on and cannot say what is really happening there. We found other spikes in Test #22 that are too narrow to be picked up with the 10,000 sample resolution even at 2µs. So, it could be that the extra watt is buried somewhere in those unrecorded time intervals. The opposite could be argued as well. The unrecorded time intervals could demonstrate that when 100% of the data is collected together uninterrupted that we really may have no classical explanation for where the extra energy is coming from.

I look forward to new tests giving us uninterrupted data capable of proving the case either way. One such test would be an endurance run that exceeds the capacity of the supply. Another test would be to run the device from a monitored power source with a BATCAP filter and a calorimeter cabinet (the entire circuit contained so all thermal energy is counted) – this would be easy to see over an extended period of several hours exactly how the input power relates to the output power.

### **555 timer circuit**

This post to Aaron was discussing the original Quantum (Buckley) Circuit:  
[COP 17 Heater | Rosemary Ainslie](#)

Here was my first post regarding the proposed changes to **prevent the overheating**:  
[COP 17 Heater | Rosemary Ainslie](#)

This Post contain a link to the previous post:  
[COP 17 Heater | Rosemary Ainslie](#)

This is Aaron's acknowledgment of the proposed changes:

## [COP 17 Heater | Rosemary Ainslie](#)

This post was a reminder that a solution to reducing that heating was provided earlier:  
[COP 17 Heater | Rosemary Ainslie](#)

It really isn't a big deal - but it's a simple modification that removes one component, gives better adjustment and stops the discharge heating –End

In this post I would like to address the concerns that most engineers and academics have regarding the mixture of energy from different power sources and the difficulty of keeping these separate during the data acquisition and recording. I have provided 3 different modifications to Glen's arrangement that provide a means of removing the secondary energy source from the circuit and will list the pros and cons of each modification.

First we have Mod A:

Here we have the simple addition of a readily available 7812 voltage regulator to allow the timer circuit to be powered by the 24V Supply directly. However, this modification requires a blocking diode to prevent the >90V inductive BEMF from damaging the regulator which is rated at 35V Max input.

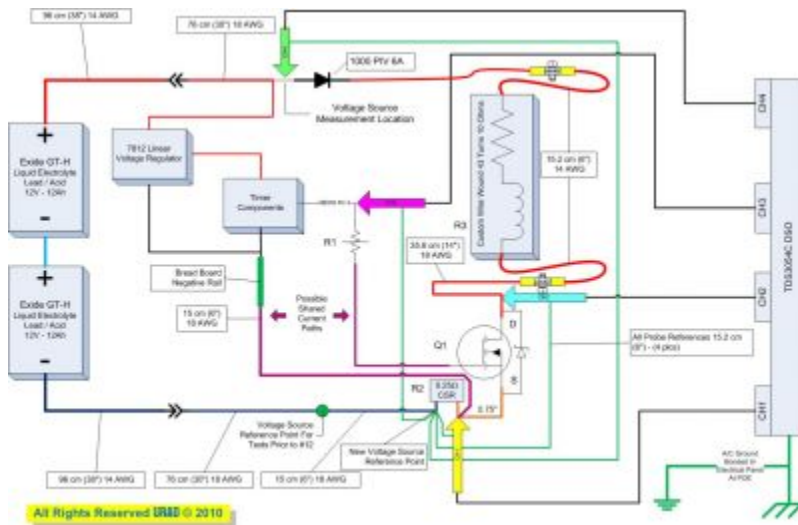

[Click This Link For Larger Image](#)

MOD A Pros:

1. The CSR values represent 100% of the current flowing back to the battery including all Timer related current. Mesh Currents become a non-issue.
2. A more accurate battery power value is recorded as the BEMF is prevented from inflating this measurement

3. Scope probe positioning is retained from previous tests allowing similar adjustment protocols as previously used.

4. COP registrations will increase as all inductive energy is trapped between the blocking diode and the HEXFET forcing the energy to be dissipated in the Load (R3). [this feature requires sufficient time between retriggering to allow full transformation of the energy to heat]

5. Regulator only requires a 2.6V overhead - will work with total battery voltage as low as 14.6V - Good for endurance runs

6. No additional components needed to set regulator voltage.

7. Very large BEMF values on the blocking diode cathode can be withstood, up to 1000V

#### MOD A Cons:

1. The Batteries will not be recharged. The blocking diode forces that energy back to the Load (R3) to be dissipated.

2. Obtaining the Preferred Mode Of Oscillation will be more difficult because the voltmeter reference will always show a discharge commensurate to the actual total energy consumption.

3. The Linear regulator adds to the total energy consumption

4. Addition of the regulator requires involved modifications to the existing circuit

#### MOD A Conclusion:

Use this configuration for high COP accurate energy consumption tests.

#### MOD B:

The Mod B configuration is very similar to Mod A, but uses a High Voltage TL783 Regulator that does not require the blocking diode. However, this regulator does require the addition of resistors to set the output voltage to the desired level.



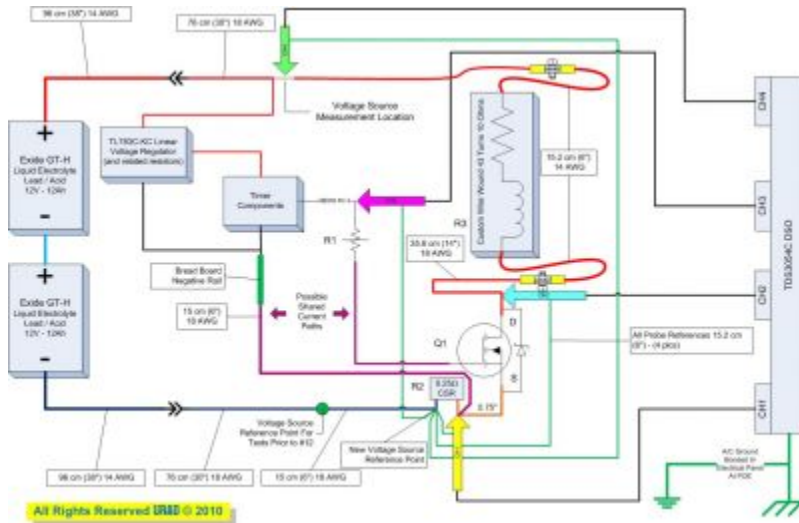

[Click This Link For Larger Image](#)

#### MOD B Pros:

1. The CSR values represent 100% of the current flowing back to the battery including all Timer related current. Mesh Currents become a non-issue.
2. Scope probe positioning is retained from previous tests allowing similar adjustment protocols as previously used.
3. Source Battery is allowed to recharge
4. Obtaining the Preferred Mode Of Oscillation will be essentially unchanged from previous tests
5. Meter connections are retained with the same function as previous tests

#### MOD B Cons:

1. BEMF is allowed to inflate Voltage Source measurements giving a false indication of actual battery consumption.
2. BEMF energy *at the battery* is limited to 125V max
3. The Linear regulator adds to the total energy consumption
4. Extra resistors are needed to set the output voltage of the Regulator
5. COP values will be less than optimum as some of the BEMF energy is used to recharge the battery rather than heat the Load (R3).
6. The regulator has a high dropout voltage of over 21 volts - this limits endurance runs where recharging is unable to exceed or stall consumption.

7. Addition of the regulator requires involved modifications to the existing circuit

MOD B Conclusion:

Use this Mod where battery recharging is desirable along with retaining former equipment configurations.

MOD C:

This is really the most simplistic modification with regards to circuit changes. However, it necessitates a radical departure of the equipment connections and data acquisition.

This is due to the fact that we are using a tapped supply source with two different voltage levels. Each must be properly monitored to accurately calculate the battery delivery power. This requires all four scope probes to be dedicated to obtaining the information required to calculate the total power delivered. Mesh currents are inherently addressed in either of the two branches for any instant in time.

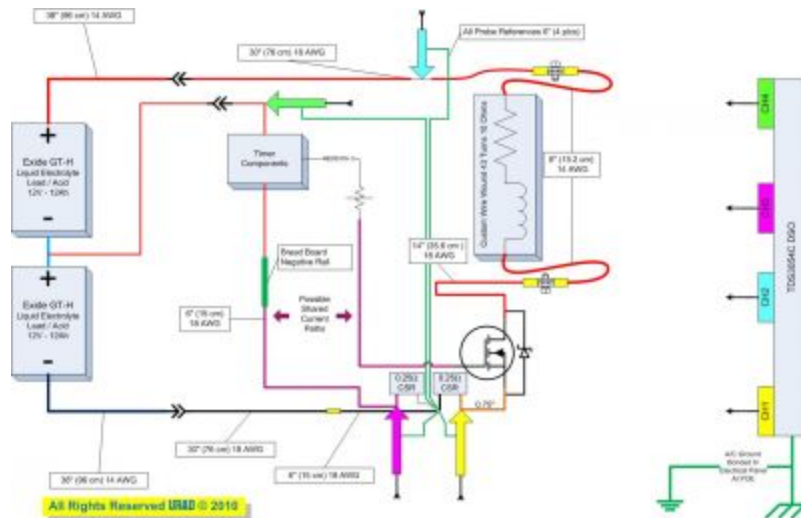

[Click This Link For Larger Image](#)

MOD C Pros:

1. Very Simple modification, no new parts are required as the secondary CSR is already in place from a previous Mesh Current test.
2. Separate data collection for the timer circuit consumption and the Load circuit consumption.
3. No Regulator to add to the energy consumption
4. Battery Recharge is enabled
5. Meter connections are retained with the same function as previous tests.

6. There is no component limit to the BEMF other than HEXFET avalanche and battery plate arcing (which would be very bad - even explosive - maybe this should be a Con?).

MOD C Cons:

1. Major changes in Scope Probe connections and function. We lose the Gate reference and the Drain Pulse reference in our data acquisition.
2. Due to Con#1, obtaining the Preferred Mode Of Oscillation will be very problematic - a separate scope may be necessary to facilitate this function.
3. COP values will be less than optimum as energy is used to recharge the batteries.

MOD C Conclusion:

Use this mod where minimum circuit consumption is desired and a separate record of each branch is needed. A pre-calibrated circuit may be necessary prior to data acquisition. This arrangement would be good for very long endurance runs.

**A real world comparison**

Yesterday I thought to myself "I wonder how Glen's Resistor compares to this heater I have keeping me warm right here"

So, like Nikola Tesla used to like to do, I set out to determine the surface area of my wonderful 1500W "warmth maker". It is one of those oil based systems, organized in a radiator style. It has 6 complete elements of the same size and one larger element that also contains the electronics and plumbing. It also has two connection cylinders that run the length, one on top and one on the bottom, connecting all the elements.

Well after all of my calculations I arrived at a surface area of approximately 14,171 cm<sup>2</sup>. I also have temperature measurements. Surface Temp 169° F and Ambient Temp (taking an average of multiple points around the room) 71° F for a difference of 98° F.

So, where the Ambient temperature is 71° F, my heater offers a 98° advantage with a dissipation factor of 106 mW / cm<sup>2</sup>. How does this compare to Glen's DC baseline? Well, in order to find out I had to build an extrapolation table from his data. You can download the spread sheet from here:

[Glens Resistor Profile](#)

Since Glen's average ambient temperature was 74.2° F, and I am looking for a differential of 98° F, I look up 172° F in the table and find a corresponding power relationship of 8.95W. Now we must spread that out over the surface area of his resistor. His resistor is a 3.2cm x 15.2 cm cylinder with stopped ends (which I take as being

thermal insulators, not dissipators) Now there may be slightly more surface area because of the bubbly nature of the Silicone covering, and it has a larger diameter. So how about we add a couple mm for that and the wire thickness? (I think the wire is 0.81mm) So lets say 3.4cm x 15.2cm for a surface area of  $3.4 \times \pi \times 15.2 \text{ cm}^2$  or  $162 \text{ cm}^2$ .

$8.95\text{W} / 162 = 55.2\text{W} / \text{cm}^2$  for the same thermal advantage of  $98^\circ \text{F}$ . Right out of the gate, with a DC application, Glen's resistor outperforms my AC radiator by almost double, or actually 192% better efficiency in watts per surface area for a given thermal advantage. This all came about after my explaining COP to an interested party wherein I had used the illustration that follows in my next post.

This illustration helps us to see how setting baselines and then demonstrating improvements can still fall short of demonstrating a value to the world. It also causes pause and reflection of the term COP and how it really applies from the global view. I have noticed that some confuse the terms and thought it may be nice to bring some level of definition here.

The 'C' in [COP](#) stands for coefficient. A coefficient is a constant, a specific value, that when multiplied with a variable gives a result. It is a mathematical term and it is found throughout science. For example, your tires on your car will have a traction coefficient, resistors will have a temperature coefficient, and wood can have a friction coefficient.

Unfortunately, some have misread this to say 'Co' meaning shared, 'efficiency'. And it is not uncommon to hear people say it as 'co-efficiency' or even print that in the title or body of their papers and posts. But in reality, it does not have anything to do with efficiency. That is an entirely different subject that should be considered.

The 'OP' stands for "Of Performance". Therefore, a COP is a mathematical constant that is used to give the performance result. The global view of this term COP, relates to heating systems and represents a ratio between how much energy is used to move heat from one place to another and the increase in heat at the result location.

Another illustration: A person had a pile of money in one room of the house and desired to have it moved to another room of the house. So this person asked a neighbor child if they would use their wagon to move the money. The child agreed, and for this the person rewarded them 1% of the money. Can we say that the person spent 1% and gained 99%? Not really, because they were just moving around what they already had. But what can be said, is that for a price of 1% they achieved a result of 99% and that would have a COP of 99. So it goes with thermal energy. Heat pumps take from the pile outside and move it to the pile inside.

So when we use the term COP we really need to tie it to the global view of what we are

moving from where to where. Fortunately, we have established relationships between Watts, Joules and Calories which help us get things right. By the way, it would appear that my 1500W "warmth maker" is the leaky bucket.

### Possible AC

#### **Possible Alternating Current In Current Sensing Resistor Data:**

This is a sticky issue and I have been apprehensive to address it for two reasons.

1. If it exists in the MOSFET heating circuit, then our previous tests need to be analyzed in such a way as to factor it into the equations.
2. It goes against normal logic with regards to simple analysis of DC systems.

But it is a concern that needs to be discussed and addressed. This is what I alluded to in the other thread regarding being able to light a 100W lamp while showing zero CSR current. Below I have 3 drawings showing 4 different circuit configurations. All of which draw attention to specific current flow factors that hopefully will help us to understand better what is happening in this circuit.

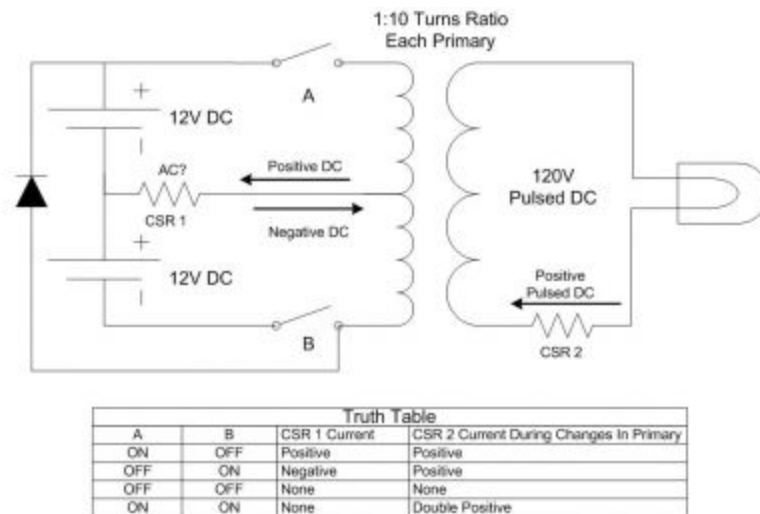

[Click Here For Larger Image](#)

Notice in the above drawing that a primary current will flow when either or both of the switches A or B are closed. Notice also that when both are closed, current does not flow in CSR 1. This is not an AC application, all of the signals are DC. But notice, that if we alternate A and then B that the current in CSR 1 will in fact be AC. If we were to put our CH1 scope probe on CSR 1 for that operation, it would mislead us into thinking we have no source power being used while a probe on CSR 2 would clearly show (as

would the lamp) that we are using power. Also note the all of the BEMF generated in this circuit is utilized.

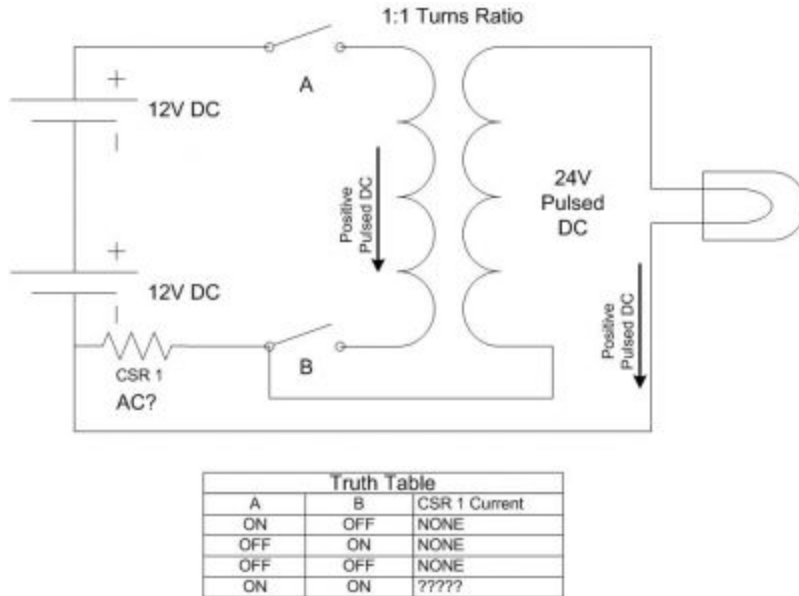

[Click Here For Larger Image](#)

In this configuration we have removed CSR 2 and allowed the power stage to use CSR 1 for its current path. Notice that we are still using pulsed DC here and in this case we do not alternate A and B, but instead must turn them both on to get a transformation. Also, notice that our transformer has a different turns ratio. By convention, the current flowing in the primary will be the same as the current flowing in the secondary. Notice the configuration for the two current paths as they both route through CSR 1. If we put a scope on CSR 1 what will it tell us? Assuming there is no phase lag in the transformer, will it show any current flow at all? What does this tell us regarding secondary currents being mixed with primary currents in sensing resistors?

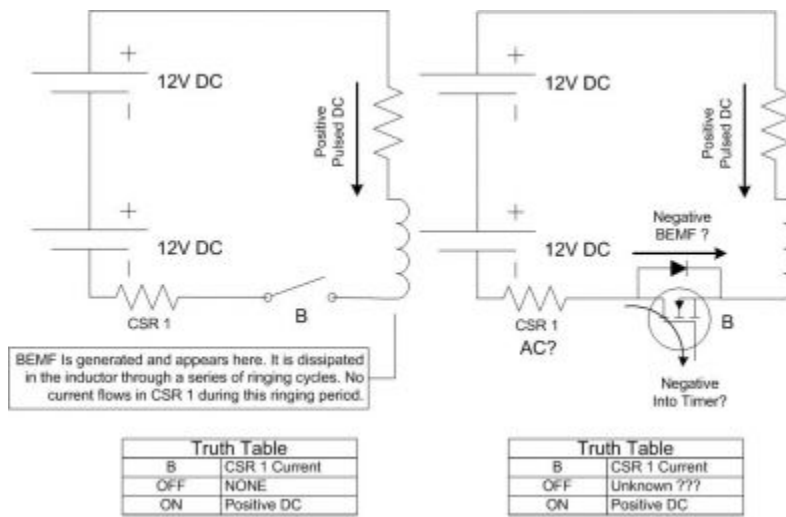

[Click For Larger Image](#)

Notice in the image above we have two nearly identical circuits. Some of you will recognize this as being very similar to the MOSFET Heating Circuit. Notice again that we are working with DC. Because switch B in the left diagram causes an open circuit configuration at the end of an on cycle, no current can flow in CSR 1. This however does not prevent the BEMF from accumulating at its contacts when the inductor discharges. What happens to that energy? It rings back and forth as Alternating Current in the inductor itself until it is fully dissipated. If we put a scope on CSR 1, it will tell us nothing of the BEMF ringing.

In the Image on the right, we have replaced switch B with a MOSFET. Now we have introduced two new things that are not present in the left side diagram. First, we now have a current path around the switch in the opposite direction. We also have a capacitive pathway through the gate of the MOSFET into the timer circuit that drives it. Now, when we place a scope on CSR 1 and see a negative current, we don't know if it is flowing through the diode or through the gate, or both. What is more, we don't know if it is being sourced by the batteries or by the inductor as they are all mixed together now - remember the second drawing we looked at earlier?

One of the arguments that has been used, and I will admit I have used it, is that all of the energy in the circuit must be coming from those 3 batteries in the circuit and as long as there is only one path in or out, then all of the current must be flowing through that path. However, we may be making some large assumptions with that argument. First, consider that current must be flowing in the inductor during its ringing as shown in drawing 3 left diagram when switch B is open, but no current flows in the 'path' to and from the batteries. Next we need to consider open loop discharge. In [this video](#) I demonstrate that BEMF can be dumped through a single wire with sufficient current to

light an LED and no conductive return path back to the coil that generates the BEMF. So this raises the question as to whether or not secondary currents can cause misreading if they are allowed to discharge through our sensing resistor in some manner.

When dealing with any new technology, or even when revisiting old technology that deals with proposed violations of known laws, it becomes very important to eliminate any possibilities that can skew the data or be taken the wrong way. This is especially true when the technology is difficult to reproduce and unable to be demonstrated by conventional means. I hope that in the coming posts we can devise some tests that will prove conclusively what the truth is surrounding this proposed technology.

### **Tests 17 - 22 Data Analysis**

#### [Mosfet Heater Tests 17 - 22 Data Analysis](#)

End

With the Help of Peter, Harvey and Aaron the following simple 555 timer circuits was developed that can produce the right frequency and duty-cycle drive for the MOSFET. You are able to set the ON TIME of the drive circuit to 16 microseconds and the wavelength to about 416 microseconds which gives a 2.4Khz square wave with a 3.7% duty-cycle. Considering that we don't know anything and only have dirt and twigs to work with, it wasn't that hard.

There are two circuits which are being currently experimented with. It is the intent to recover 95% of the energy and charge an additional battery whilst operating the circuit. WATCH THIS VIDEO FIRST

[YouTube - Quantum Magazine 555 Circuit Test on Rosemary Ainslie's COP 17 Heater Circuit](#)



# Rosemary Anislie COP 17 Heater Circuit

THIS CIRCUIT GIVES  
FULL NEEDED RANGE  
OF DUTY CYCLE  
AND FREQUENCY

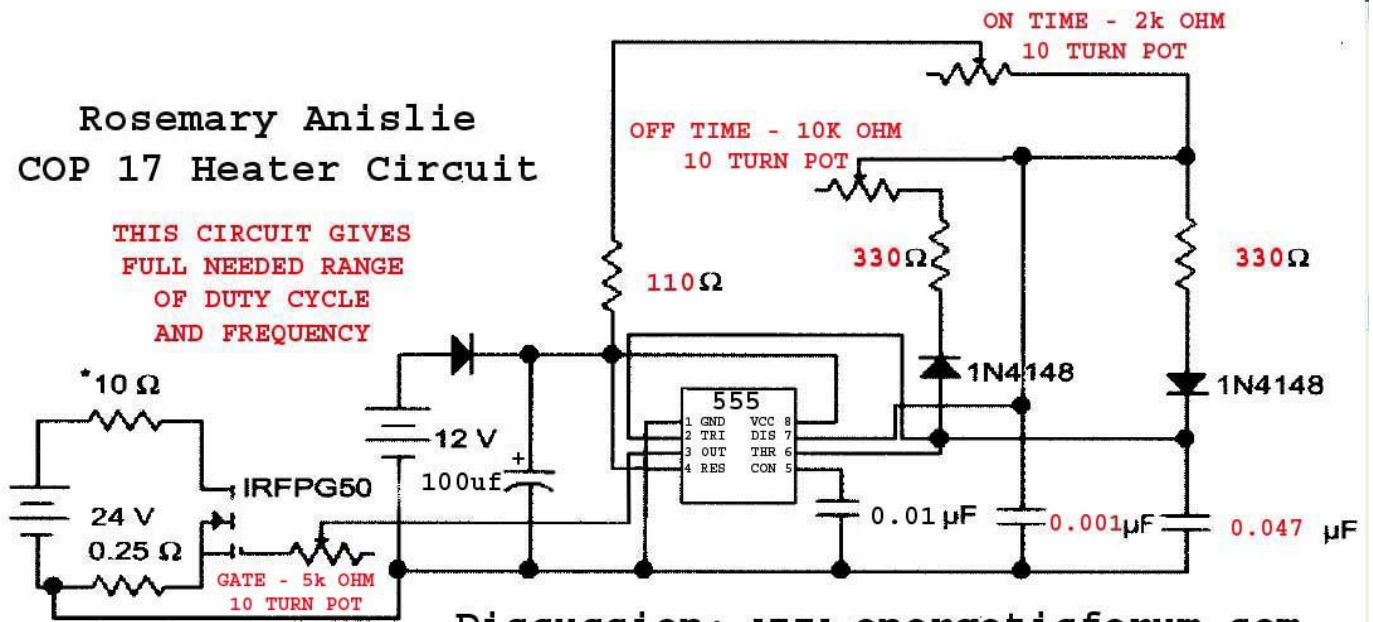

Discussion: [www.energeticforum.com](http://www.energeticforum.com)

Figure 1: Circuit diagram

REVISED: AUGUST 12, 2009

The values on the timer circuit may be different and I have a pot between the battery and the timer circuit positive to vary how much power I want it to have. And I have the timer powered by the same battery as the load. The 10 ohm resistor on the left side of the circuit is an inductive resistor.

Rosemary Anislie  
COP 17 Heater Circuit

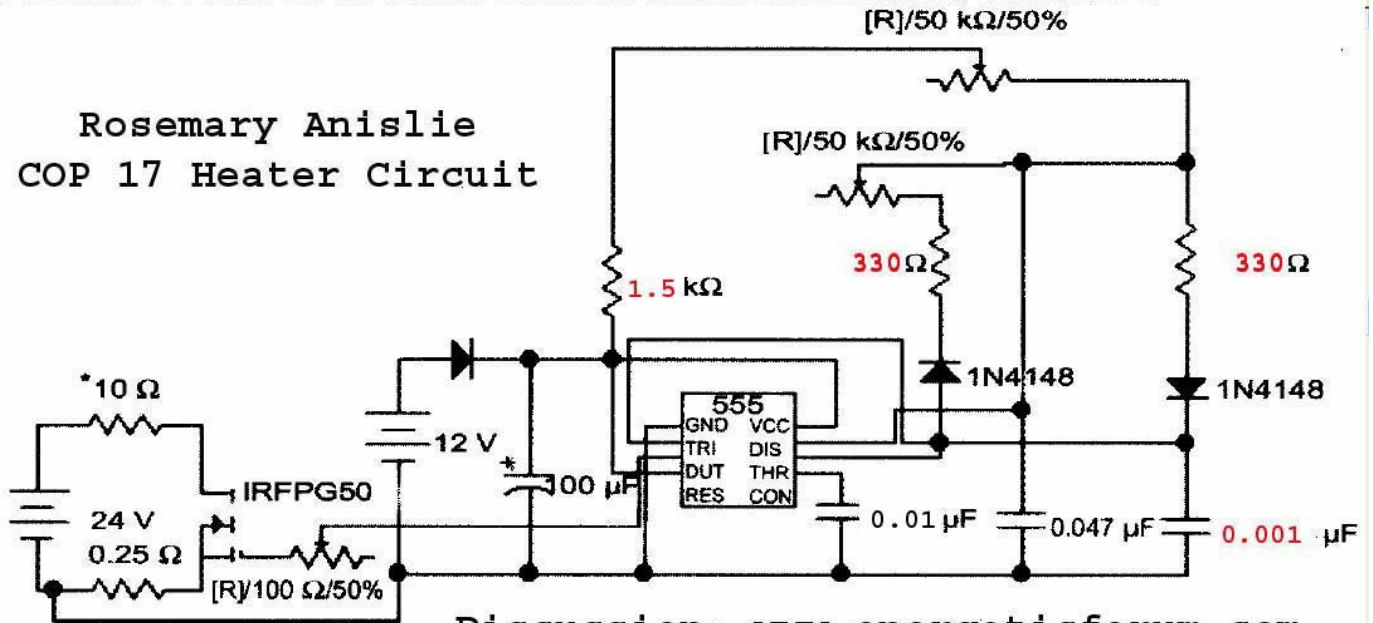

Discussion: [www.energeticforum.com](http://www.energeticforum.com)

Figure 1: Circuit diagram

Revised August 9, 2009

Tune the circuit to resonance for highest gain - it will go into high speed self oscillation when increasing ate resistance but you need to play with the duty cycle and frequency. Here is a picture of what it should look like:

**SCOPE SHOTS OF  
ROSEMARY AINSLIE'S CIRCUIT  
WITH QUANTUM ARTICLE CIRCUIT**

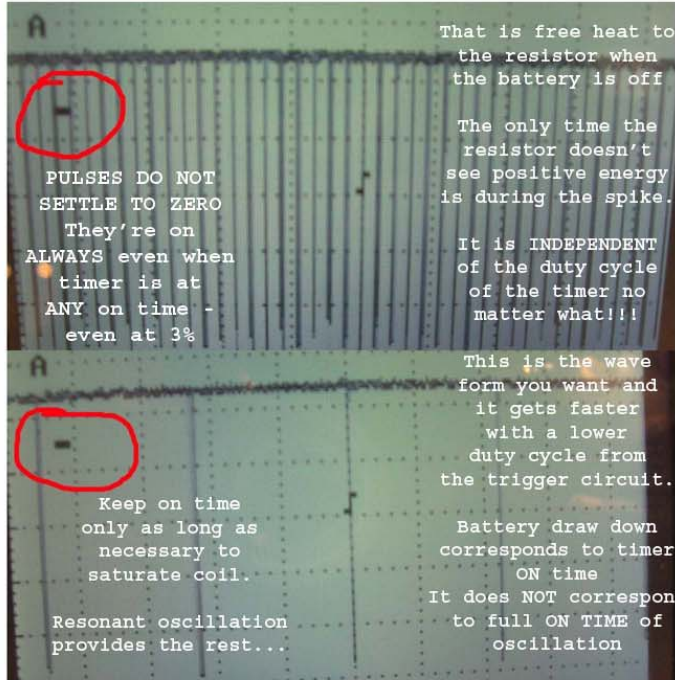

Above - shots of shunt during oscillation  
Does NOT go to ZERO VOLTAGE.  
SPIKE - ON - SPIKE - ON - SPIKE - ON

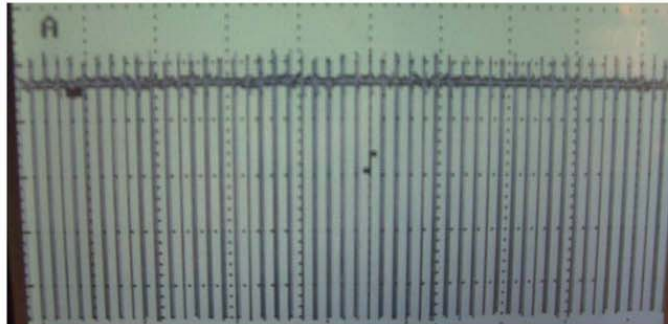

Across load - massive spikes

These oscillations are from the  
Quantum Article circuit.

There are aperiodic waveforms, just  
"2 legs" or so easier to see in person.

When Quantum circuit is modified for low  
duty cycle, better results will be expected.





Thanks to Alex, Glen and Luc.

### 10 Ohm Resistor by Glen



I just finished my "Borosilicate Glass Tube" (Pyrex) 10 Ohm Wire Wound Resistor, it's specifications are - 32 mm OD. x 6 inches long, 48 turns of AWG 20 [.032 dia] ( .6348 ohms ft ) "Ni Cr A" 80% nickel, 20% chromium resistance wire. The outer covering is "Permatex" Red High Temp RTV Silicone - Continuous Operating Temperatures °C (°F) -54 to 316 (-65 to 600) [Red High Temp RTV Silicone #81409](#) . Here are some photos of my "Barbecue" coil winder; the last photo is with string removed and RTV silicone covering.



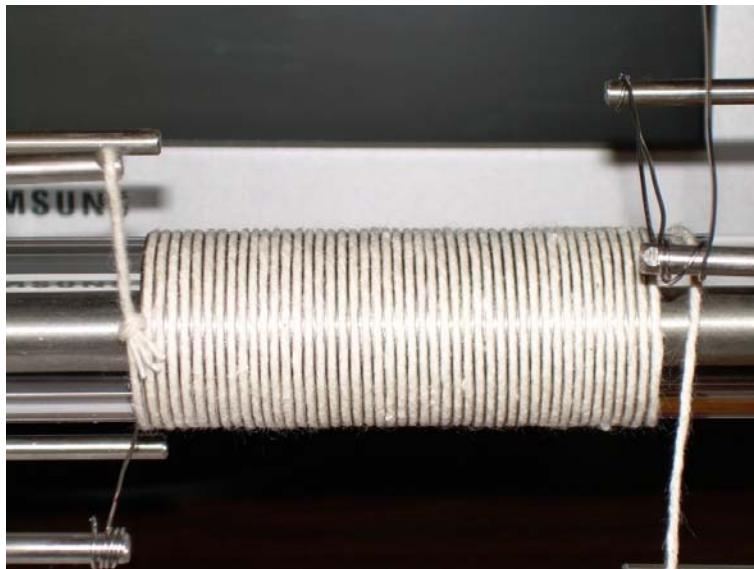
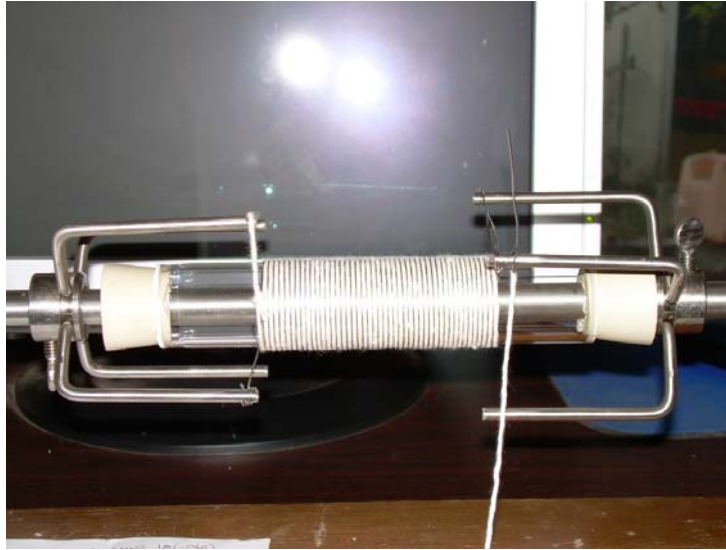

The Red High Temp RTV Silicone #81409 is available at any auto parts store. The "Borosilicate Glass Tube" ( Pyrex ) 32 mm OD. x 6" long comes in a 5 foot length and has to be cut using a diamond tipped wet saw like is used for cutting ceramic tile or marble ( most tile retailers have saws and do cuts for a small fee ) and is available at most "glass" or "lamp working" suppliers like :

[Mountain Glass Arts, Inc. - Lampworking, Glass blowing and Bead Making supplies](#)  
[simax meduim wall 32mm \(25\)](#)  
[simax hvy 32mm \(25\)](#)

It is fairly reasonably priced each stick. I used a wire wound resistor a "Dale" RS-2B .25 ohm 3 watt 3 %

<http://www.diyparadiso.com/component...dale%20rs5.pdf>

Purchased From -  
[Surplus Sales of Nebraska](#)  
[Wire Wound Resistors - 0 Ohm to 0.499 Ohm](#)

A Great Surplus Electronics Supplier.

**Aaron's 555 Timer Circuit for Rosemary Ainslie's Circuit**

The Following is a clearer schematic of what Aaron is using. Original comments - It works and has great variability depending on what you want to do. Any inductive resistor you put on this can be tuned to its own resonant frequency with this timer circuit. Gate resistor tunes the ringing. I don't know any common item with these inductive resistors. Check Ebay, Mouser, Digikey, etc... Ohmite and Clarostat brands are the two best. The Clarostat's seem to have much more inductance for the same rating.



Rosemary Anslie  
Circuit Replication

3.7% duty cycle  
and 2.4 kHz is  
only a guideline!

Each circuit will  
have its own  
resonant frequency(s)

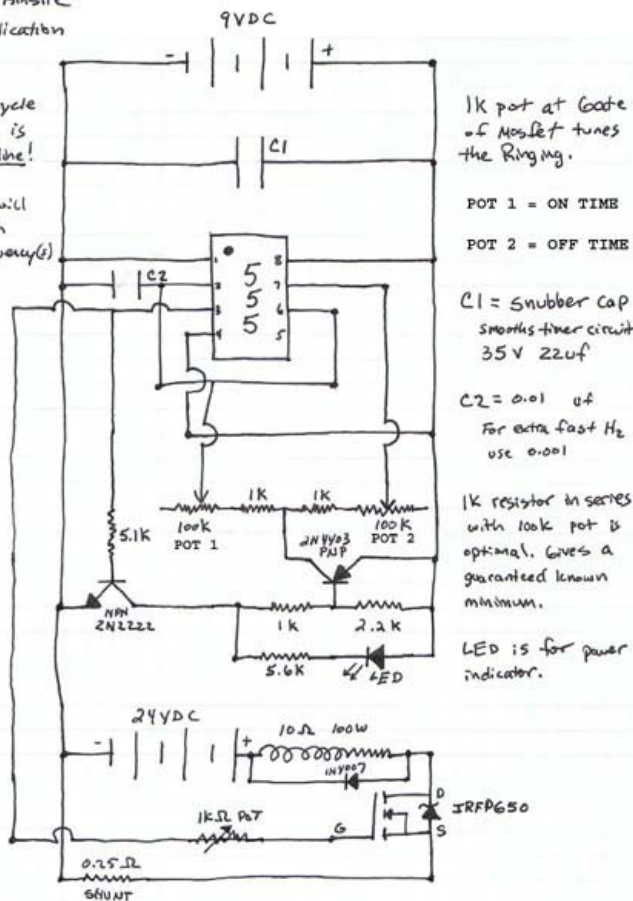

1k pot at Gate  
of Mosfet tunes  
the Ringing.

POT 1 = ON TIME  
POT 2 = OFF TIME

C1 = Snubber Cap  
Smooths timer circuit  
35V 22uF

C2 = 0.01 uF  
For extra fast Hz  
use 0.001

1k resistor in series  
with 100k pot is  
optimal. Gives a  
guaranteed known  
minimum.

LED is for power  
indicator.

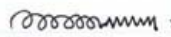
 = Entire symbol is Inductive Resistor 10Ω 100W

IRFP650 Mosfet = use only this Mosfet. If you use another,  
make sure it is "Repetitive Avalanche Rated"

Do NOT use Avalanche Proof Mosfet

8/1/09

COPYRIGHT 2009 - AARON MURAKAMI - ALL RIGHTS RESERVED

This is a big picture 8x11 inches so there is no mistaking the schematic and you can zoom in pretty good. This is the timer circuit I built right after the first timer circuit. The schematic is a circuit Peter came up with. I modified that picture of the schematic to reflect the actual values of components that I am using in the 555 circuit you see in my pics. I've used it over the course of the soap opera and am very happy with it since it does everything necessary. You can of course go to higher frequencies, etc and get a feel for the circuit.

The circuit has a max of 50% duty cycle. With the 100k pots, you can have pretty wide variability. I'm only using the lower 10% or so, but you can play with it on your own scopes to see the range you have.

As Peter said, it does 3.7% duty cycle at 2.4 kHz. **Make sure to use an inductive resistor**

with AS MUCH INDUCTANCE AS POSSIBLE for 10 OHMS. (Wire wound ceramic hollow core resistor).

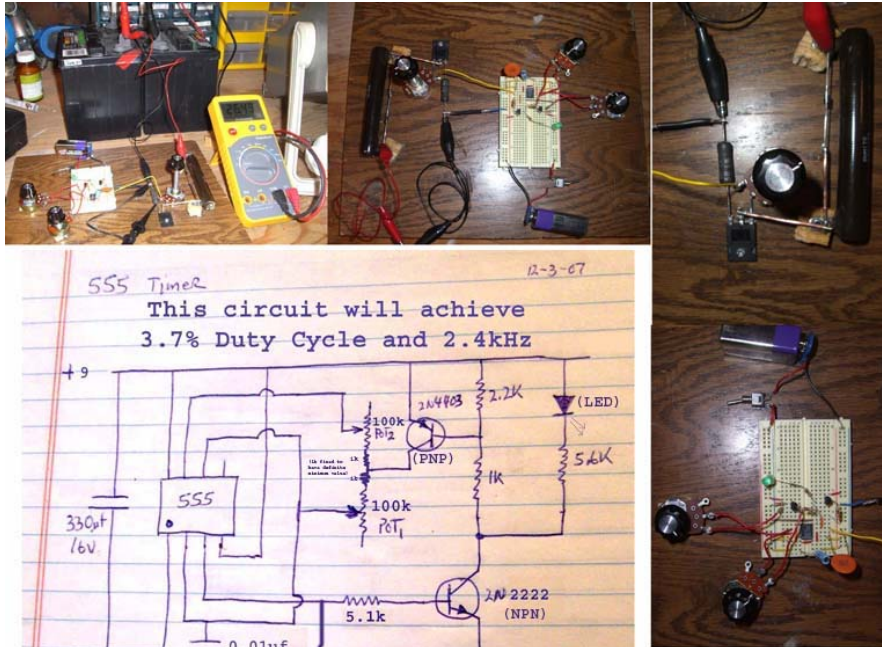

12-3-07

555 Timer

This circuit will achieve  
3.7% Duty Cycle and 2.4kHz

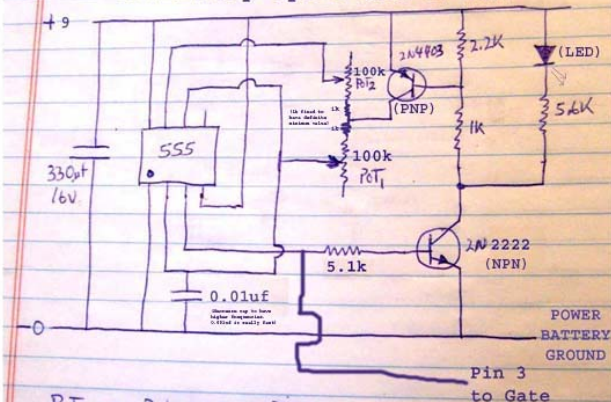

POWER BATTERY GROUND

Pin 3 to Gate

POT<sub>1</sub> = Pulse DURATION  
Less RESISTANCE = Higher Repetition Rate

POT<sub>2</sub> = Delay Between Pulses  
0 RESISTANCE = 50% Duty Cycle  
MORE RESISTANCE = Longer OFF cycle

This 555 timer circuit will give you the required 3.7% duty cycle and 2.4 kHz frequency to match Rosemary's test. You only need to use the bottom swing of the 100K pots. 10k may be fine.

### Aaron's Replication of Rosemary Ainslie's COP 17 Heater Circuit.

Copyright 2009 - Aaron Murakami - All Rights Reserved  
Distribute Freely as long as this image is unchanged.

IRFPG50 Mosfet - Do what you can to use this mosfet  
Ohmite L50J10R Inductive Resistor

The best resistor to use is the MAXIMUM INDUCTANCE you can get for 10 ohms for a wire wound resistor. Big with thick wire. Make sure it is hollow core and ceramic. My resistor is too small at this point. Shunt resistor is calibrated 0.05 use all short tight connections as possible.

You can use the scope across the shunt to tune the duty cycle and frequency.

Discussion Forum at [www.energeticforum.com](http://www.energeticforum.com)

Thread name  
COP 17 Heater | Rosemary Ainslie

[Download - 555 Timer Circuit for Rosemary Ainslie's Circuit](#)

### The control Test

I'm using one of Peter's power supplies to heat the resistor to determine the control wattage necessary at a continuous DC for a certain temperature. The below pic has notes telling what to do. Use this method to determine what volts and amps your steady direct current supply (100% duty cycle - constant on) is needed to get the resistor to be

at the temp that your Ainslie circuit runs at. Make sure both are at the same ambient temp for accuracy.

If your resistor gives you 175 degrees on the Ainslie circuit for your particular batteries when they're charged (use good condition batteries - no junk) and you're at your preferred duty cycle and frequency...and that temp stays pretty much the same when the battery shows you that it isn't going down anymore...use that temp as your gauge for the control. When resistor is cool, connect steady dc supply. If it gives you 175 when you are at 6 volts and 0.6 amps, then 3.6 watts is your control wattage.

(The 0.6 amps current leaving the supply shows the resistor is really 10 ohms right on the nose)

The resistance stays the same at ALL temperatures. They are designed for that so don't pay attention to misinformation that says otherwise. These are very tuned resistors specifically made to be at their rated resistance for a wide range of temperatures in the many hundreds of degrees. The resistance will be consistent and reliable for your calculations.

If you measure your power on your shunt during the Ainslie circuit test - do so only with True RMS meter that can store the data to give you a running total of the watt hours it used for that particular temp for so many hours. You don't have to run the control for as long as the Ainslie circuit. Once you know the temp when everything is equalized, take the power reading and it won't change over time.

The control shows that for 175F for 8 hours at 3.6 watts, that is 28.8 watt hours.  $3.6 \text{ watts} \times 1 \text{ hour} = 3.6 \text{ watt hours}$ .  $3.6 \text{ watt hours} \times 8 \text{ hours} = 28.8 \text{ watt hours}$ . If your Ainslie circuit gets to 175F and stays there for 8 hours but your true RMS watt hour reading is 28.7 watt hours. Then you just went over 1.0 COP. 28.8 watt hours is what is required and 28.7 is less. If you get 20 watt hours, then you beat it by more. If you get 10 watt hours true RMS reading, then you beat it by almost 3 times.etc...

This is the first basic test to do to replicate the findings of Rosemary Ainslie's tests. Once doing PLENTY of these over and over and over. Then, go to putting your resistor in whatever kind of calorimeter, etc... that you want. Do your tests with 0 resistance at the gate, increase resistance to remove the ringing and do the tests, get your mosfet in oscillation and do the tests. Change frequencies and duty cycles and see the relationship between them all.

How to determine your control - baseline test with the Rosemary Ainslie Circuit.

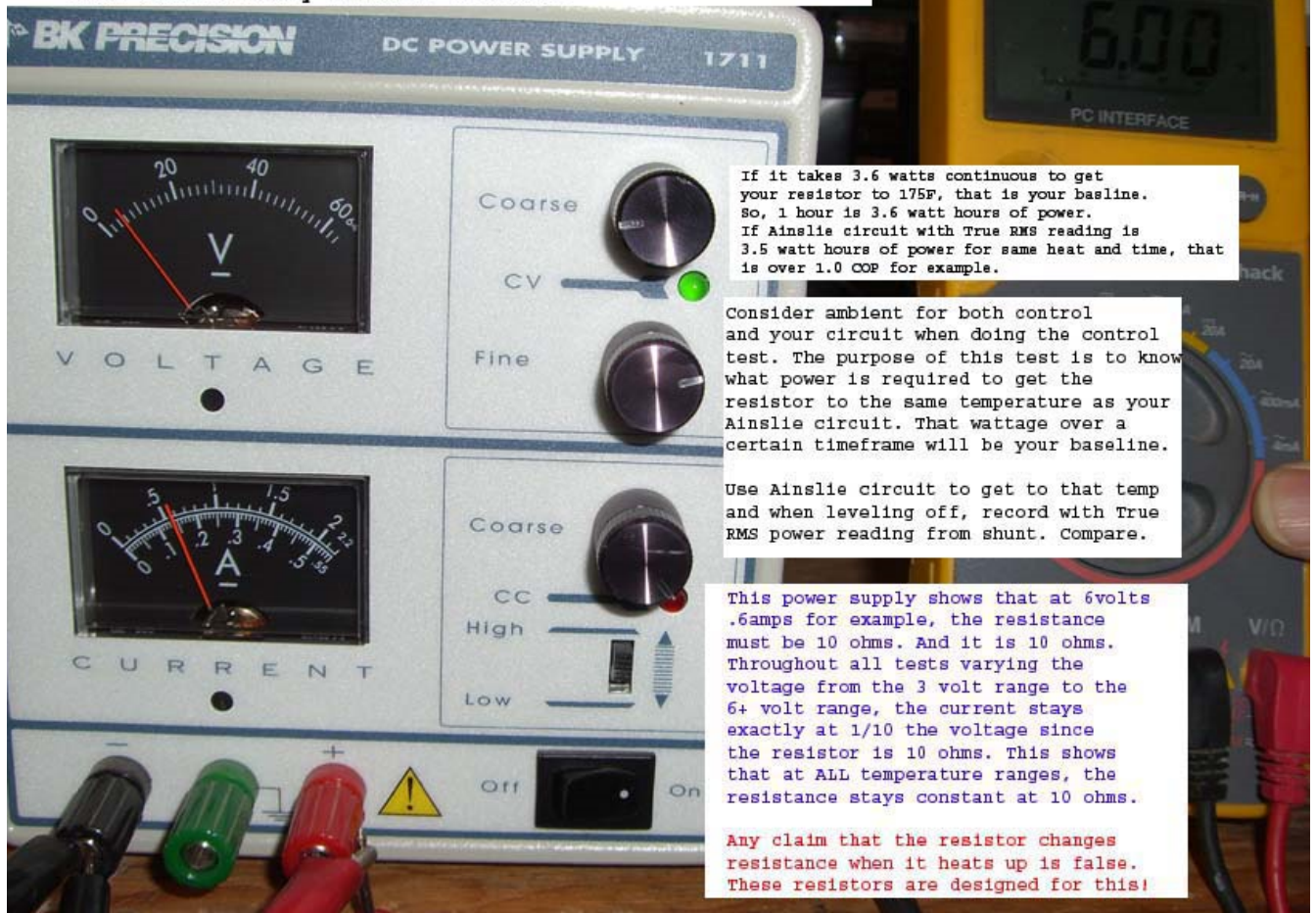

From Rossie -The watt hour rating of the batteries applies to values that, in turn require certain optimized amperage draw down rates. They never give those rates. You'll find that on a control regardless of the watt hour rating - say it runs for 10 hours to FLAAAAT - it will cost the test battery about 0.5 volts. It's way way more efficient. That's the only down side about batteries. You exceed the watt hour rating - but the watt hour rating is subject to battery vagaries. That's why - every time - the ideal is to get the measurement off the 'spike' value and for that you need good quality scope meters.

## Rosemary Ainslie Circuit Ringing Adjustment

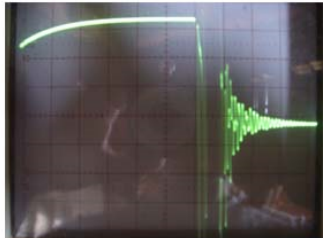

0 resistance at gate  
Chaotic ringing  
Less heat per power  
and less charging on  
power battery

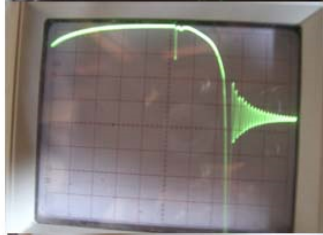

Little resistance at  
gate. Smooth ringing.  
More heat for less  
power and better  
battery charging.



High resistance at  
gate. No ringing.  
Soon to confirm heat  
and charging.

Any claim that the ringing cancels  
out the charge of the spike is  
complete disinformation. The spike  
charges the battery and the ringing  
after only cancels ITSELF out.  
It gives MORE heat and LESS power and  
a stronger spike to charge the batt.  
(That is the middle picture).

Discussion Forum  
[www.energeticforum.com](http://www.energeticforum.com)

Thread name  
Rosemary Ainslie | Cop 17 Heater

Copyright 2009 - Aaron Murkami - All Rights Reserved  
Distribute freely as long as this image is unaltered.

Quantum Article schematic By Aaron

Rosemary Anislie  
COP 17 Heater Circuit

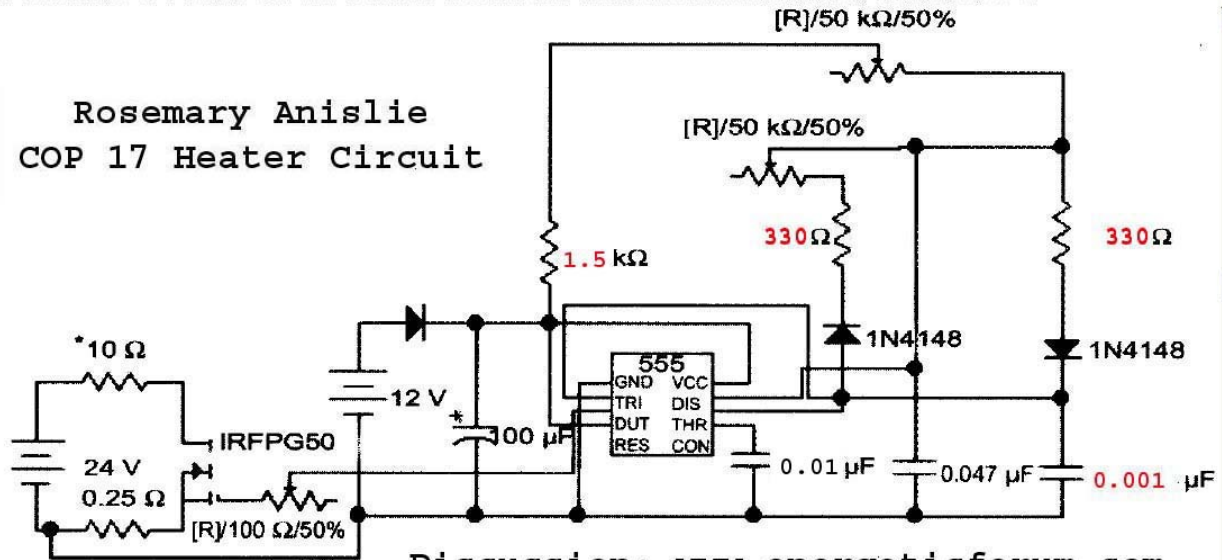

Discussion: [www.energeticforum.com](http://www.energeticforum.com)

Figure 1: Circuit diagram

Revised August 9, 2009

QUANTUM 5  
OCTOBER 2002

First Circuit By Peter/Aaron -NOTE: USE THE CIRCUIT FROM THE PAPER ON THE EXPERIMENT INSTEAD OF THE QUANTUM ARTICLE.

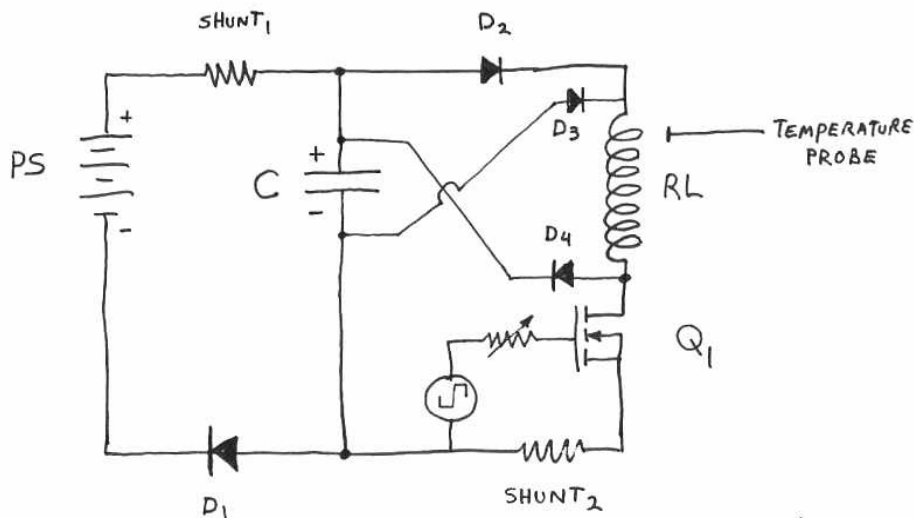

Circuit for the efficient production of Heat  
using an inductive resistor heating element and the  
recapture and recycling of the inductive collapse

Peter Lindemann  
2-15-09

Here is an explanation of the schematic diagram above which has been altruistically donated by Peter Lindemann. This schematic diagram is for the creation of an Electric Heater with a COP>20.

PS = the Power Supply. This is the Primary Supply of energy to the circuit. Any NEW ENERGY required to run the circuit must come from here. It can be a battery, or any source of DC current.

RL = the heating element (load) that has the electrical characteristics of both resistance and inductance. Electrically, the component is operated as an INDUCTOR to be charged and discharged in sequence.

C = a Capacitor of sufficient capacitance to act as a secondary power supply to power the circuit and to act as a reservoir to receive the energy returned by the inductive collapse of RL.

D1 = a Diode to make sure that energy can only move in one direction, in this case, FROM the power supply TO the capacitor. This component prevents any of the energy returning from the inductive collapse from travelling all the way back to the primary power supply. So, in operation, this Diode will allow the Capacitor C to rise to a voltage that is higher than PS, but it will never allow C to drop to a voltage below PS. SHUNT1 = a low value, calibrated resistor used to measure the currents leaving the Power Supply PS. Current pulses measured here, times the voltage of PS, represent ALL of the energy the circuit is "dissipating".

Q1 = a Power MOSFET, or any appropriate switching device to allow currents to magnetize the inductive load RL. This includes all of the timing circuitry for the circuit's proper function.

D2 = a Diode to complement Q1, to allow currents from C to energize the load RL.

D3 + D4 = Diodes to direct the energy of the inductive collapse of RL back to Capacitor C so this energy may be re-used. SHUNT2 = a low value, calibrated resistor used to measure the currents supplied from C (through Q1 and D2) to the load RL. Current pulses measured here, times the voltage of the Capacitor C, represent ALL of the energy supplied to the load RL.

**The circuit is designed to operate in the following manner.** Q1 is timed to produce current pulses which magnetize RL and then shut off, based on the inductive "current rise-time" of the component. The exact timing of this depends on the inductance of RL and the voltage of the Power Supply. RL then discharges as an inductor through Diodes D3 and D4 back to Capacitor C. This represents "one cycle" of the circuit. As soon as this cycle is completed, the process repeats.



**Edgewound Resistors**  
**0.064 to 3.57 ohms**  
**82 to 18 amperes**

RL is meant to be a Resistor Element made of NiChrome Wire, wrapped in a spiral shape around a ceramic frame, as pictured above. Every time there is both voltage and current present at RL, heat is produced. This includes both when currents are being supplied by Capacitor C and when currents are being returned to Capacitor C. Since the inductance of RL does not change during this charge and discharge cycle, the total amount of energy capable of being recovered from the inductive collapse should be on the order of 95% of the amount of energy supplied, during each cycle.

In this situation, currents can be supplied to RL and returned to C rapidly, with very little "real energy" lost to the circuit. Any energy that is actually dissipated, such as voltage drops on the switching devices (Q1, D2, D3, and D4), will be made up for by energy provided by the Primary Power Supply PS.

This "schematic" is provided without specific values, and is meant to provide a theoretical basis for understanding how an Electric Heater with a COP>20 could work.

## **Related and Experimental circuits**

### **Ainslie-Murakami Negative Dominant Waveform Generator**



**AINSLIE-MURAKAMI  
NEGATIVE DOMINANT  
WAVEFORM GENERATOR**

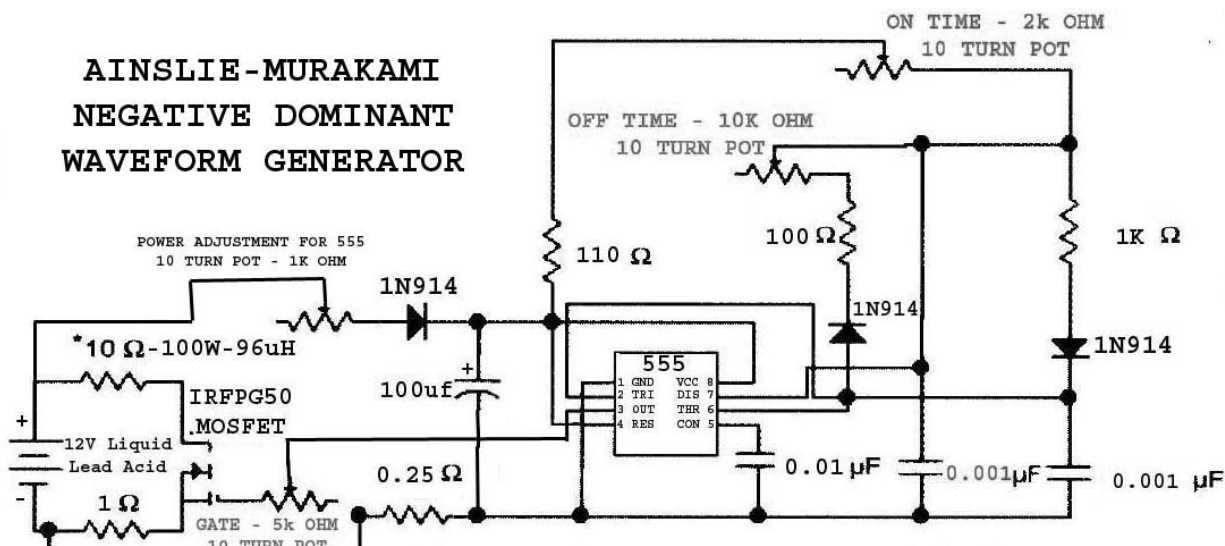

**Figure 1: Circuit diagram**

SCHEMATIC DATE: 2009-AUGUST-26

Original Circuit from: **QUANTUM** 5

COPYRIGHT 2009 - Aaron Murakami - All Rights Reserved - Distribute this freely as long as it is unchanged

OCTOBER 2002

[Ainslie-Murakami Negative Dominant Waveform Generator PDF](#)

[Detailed Integrated Power Analysis data - .csv](#)

[YouTube - Detailed Integrated Power Analysis of Ainslie Circuit](#)

The load has been up to 1.1C BELOW ambient with this circuit at these power levels - the doc says 0.8 below ambient. Please look at all above docs and videos thoroughly. The cooling effect has its own proportionate relationship to the negative wattage running through the coils. There have been many other tests done but this one is quite a slap in the face of conventional electron current theory. Load waveform (more below than above). Tek shot of waveforms of both shunts and battery - more below than above for shunts.

**Load**

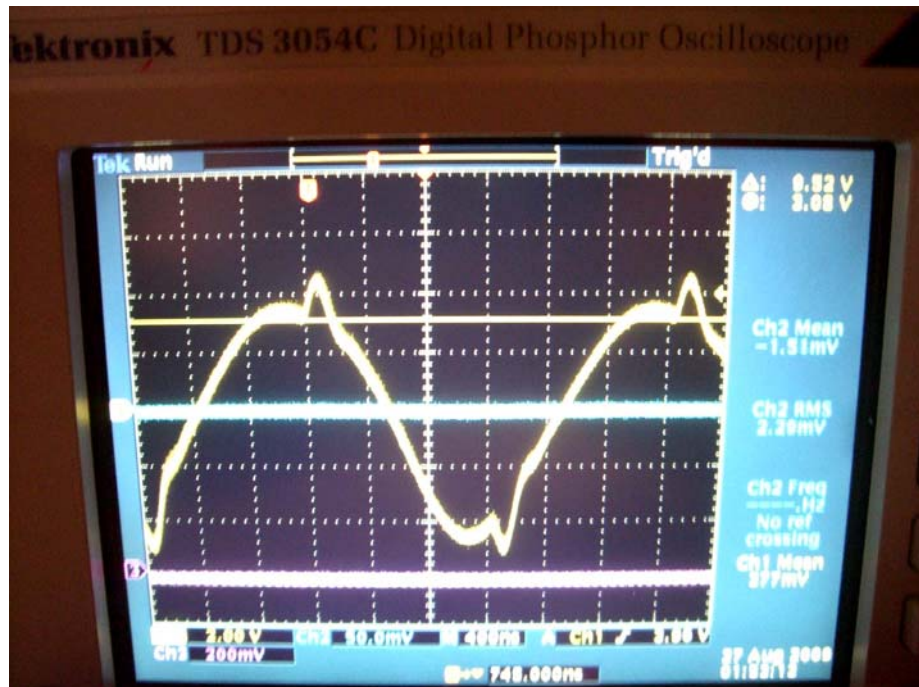

Wave

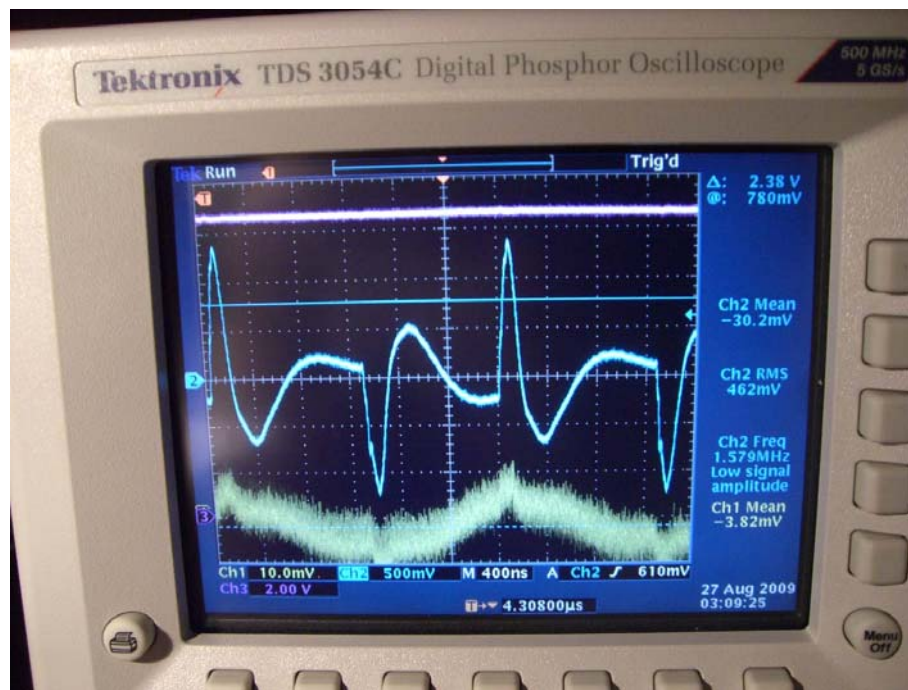

Rosemary Ainslie Circuit | Feedback to Timer Input By Aaron

Video: [YouTube - Rosemary Ainslie | Timer Battery Feedback](#). This is just for fun - to demonstrate that there is energy captured from the inductive resistor's magnetic field and it doesn't reduce the heat production or draw. Current induced to pickup coil, thru

full bridge, to cap. Cap is fed to front of timer circuit isolated so battery doesn't see it. 555 circuit runs on power in cap first and the battery only gives up the difference. Makes timer battery run longer.

This opens possibilities for optimum wound coils to capture even more without taking away from heat production. Perhaps the optimum pickup coil can supply the loss to a cap so the circuit self runs. I have not verified this. That is thinking out loud.

### Michael John Nunnerley circuit

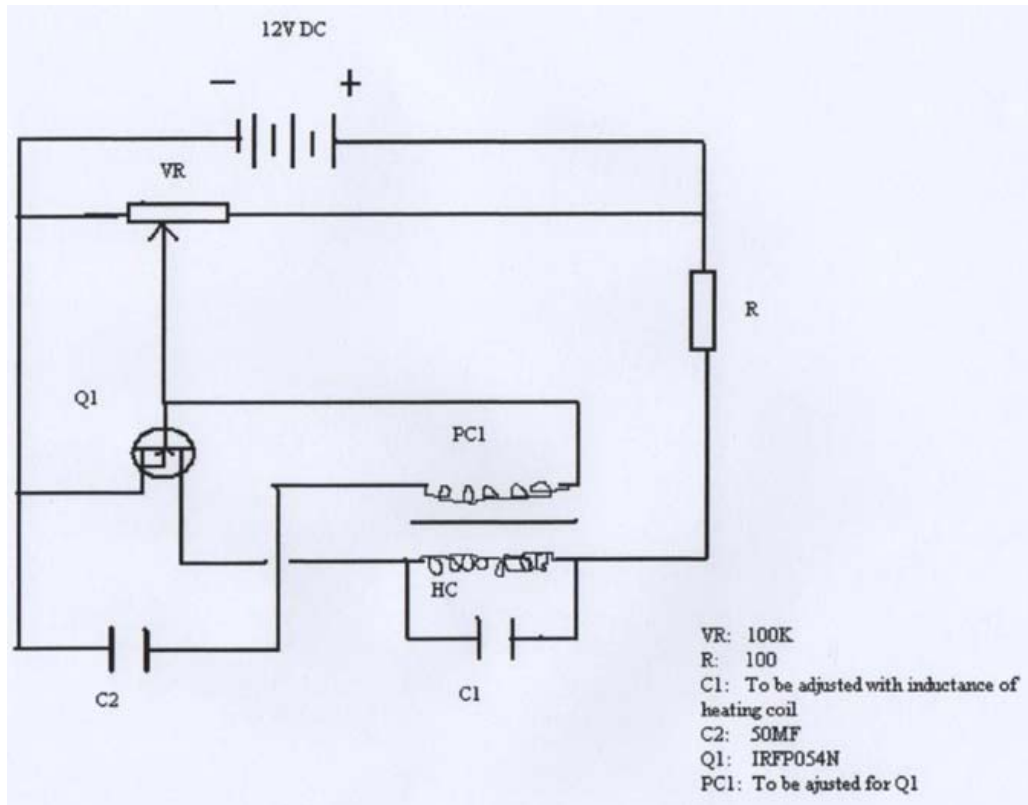

### **Circuit Not Tested**

Here is the circuit, which I think will need more work with experimenting. How it works is the heating coil and C1 is an LC circuit, the pickup coil controls the mosfet at the frequency of the oscillation of the LC circuit, VR is for the set point of the mosfet. Between VR and the positive rail should be a resistor of about 10K, which is not shown, to protect the mosfet. When the mosfet is off, C1 supplies the current, when on the battery supplies the current. There is no switching of polarity on the heating element coil, no diodes are needed. **THIS IS EXPERIMENTAL**

Comments from Peter Lindemann -Michael, Yes, your circuit idea should work. There is also the simplest version of the circuit, which is just the Inductive Heating Element in a tank circuit with a corresponding Capacitor, driven by a variable AC sine-wave Power

Supply at the natural frequency of the resonant tank. Also, if the components were large enough, the system could be tuned to run at 60hz. Then, there would be no local electronic components at all and the Heater Coil would simply run as an "idling" inductor with a local power factor correcting capacitor.

**Related -An electronic circuit to free energy - Thanks to FuzzyTomCat and NerzhDishual**

French Translation - [An electronic circuit to free energy](#)

Rossie's comments -I'm duplicating it because of its significance. The guy has been testing this 'reticulated' current principle and acknowledges it as 'zero point' energy. He's also a skilled experimentalist. PLEASE WADE THROUGH IT. He's been testing - in effect - our own principles and, I believe, a close approximation to GOTOLUC's experiment. Also significant is that he has found a simple way to prove it using one of those computer simulator programmers. But he looked far and wide to find one that was not modified to suit classical norms.

**An electronic circuit to free energy -Zoltan Szili**

For all correspondence here is the email address Zoltan Jean Szili-  
[p\\_baril@sympatico.ca](mailto:p_baril@sympatico.ca)

Introduction-"By publishing this very simple circuit, I would give fans the opportunity to prove that the extraction of electrical power vacuum exists. The purpose of my letter is to inform my work and help develop quantum generators for use by people and industries. I decided to make public a first circuit, and fans will be able to test it. "

Presentation of the author-"My name is John ZS All my life I worked in scientific research. For seven years I am retired. Thirteen years I lived in France. Five years in Lyon and Paris to eight years. In Paris, I worked at the University of Orsay in Physics of Plasmas. I was born in Hungary. I emigrated to Canada (Quebec) in 1969 and I found work at the Institut de Recherche d'Hydro Quebec in the field of scientific research. I stayed twenty-eight years until I retire.

One day at the restaurant of the institute, I sat at a table in front of two engineers and their invited experts processors. I listened to the conversation, and engineers have told their guest, they could calculate the parameters of transformers with an accuracy of 0.1%, but they are 2% of power still in too.

This surplus of power remains inexplicable while taking account of ohmic losses and so on. I left the restaurant thinking that this 2% of excess power could come from an unknown source.

A few years later I became aware of the theory of Zero Point Energy. I assumed that there should be a way to extract a part of this phenomenal energy. Since my retirement, I work hard to find circuits that could extract energy from the zero point. Quickly, I left out the laboratory work for the computer simulation, in order to expedite my work. I have tried thousands of channels before finding one and then several of these circuits that say in English "overunity".

Method of work-"When we explore an unknown field, one must use trial and error empirical. Gradually, we learn about this new unknown world of science and use this knowledge to find circuits more efficient. Currently, I know quite well how to extract the ZPE. The power of my circuits ranges from a few milliwatts to more than one hundred kilowatts. These circuits must be powered to operate, but the output circuits, gains power ( $COP = \text{energy output} / \text{energy input}$ ) may be very high. The gain or COP may be 2, 10, 100, 1000 and beyond.

In these simulations, I always used electronic components existing in the trade. This may facilitate the realization of these circuits in the laboratory. This work remains to be done. First, this circuit has been developed on a computer simulation. This allows for the simulation, the Jiles-Atherton model of electromagnetism. This model was designed to meet the reality test and not the law of conservation of energy. I cannot give guarantees regarding the functioning of this circuit, but until proven otherwise, have confidence in the simulation. This program is used across the world in electronic and physical laboratories. It is very close to reality, although in experimental 99.999% of 100 cases energy is conserved. "

The mechanism of extraction- "There are special conditions for there to be extracting energy from quantum vacuum fluctuations. The mechanism of extraction, in my opinion, is based on ferromagnetic resonance. The free electrons exchange energy with electrons virtual vacuum. Normally the exchange is completely symmetrical. Outcome: No energy extraction. In addition, electrons are fermions, and quantum mechanics, two electrons cannot be the same. The result is a dispersion very large in the frequency of ferromagnetic resonance, might be called semi-collective. This resonance is between a few hundred MHz and several GHz. Nevertheless, the circuits operate at a frequency less than one MHz. As against the circuit must be built as a circuit operating at least 25 MHz. Avoid loops, using more appropriate component. In these circuits, you must use special methods to make the asymmetric exchange of energy. In this case only, there will extract energy.

In publishing this first tour, my goal is to stimulate research ZPE. I think especially for amateurs.

A new about my research: I think I have found a physical law, connecting the electric

current in a coil (as used in the circuit is sent) and the inductance of the coil. This relationship seems to inductor current and fundamental in the extraction of electrical power. This relationship is reciprocal. A variation of current varies the inductance and inductance variation varies the current.

When electric current increases, it decreases the inductor, and a decrease in the inductance increases the current ... and so on. It is the effect of avalanche. The decrease of inductance has a certain limit determined by the electronic circuit. After stopping the avalanche, the process is reversed. The inductance increases and this lowers the power ... and so on. This return takes less time because there was no extraction of electric power vacuum during the return. Normally, because of electrical losses, the Avalanche will not begin without stimulation (eg a pulse above a certain value). The physical form of this relationship is as follows:

$I(L1) = (K1 / L(L1))$  - or  $I(K2(L1))$  is the current flowing through the coil and  $L(L1)$  is the inductance of the coil.  $K1$  and  $K2$  are two constants (unchanging) depending components of the circuit.

By adjusting the constants  $K1$  and  $K2$ , the curves of current and inductance are virtually identical. For other circuits, the formula could change, but what is important is that the current relationship and the inverse of the inductance should remain valid. "

"This circuit is very simple in appearance, but to successfully make it work, then you need to take drastic precautions. True, it operates at a relatively low frequency of 20 kHz. As against, the signal generator pulse must be a square, positive, with a rise time of 10 nanoseconds from 0 volts to +5 volts. The simulation shows very clearly that if the rise time of the square is longer than 10 nanoseconds, the extraction decreases very quickly and completely canceled between 50 and 100 nanoseconds.

The simulation also shows that a parasitic capacitance at the point of connection of the transistor (M1), the inductor (L1) and output resistance (R1) with a value of 100 picofarads to ground, completely destroyed the extraction (capacity of 100 picofarads may be the ability of an oscilloscope probe). The parasitic inductances can also prevent the extraction, if it exceeds 10 micro Henry. In assembling the circuit, we must minimize the loops, as if the circuit were fonctionner to 25 Mhz. In fact, the element is the extraction of the ferrite toroid inductor (L1). "

Schematic and measures- [Not need an oscilloscope to demonstrate on the unit: it is enough to measure currents ex 2: between the earth and the resistance R2, and between the land and the resistance R1 "](#)

# ZPE OVERUNITY DEMONSTRATION CIRCUIT

by Zoltan Szili

e-mail: p\_baril@sympatico.ca

Time Step = 10 nsec

  
 K1  
 Ferrite toroid  
 TX20/10/7-3E5  
 Ferroxcube  
 Area = 0.336 square cm  
 Path = 4.36 cm

Rise Time = 10 nsec  
 square  
 25us +5V, 25us 0V  
 20 kHz

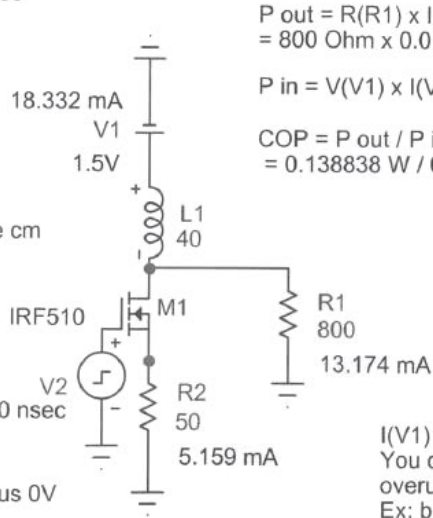

$$P_{out} = R(R1) \times I(R1) \times I(R1) = 800 \text{ Ohm} \times 0.013174\text{A} \times 0.013174\text{A} = 0.138838 \text{ W}$$

$$P_{in} = V(V1) \times I(V1) = 1.5\text{V} \times 0.018332\text{A} = 0.027498 \text{ W}$$

$$COP = P_{out} / P_{in} = 0.138838 \text{ W} / 0.027498 \text{ W} = 5.049$$

OVERUNITY = 504.9 %

$I(V1) = I(R1) + I(R2)$   
 You don't need an oscilloscope to prove overunity, only measuring two currents.  
 Ex: between ground and resistor R2, and between ground and resistor R1.

2004-12-19-ODC1

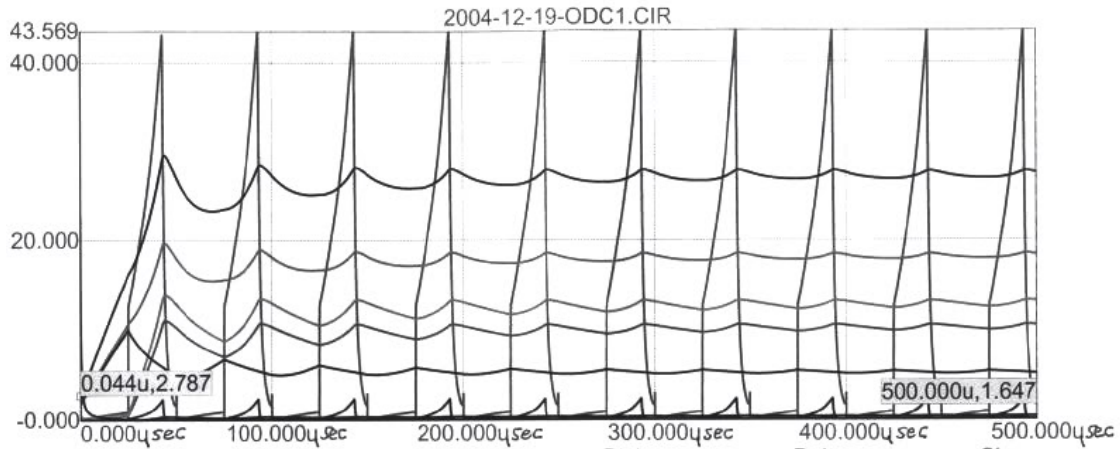

	Left	Right	Delta	Slope
V(R1)	2.787	1.647	-1.140	-2.280E03
AVG(V(R1))	2.390	<u>10.539 V</u>	8.149	1.630E04
0	0.000	0.000	0.000	0.000E00
I(R1)	0.003	0.002	-0.001	-2.850E00
1000*AVG(I(R1))	2.987	<u>13.174 mA</u>	10.186	2.037E04
1000*AVG(-I(V1))	1.738	<u>18.332 mA</u>	16.594	3.319E04
I(R2)	0.017	-1.194E-05	-0.017	-3.433E01
1000*AVG(I(R2))	13.357	<u>5.159 mA</u>	-8.198	-1.640E04
V(R1)*I(R1)	0.010	0.003	-0.006	-1.264E01
AVG(V(R1)*I(R1))	0.007	0.350	0.343	6.861E02
-V(V1)*I(V1)	0.003	0.003	0.000	9.832E-01
1000*AVG(-V(V1)*I(V1))	2.607	<u>27.498 mW</u>	24.892	4.979E04
1000*AVG(-V(V2)*I(V2))	44.604	0.039	-44.565	-8.914E04
T	0.044µ	500.000µ	499.956µ	1.000E00

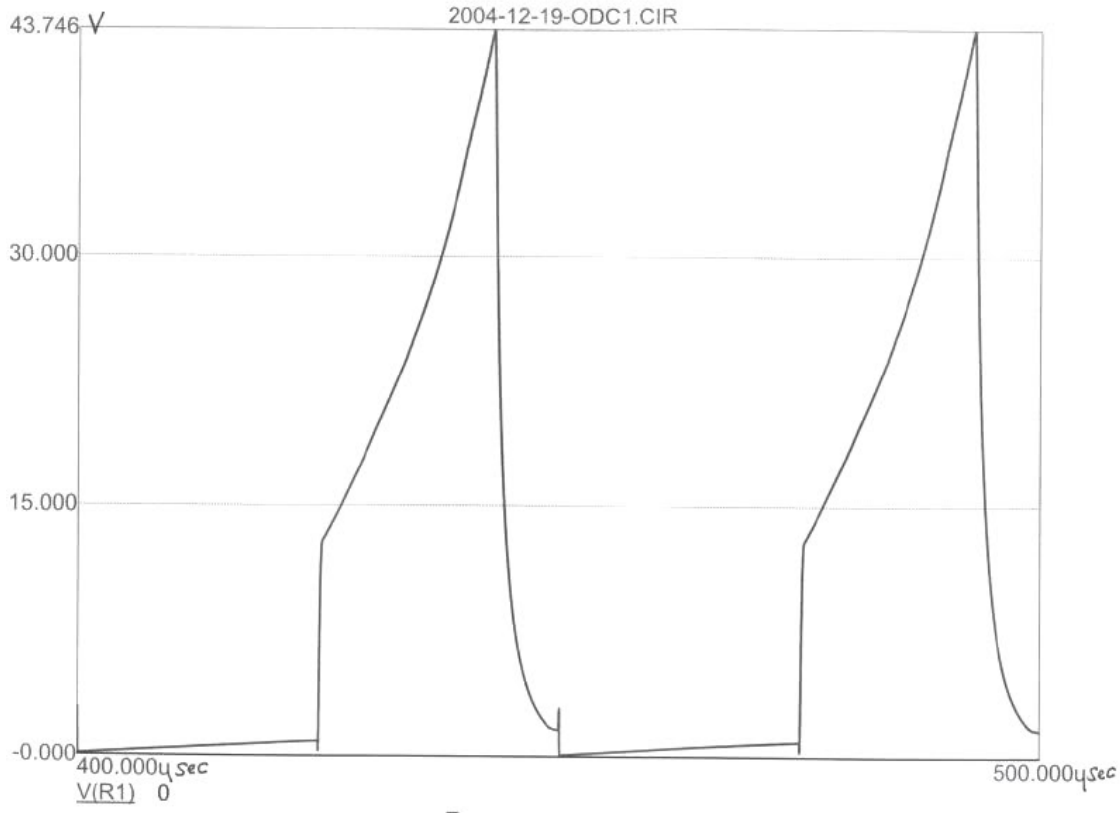

T



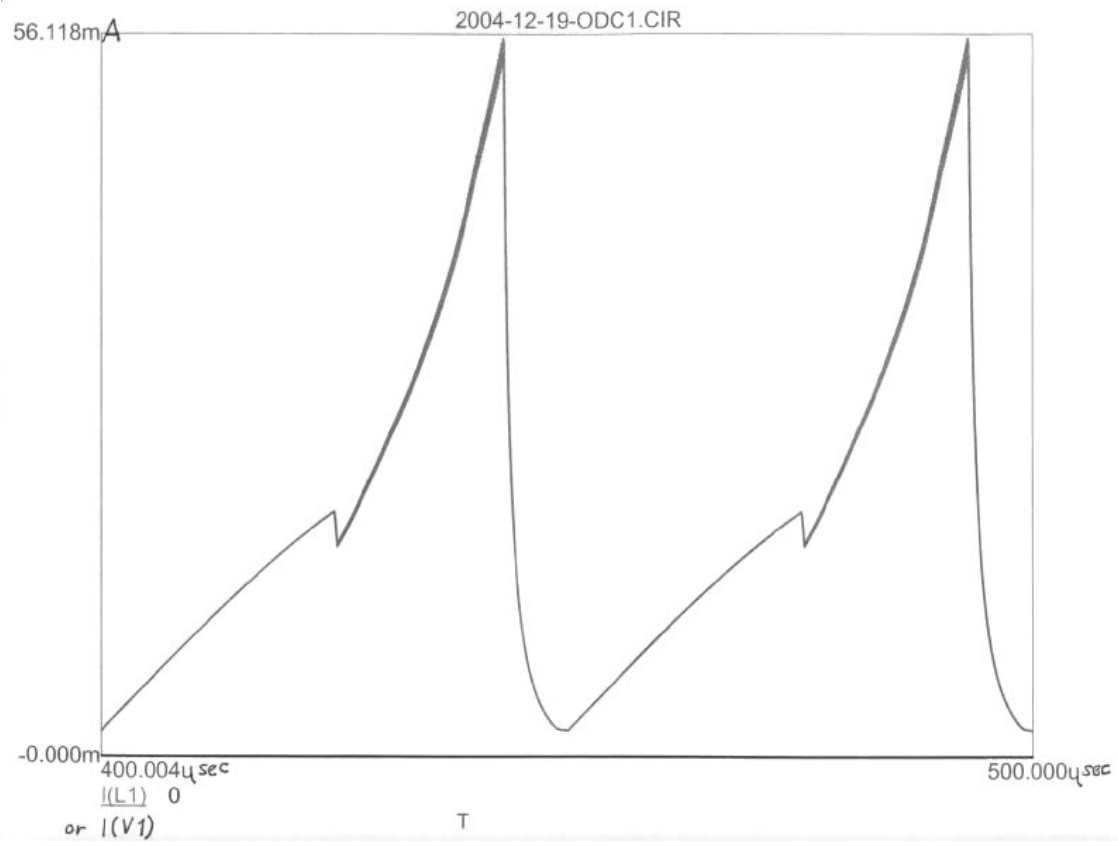

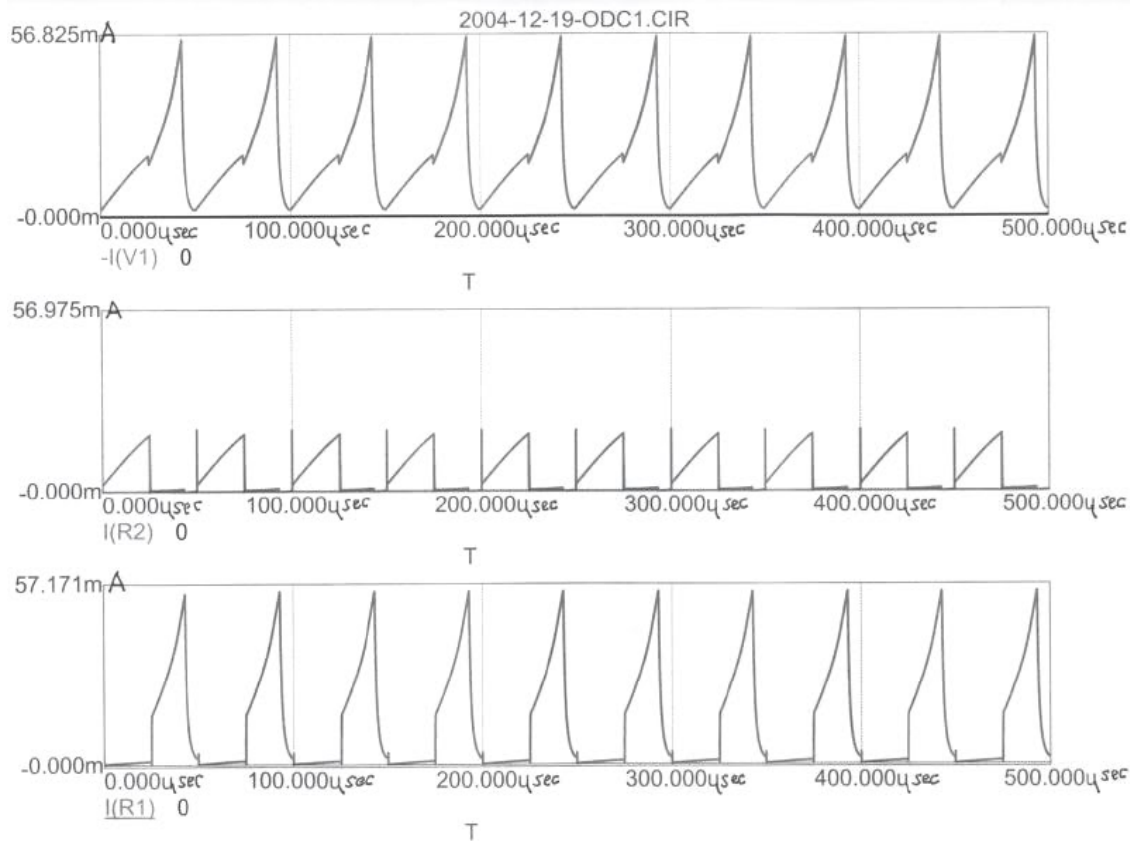

### **Related articles to this circuit**

[Jean Szili -- Zero Point Energy extraction circuit](#)  
[An Electronic Circuit to Free Energy](#)

[Rosemary Ainslie | A Magnetic Field Model](#) – Energetic forum

### **Faculty information**

#### **Understanding energy by Rosemary**

In order to prove the claim I also need to refer to the model's definition of current. But this would hardly be appropriate without some reference to known definitions of current flow. If I may I'm starting with a definition of current flow as per wiki's definition. It's so full of holes its laughable. I'll then follow up with a more classically accepted definition. All I'm trying to point to is that current flow may not, in fact be the flow of electrons. At this stage I'm not referring to an alternative. If the tenor of this post is offensive then let me apologies in advance. But there is a real need to show those points that classical physics has not, in fact, addressed.

'Wiki definition of current flow requires 'free floating electrons'. Given that these electrons that come from - somewhere? - also somehow 'attach' to a wire or any such conductive circuit components then can someone please explain this scenario. Take your average lead acid battery as a DC power supply. If these electrons 'travel' where do they go once they've reached the opposite terminal? Through the battery courtesy the 'pump action provided by the battery?

Now Wiki explains that batteries, fortunately, have 'free floating protons'. This gets ever more interesting. Where do these 'free floating protons come from? Then. The electrons presumably need to travel through the battery. Presumably also they do this by attaching to the protons, somehow? But, if the electrons attach to the protons during their journey through the battery - then we get simple hydrogen atoms. The battery would then, theoretically, become a repository of pure hydrogen or subtle variations of this, each state - deuterium - tritium - becoming progressively more explosive than the last.

If the quantum of electrons on the wire or in the circuitry, exceeds the number of free floating protons - then we have a problem with that 'cluster' of electrons that cannot get past the terminal.

If by some happy accident the number of 'free floating' electrons precisely equals the number of 'free floating' protons then 'attachment' would result not in a reduction in potential difference but in an increase. This is because hydrogen - apart from being highly combustible in any condition

- is also a negatively ionised atom. Therefore one would think that the increased ionisation would also result in an increase in the potential difference measured across the battery. It would not result in a decrease. What then accounts for the decrease is the actual measured result of current flow?

If, on the other hand - given that these innate logical contradictions were somehow answered by some force not yet incorporated in conventional explanations of current flow - but yet requires the flow of electrons - then the speed at which the electrons again 'detach' from the structure of those protons - would in no way equal the rate at which current is measured to flow through circuitry.

Then, assuming that the potential difference is reduced, notwithstanding the increase to potential difference courtesy the ionised state of these hydrogen atoms, and over time the battery indeed becomes flat - we recharge it - how? By adding more 'free floating electrons' or 'free floating protons / or possibly both?

So I put it to you that the 'flow of electrons' is logically inconsistent with the known properties of current flow. Here's the thing. The 'flow of electrons' was proposed as an enabling image - never a fact. That it then became incorporated into classical

definition as 'a fact' is a sad reflection on the reluctance of scientists to grapple with contradictory evidence. Rather do they just accept all such explanations, the more obtuse the explanation, the more likely it is to be accepted. It hearkens to the story of the king's invisible cloak. At some point someone must point out the obvious.'

Guys, I copied this from a thread that I started on the Naked Scientist Forum under 'a circuit that produces overunity' - I think it's titled. In the event that any of you want to look it up it's posted under the name Witsend. In any event, this is relevant to point at questions that relate to energy - on a broader basis than the wiki definition. I promise you I won't need to refer to current flow after this except to suggest that it is - in fact - magnetic fields, as proposed in the paper that I submitted to the IET.

"I cannot understand the existing model because it makes no sense. Let me point out a little known truth. Nobody knows what energy is. It is known to be sourced from four forces, some say three. These are gravity, the strong and weak nuclear force and the electromagnetic force. Some people ascribe the weak nuclear force to the electromagnetic force. The miracle of our physicists is that, notwithstanding this lack of knowledge, they are able to use and apply their knowledge of these forces with breathtaking and impeccable accuracy. That is the truly amazing.

But notwithstanding this no-one actually knows what energy is. The fact that current flow is ascribed to the flow of electrons is still a question that is actually also still out there. If it flows as a current - like a stream of something - then it flatly contradicts Pauli's exclusion principle. And Dyson emphatically states that it is not the flow of electrons. So does Gary Zukov in his book - the dancing wu li masters. If it is not a 'flow' but rather the interaction of 'clouds' of valence electrons with sundry ions in various structures and amalgams, then what is added to a battery when it's flat and needs to be recharged? It can't be electrons because electrons are widely considered to be stable particles, and not able to decay.

So whatever property is re-introduced to the battery during the recharge process, cannot be more electrons else your average battery would eventually be chockablock full of a surplus of electrons. Nor are electrons simply able to change their charge or indeed any of their properties.

However, there is a possibility that one electron can decay into two photons in certain unstable atoms. And therefore it can be argued that electrons decay at the various work stations as photons. This is because photons are known and measured to be dissipated at resistive loads. This would be consistent with measured evidence. But an extension of this argument then requires that your average generator would need to also generate an inexhaustible supply of spare electrons in order to account for the amount of heat dissipated at your average household and the vast number of such houses connected to your average supply grid. This is somewhat unlikely. And even if

this were managed, the question remains. Where do these spare electrons come from? And so it goes.

Wiki explanation of current flow is so full of holes it's almost comical. Whatever comprises a current flow is definitely not consistent with classical theories of this. What I am daring to point to is that the entire field of quantum electromagnetic dynamics is not entirely consistent. That it is the single most extraordinary field of Endeavour with - among all branches of physics - the most consistent and effective reach in its applications - does not also put it beyond the reach of further questioning and analysis. Yet there are those in the field of physics and engineering who are offended at any questions applied to its fundamentals. They say it is a complete theory. "

For the record. The question at the heart of my modest experiment goes to a simple known law in physics - the well known inductive laws. You will notice that all OU claims are related to switching circuits that generate a second cycle of back electromotive or counter electromotive force, back to the system. The argument for the classicist has always been that this energy is first delivered by the supply and then stored. The switch is closed. The stored energy then gets used. The result therefore is zero extra being introduced.

The 'new age' physics claims that the energy is delivered from the source. It generates an extruded magnetic field throughout the circuit components. When the switch is closed, these stored fields re-generate a second cycle of energy that is then used in the system. The only way to prove this conclusively is to apply all tests to an independent supply source. The most reliable is a battery supply source as there is no need for any contact to any extraneous grid supply which then confuses the argument.

But to actually test how much was delivered and how much was returned needs an analysis of the 'spike' or the returning energy - evident in all such cycles. The measurement apparatus intended, or has been or is being used, whichever is appropriate - will ignore what is returned and what is delivered and will show an equal amount of energy on both the input and output of the circuit. So I am asking, in advance, that you discount any such results. And I would ask Jibbguy, if you wouldn't mind, to please address this question, again, on that forum. They will be obliged to respect your knowledge on this matter as it is incontestable. As the matter is of some considerable importance I would be glad if you could help us out. -Rosemary

### **Relation to Steorn by Harvey**

For those that may be interested, Steorn has its live feed up and running ATM. [Steorn - Convenient, Clean and Constant supply of Energy](#) It is their claim that the prototypes will continue to run indefinitely as they are generating about 300% more power than they are consuming. Both of these systems (Rosmary's circuit and Steorns Drive circuit)

use sharp edge magnetic pulses in their operation. Both Rosemary and Sean have alluded to the possibility that their energy is linked to dark matter or dark energy. Both of these systems have produced a documented COP > 3. Both of these systems have excess heat in addition to the documented work load. It is quite possible that both systems have their gains rooted in the same power source.

I have been doing some thought experiments surrounding Rosemary's model and have discussed some of the geometry with others superficially. We may have to accept that the shapes of these particles are not strictly spherical. We may also have to accept the possibility that there is a gender relationship responsible for part of the interconnections between them. In other words, and interlock can occur between particles that is dependent solely on shape which is reinforced by a weaker gravitational and electromagnetic attraction. These things become necessary where the 2D surface is of a specific area normal to a sphere but the volume for which is bounds is less than that of a sphere due to surface impinges. I have been performing these experiments based on my own concepts which are taken from Einsteins work surrounding curved space and gravitation. In simple terms it is a displacement theory. The gravity of any single particle is proportional to the volume of space that its surface displaces. Therefore, if you have a sphere with six impingements on 3 axis which take on the catenary form along each axis, you would have a particle with the same surface area (and thus the same energy / mass relationship) as the sphere, but the spatial displacement is considerably less. This gender specific (female) particle could then interlock easily on any of the six sides with an inversion particle (male) which would resemble a six pointed 'jack'. Likewise, hermaphroditic particles could exist as well, all of which could easily provide interlock systems and polarities that can interpose electromagnetism and gravity. The foundation of any particle rests on its energy content. If its energy is not stored as matter, electromagnetic or kinetic then it must be stored as thermal energy. The concept that a particle itself, apart from any other particle, can contain a thermal register has been proposed and set aside by academia. This may have been presumptuous. While it is well known that temperature is directly related to kinetic energy in atomic material assemblies and the molecules they frame up, little discussion exists regarding the actual material that quantum particles consist of and whether or not that material itself can contain thermal energy. When we evaluate this in our thought experiments we uncover the possibility that thermal energy can be stored in the 2D surface of these particles of which protons and electrons are made. One of the simplest examples of this may be HHO gas. If the evidence indicates that more heat is being produced in the metals being heated by an HHO flame than can be accounted for in the production of the HHO itself, then we must ponder if the proton and electrons themselves have stored thermal energy that is able to be communicated to the metals (or any other material for that matter) electromagnetically during the flame proximity interaction.

This point is a vital point as part of Rosemary's magnetic model. In her writings you will find reference to Zipons becoming slow and big and hot. For those versed in thermodynamics this simply fires up the alarm systems because classically it is the small, fast energetic particles that produce the 'heat' in thermodynamic reactions. But we must allow our minds to consider a large, slow moving particle such as a hydrogen proton, that has a high thermal register. And we must consider that if this existed, how would the thermal energy ever escape from it? It is at that point that we begin to realize that it must be converted to another form or else it is trapped there. If two protons were able to touch, then perhaps a transference could occur, but this is neither practical nor necessary. Magnetic fields have a means of sweeping these particles and providing conduits for this energy to find balance where most material common to us is at an average of 300°K.

Thus in Rosemary's model, all energy is communicated via electromagnetic interaction and from her perspective even the 'electro' portion of that is only a convenient method of looking at the same thing from a different perspective. If a zipon in superluminal space contains a finite portion of energy and part of that energy is stored in its velocities, mass and temperature, then it follows that if the velocity is reduced then that portion of the energy must be converted to temperature and mass.

Naturally the question of relativity arises and it was explained to me that the velocity is always an angular velocity. This is a new concept as well because it intimates that light only travels in great arcs and never in a truly straight line. And that arc identifies as its center, the center of a minor radius of a toroid which constitutes our universe. The tighter the arc, the closer you are to the center of the universal minor radius. There is also a motion along the axis swept by the revolution of the minor radius around the major radius. So technically, a photon moves along a spiral path through the toroid. Don't worry if none of this makes sense to you now. In time it will. It is sufficient that you have read it so that your thoughts can digest it slowly. When these things become fully understood, replicators like those on the sci-fi Enterprise will become as common-place as microwave ovens.

### **Confirmation of principles**

Luc's- [YouTube - Effect of Recirculating BEMF to Coil test 3](#)

Rosie -FANTASTIC WORK. Please EVERYONE who reads this thread. PLEASE CHECK THIS OUT. Two videos - both showing the effect of 'reticulated'? Energy. It is incontestable proof and with all the experimental evidence on view. Gotoluc I cannot tell you how deeply grateful I am for this. Tears to the eyes. I am blown away. It's my test - but configured differently so that it explains the effect so much better than I have ever done. It is the very first test that has ever been made entirely public - to prove the very

real benefit in a switching circuit using collapsing magnetic fields. It is a day I will always remember. Thank you very, very much.

Luc - Since my pulse circuit is basically using the same 555 timer that you are using and Groundloop was very limited in time he sent me the link to the circuit he has posted before.

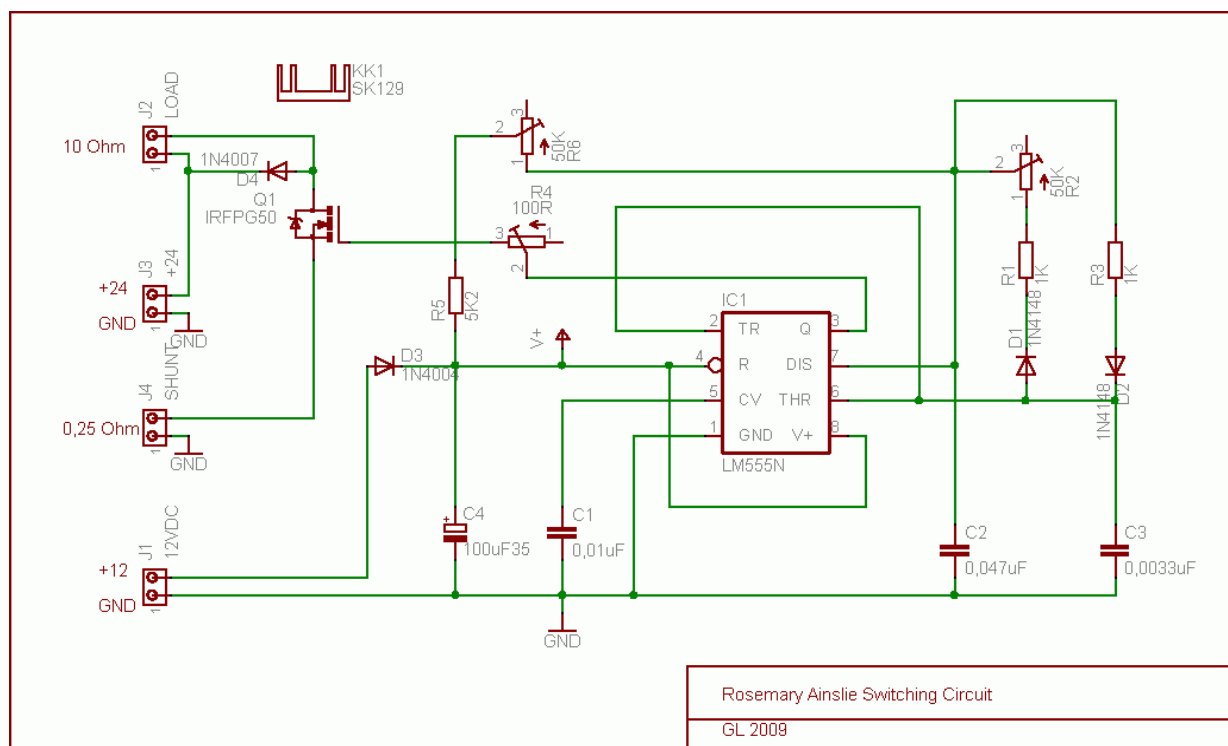

The only difference in my circuit is I'm using an IRF840 as switching mosfet and the capacitor used to set the frequency around 665 Hz is .001uf. I also used a 1Meg pot (for duty cycle) since I had it on hand and found it to have smoother adjustment at 10% or lower duty cycles.

My coil is 800 feet long or 244 meters of #20 AWG or .81mm magnet wire wound on a spool used for mig wire welding equipment that has an 1-1/4" or 32mm opening in the center, a total of 4" or 100mm in spool diameter and a width of about 1-1/2 or 38mm of open area to wind the wire between each ends of the spool. The coil has a DC Resistance of 8.3 Ohms and Inductance of 63.5mH. This coil is the best performing @ 665Hz of all my 10 or so coils available for testing.

The recirculation diodes are two MUR420 in parallel soldered to the negative side of the coil and directed so positive can flow back to the positive side of the coil when the collapsing field occurs. I have a switch between the positive sides of the diode and coil in order to observe the effect of not recirculating the collapsing field. My power supply



is 120vac through a FWBR to a 400v 330uf capacitor. Nothing more I can think of.

If someone has the ability to make a complete illustrative kind of circuit (non EE style) of all the above information it would help beginners or non EE trained to replicate this also. Thanks for your interest in this simple circuit. -Luc

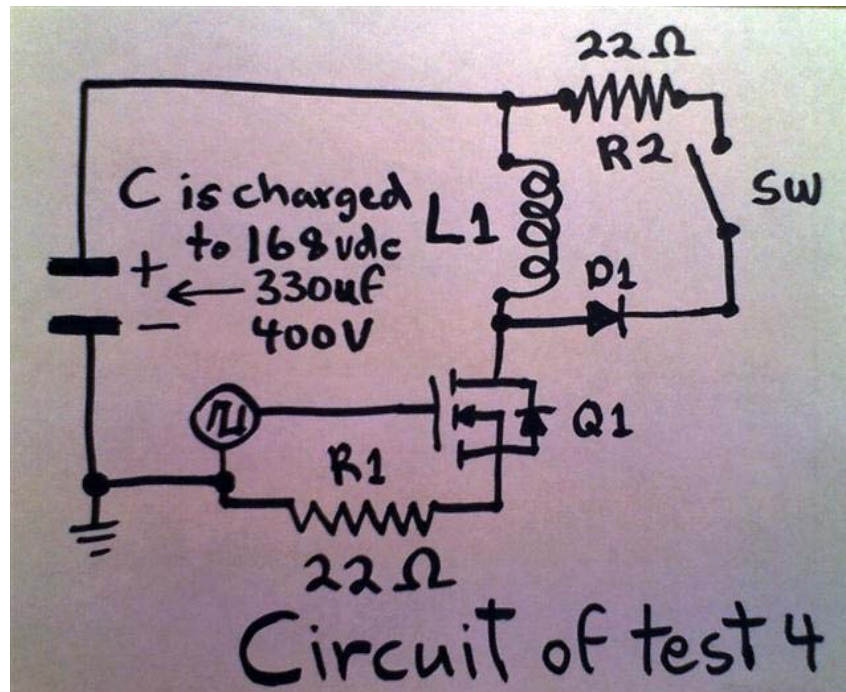

[Download Luc's Flyback paper by poynt 99](#)

**From Jetijs**

You should look at Peters electric motor secrets thread: [Electric Motor Secrets](#). I made a simplified schematic so that it is easier to understand:

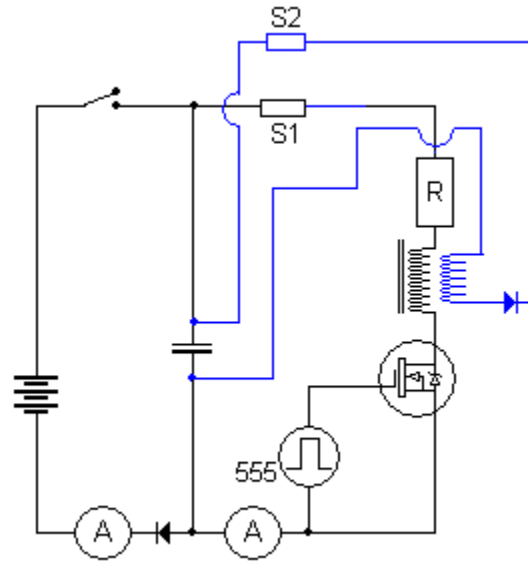

We just use a bifilar coil. One winding is the power winding and other is the recovery winding. It takes some time for the coil to develop a magnetic field around it. As the field builds up, so does also the current that is flowing through. When the magnetic field is at its max strength, current does not rise anymore and goes in a flat line. Here you can see how this looks like on a scope across a shunt resistor:

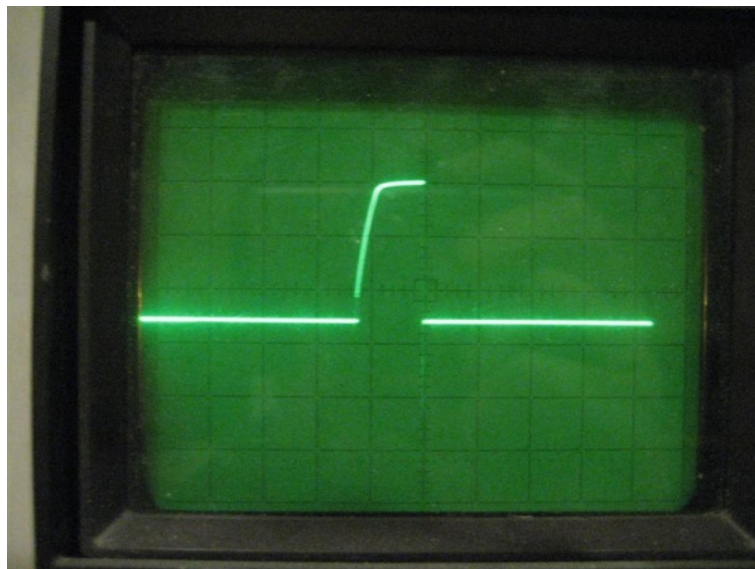

You can see that the current rises till the coil core (if there is any) is fully magnetized, after that the current does not increase anymore. There is no need to maintain the current flow any further because this is just power wasted and we cannot recover it. So we adjust the duty cycle so that the ON time is only short enough for the coil core to

fully magnetize. So now we have a fully charged coil. If we now cut the current flow then the field collapses and induces a new current that we can recover and send to the front side capacitor. There will be losses, but we can recover up to 90% of that energy and maybe even more. The cap charges up and thus less power is needed from the power supply. This is what the current waveform looks like across the S1 shunt resistor:

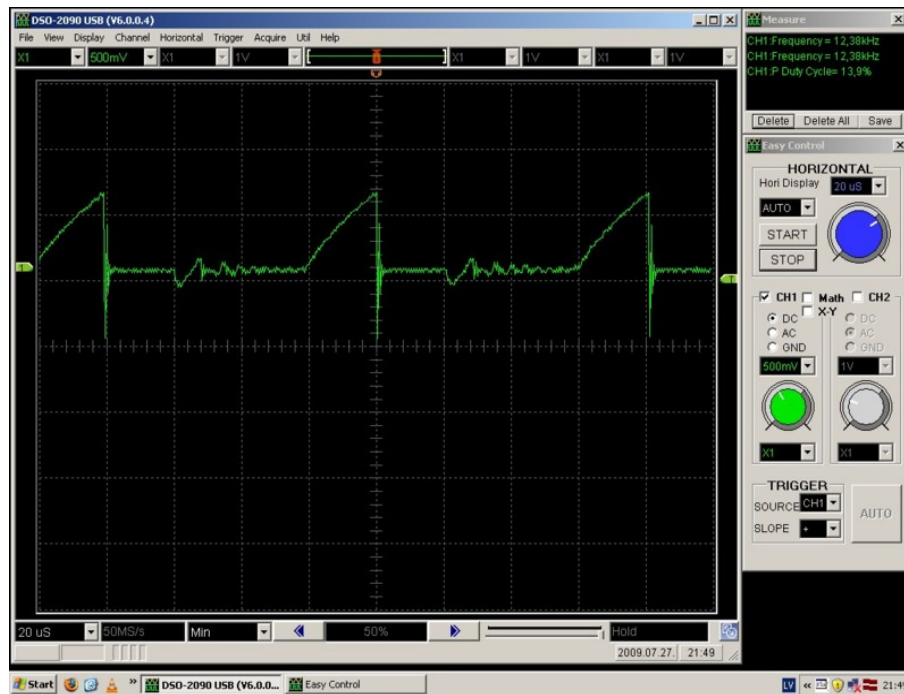

And this is the current waveform on the S2 shunt:



So you see that we can get most of the energy back and this is real current flow that indeed can charge up a capacitor. So all we need is just to adjust the duty cycle so that the on time is just enough for the coil core to fully magnetize and this will get us the best input/output ratio.

Hope this helps

## Measuring

From Rossie-There's another point. We actually ran our tests with a control. The reason the published article and the paper deal with a test period of 10. Something hours is because that is how long it takes the control battery to deplete its energy. For some reason, both in the quantum article and the paper I was specifically advised that any reference to battery duration was essentially irrelevant. Apparently battery draw down rates are subject to too many vagaries?

In any event, the actual draw down rate of the tested batteries is consistent with the energy measured to be delivered by the battery as the difference between the energy measured and calculated from the two cycles of each waveform being above and below zero. At the end of that test period the test batteries are more or less the same as at the start of the test period. The control is entirely flat.

We then recharged both battery sets (always used typical 12 volt car batteries) and swapped the control with the test. Variations of this was called for by BP to enable their accreditation of the tests. It was exhaustive and painfully repetitive.

Regarding batteries - I need to clear this point up. I cannot comment on whether there is a 'real' charge value in that returning energy. I can only say this. The battery appears to discharge at a rate that is consistent with the wattage measured across the shunt. Also, our batteries outlast the controls showing that there's evident efficiency.

But - whatever the charge, real, imagined, measured, fluff whatever, the point is this. If the measurements, all by themselves, indicate a gain, then, theoretically, whether the supply is from the supply grid or from batteries, the fact is that the gain is measured according to classical protocol.

This is hugely significant. Every acknowledgement also puts paid to electric energy being constrained by the second law. It also means that potentially we can return energy from the house to a general power grid, simply by applying that circuit to household appliances. BUT to get there we need acknowledgement from academics that we are doing this. They cannot refute the evidence on a battery. Therefore why can our utility supplier not discount returning energy?

I'll tell you why. They've got a good argument. We may only need a fraction of their voltage - but we need the full value applied to extract that fraction. It's their real cost related to sustaining a continual supply at the required voltage level. But the amount of energy required will also be systematically reduced. SO. In my view - the only intelligent way of applying this energy, God willing that it ever gets that far, and subject to some combination of this and bedini motors or even something better than this and yet to come to the market - is that it should be possible to run the household supply from the grid. But - again subject to accreditation of these principles - it should also be possible to return some of this excess to a general grid.

Then, there can be no argument from the utility supply source. And maybe they'll also open their watt meters to allow this returning energy. Apparently, at the moment this is not enabled. Certainly not here is SA. That way the cost of applying our own electric energy supply sources is offset by the cost to the grid for returning energy. Imagine it. All those houses making energy and returning surplus to a national grid. It's got to be a help.

But the first and most important point is to prove that the battery is being recharged. The quickest proof is through the fly back diode to the battery. When there's a broad general consensus on this proof then we should be able to persuade our academics to acknowledge the principle. But, in turn, that's also the difficult part. They won't want to acknowledge it - for just so many other reasons. We've got a fight on our hands. But it's probably worth the effort. And if we fail the argument - it is very evident that progress will not be halted.

We always ran our tests on 4 or 2 batteries - depending on the dissipation required. 4 means 2 x 24 volts tests. 2 means 1 x 12 volt tests. Both tests always run in conjunction with each other - ie control and experiment. When the test period is completed both batteries swapped - test to control and vice versa. Both battery sets recharged and the same test repeated. That's on EVERY test. And each test had precisely the same battery types so we could compare apples with apples.

Hope that makes it clearer. The battery draw down rate - or amperage from the supply appears to be consistent with the sum of the voltage across the shunt \* vbatt.

*During this time of first gaining academic acceptance, with no offense at all to Rosemary, i would suggest the entire focus be on verifying EMPIRICAL results, with little or no mention of the Theory behind it: We will be more successful with the above IMO if we only attempt to foment one revolution at a time Jibbguy*

Just to point out here - we've done this. Over and over and over. Everyone looks at the results - shakes their heads - and then moves on with their lives. Look at the list of accreditors. One even went so far as to offer our local university a bursary to take the study further. The professors in their wisdom saw fit to challenge that there was any point in the exercise. And I haven't even covered the full list of accreditors in that paper. Lots and lots and lots of electrical engineers of varying caliber - and qualification - saw or replicated that experiment. It still sat dusty and ignored for 7 years.

In point of fact unless this is a stated object that the academics look at the argument and not the evidence only - we may as well be shut up shop right now. It really is not enough to cross fingers and hope that academics will be impressed. They won't. They don't even come to demonstrations. The paper was not even sent to review. Substandard or not I should have had a reviewer's recommendations for resubmission. I am most anxious that the 'spike' be evaluated on a theoretical basis. Obviously the demo will support this. And if we don't point out the significance who will?

That's why I'm so anxious to point out that the results cannot be explained in terms of stored energy. They must be seen as a regenerated cycle of energy during the off period. Everytime I get close to this (sorry was interrupted) point then the subject veers away. It's in the face of a vast number of boffins who've bought into the 'stored' theory and explained it with some really exotic science.

I am so frightened that this will again be evident and ignored. That's all that I've found so far.

What I'm actually saying that I don't think there's a shortcut to finding the answers without some precision equipment. What's actually needed is a way to measure the

'shunt' values (on our circuit) with a dump of all the voltage values across a few sample waveforms. That way you'll get an immediate means to 'sum' those voltages and work out the actual wattage dissipated by the battery. It doesn't take too many samples to find the optimum frequency - with or without that oscillating frequency. In any event, I hope this helps. Obviously it all depends on where you live - whether such a shop has the required equipment - and whether they'll give you access.

My own experience, as mentioned, is that most people are intrigued with the experiment itself. So you satisfy your need for experimental numbers and their curiosity - both. Hope that helps. Just as a word of encouragement - I think that you are all probably looking at gains already. I'll try and explain it. For those that have already 'got it' apologies for the repetition.

You need to get a scope that is able to distinguish between two values. The one is the difference between the voltage values over the shunt. It requires a DC coupling. Here the voltage that results from the counter electromotive force is deducted from the voltage that was applied by the battery. That's the sum of the energy from the battery. But you will see that the wattage dissipated at the load is consistent with both values. So there you have to add those two values. The difference between these two numbers is the gain. You'll find that it's very easy to prove this. The tricky part may be in getting access to the scope. But - as mentioned above - try phoning precision or any engineering shops. They've usually got the required and you'll be surprised how accommodating they can be. It all helps to 'spread the word' - while you're at it. Anyway. I'm sorry it needs this leg for proof - but I see no way around it unless you simply compare battery draw down rates with a control. It's tedious - but still very evident.

Therefore - in my view - it will be an impossibly difficult task to argue the benefit in stored energy on this particular circuit. I first thought you were using that fly back diode directly to the cap. But I now need to point out the actual point of conflict between 'us' and the classicist. In this example we are arguing that we only need a drawdown of 8% of the energy supplied to give back four times greater efficiency. That argument is quashed on many levels but possibly the strongest being that the utility supplier will also argue that while we may only need 8% of the applied voltage he gives us - he cannot thereby reduce that supply to 8%. He's got to keep it at a constant level. In other words he is expected to apply the full 120 volts over that entire duty cycle period and he'd prefer to be paid for whatever it does cost to generate that potential difference at 120 volts as opposed to  $120 \times 8\% = 9.6$  volts. So we lose out there as well.

I would be really interested to see results on the fly back being returned to the cap, as I first presumed. However, I would like to refer back to my own circuit. Before I do this, I must also point out that Peter has given you guys a variation on my circuit using a cap in parallel to the load resistor. It was proposed as a more efficient system. I do not know

as I've never tested it. But one of my colleagues has. He reported an extraordinary 10 minutes where the cap ran the system with a disconnected battery. But he was never able to repeat that result. And he is now, unfortunately in Durban - some distance away. And I understand his work demands are such that he is not able to spend as much time on the circuit. The point being that if we are going to see that magical closed system then Peter is spot on. It will be with the use of that cap and some really fine tuning to get it right. Such takes time and dedication.

In the meanwhile - let me try and explain the only benefit of my circuit to the general cause is that it delivers over unity results that can be measured strictly in terms of classical analysis. In other words we do not need to get into that endless circuitous?? Argument that loops? Back on itself without a definitive conclusion.

We only use a resistor. Therefore if the battery has 'stored' extra energy on that load - then it can be measured. And better yet, if there is any energy generated during the Off period by the resistor - then that energy can be returned to the battery. Unlike our utility supplier - we can now definitively and accurately measure the gains versus the losses to determine a result that even our classicists cannot argue with. In fact they've told us how to measure it. BUT the measure of that returned energy - while conforming to classical requirement - also needs some reasonably sophisticated storage oscilloscopes to PROVE the returning energy. The sum of the energy measured over both the On and Off period of the duty cycle ALWAYS (within certain frequency parameters) is less than the product of both cycles. The product relates to the energy dissipated at the load. The sum or difference between the two cycles relates to the energy delivered by the battery supply source.

Then I have much more to say about this system as it relates to an application to a utility supply source but that can be the subject of another post. I think this is enough to go on with.

The claim to achieve any over unity result is really contentious. That it will generate anger from the both readers and contributors must therefore be inevitable. It is based on deeply held convictions from both sides of the argument. I know this.

I think therefore, any argument that is based on some question of science be it measurement or logic, should therefore be enabled, if not encouraged. But, this is only provided always that it is not accompanied by any indulgence in personal insults. The point is this. I and others on the forum do not hide behind an identity. Any comments that can be construed as an attack on the character or ability of those of us who do not hide behind an identity is, therefore potentially actionable. No-one would tolerate that level of insult outside of the forum. Why then should it be tolerated within the forum.



Freedom of speech, while a desirable object, also carries with it the need to temper that expression. I know I am largely speaking to the converted here. But it seems that yet there is a need to remind people. As has been repeatedly said by many contributors - courtesy is always a good guideline. Quite apart from which the lack of this tends to kill the energy that makes these forums 'just such a nice place to be', in the words of Armagdn03.

**Glen's AKA FuzzyTomCat - Negative Dominant Waveform Generator replication**

**Tektronix TDS 3054C Testing - Part #1**

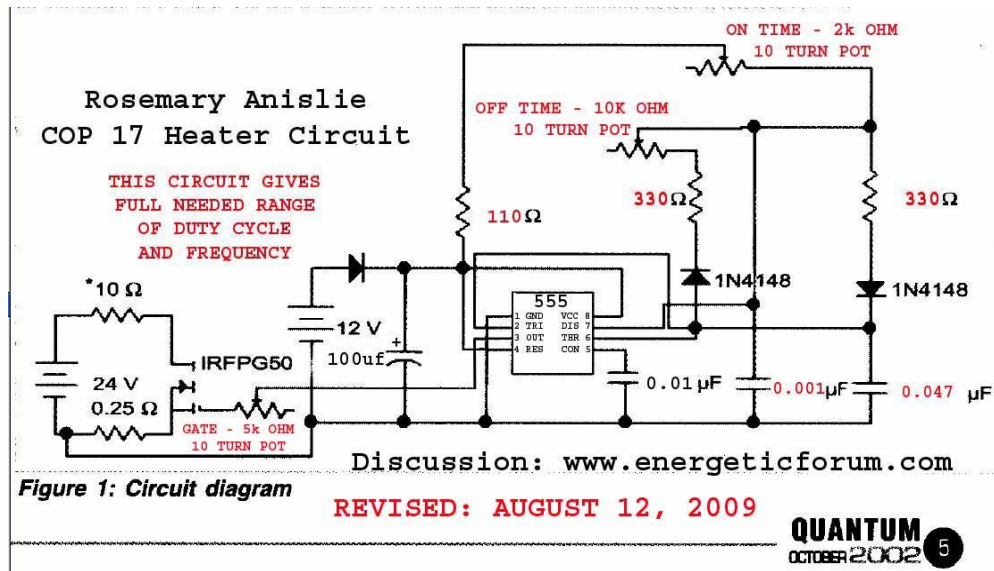

As some of you may be aware that I have a working replication of the [Anislie - Murakami Negative Dominant Waveform Generator](#) circuit and have already shown my earlier results in [POST #2606](#) and indicated that my Tektronix 2445A 150Mhz Oscilloscope was just not able to make the fine adjustments and record any data that could further this replication.

I contacted Aaron and was allowed to travel to his home some 550 miles away to use the Tektronix [TDS 3054C](#) that was on loan to Energetic Forum and presently in Aaron's possession. This was kind of funny because I live not more than 15 miles from Tektronix's Complex and Corporate offices in Wilsonville & Beaverton, Oregon.

I cannot thank Aaron enough for his help and hospitality also Lisa from Tektronix for the opportunity to use one of the finest pieces of equipment I have had to view it's operation and use ..... basically my Tektronix 2445A I was 50% blind on what was happening in the replicated circuit and without any quality recording capability.

## Negative Dominant Waveform Generator replication TEST #1

Replication Components - ( Items #1 through #4 used in both TESTS #1 and #2 )

- 1) [International Rectifier - IRFPG50 HEXFET® Power MOSFET](#)  
w/ Sil-Pad insulator between Mosfet and Heat Sink
- 2) [Fairchild Semiconductor - NE555N Timer](#)
- 3) [Vishay Spectrol - SP534 Percision Potentiometer/ 10-turn 2-Watt](#)
- 4) [Exide Technologies Battery "Liquid" Model # GT-H - TRACTOR 12V 12Ah CCA 235](#)
- 5) Original Test Load Resister "Clarostat" 10 ohm + - 5%, 225 watt, 64.7 uH ( never before used on my replicated circuit )

Photos - 50 mV Div, 2us - SORRY for the poor HD photos it was 12:00 am after traveling hours and hours it didn't happen a second time





Data sheets below test # 2

### **Negative Dominant Waveform Generator replication TEST #2**

Tektronix TDS 3054C Testing - Part #2 Here is the second test, as noted in the previous Test #1 components items #1 through #4 are the same.

#### **Components -**

- 1) International Rectifier - IRFPG50 HEXFET® Power MOSFET
- 2) Fairchild Semiconductor - NE555N Timer
- 3) Vishay Spectrol - SP534 Percision Potentiometer/ 10-turn 2-Watt
- 4) Exide Technologies Battery "Liquid" Model # GT-H - TRACTOR 12V 12Ah CCA 235
- 5) [Quantum 10 Ohm + - 1% "Replication"](#)
- 6) "ADDED" 4,000 ohm resister in series between 555 power adjustment potentiometer and 1N914 diode positive rail

#### **Potentiometer Adjustments -**

- 1) Gate- .5 ohms
- 2) On- 201.6 ohms
- 3) Off- 317.3 ohms
- 4) 555 Timer- 688.0 ohms ( "plus" 4,000 ohm resister "Total" = 4,688.0 ohms )

#### **Temperatures - ( constant + - .5 F )**

- 1) Mosfet- 76 degrees F
- 2) 555- 76 degrees F

- 3) 10 ohm Load resistor- 76 degrees F
- 4) Desk Top- 76.5 degrees F

**Battery Voltage** - 12.45 VDC ( Fluke 87 ) **Additional Oscilloscope** -Monitoring the 10 ohm "Load Resistor " [Fluke 123 ScopeMeter](#)

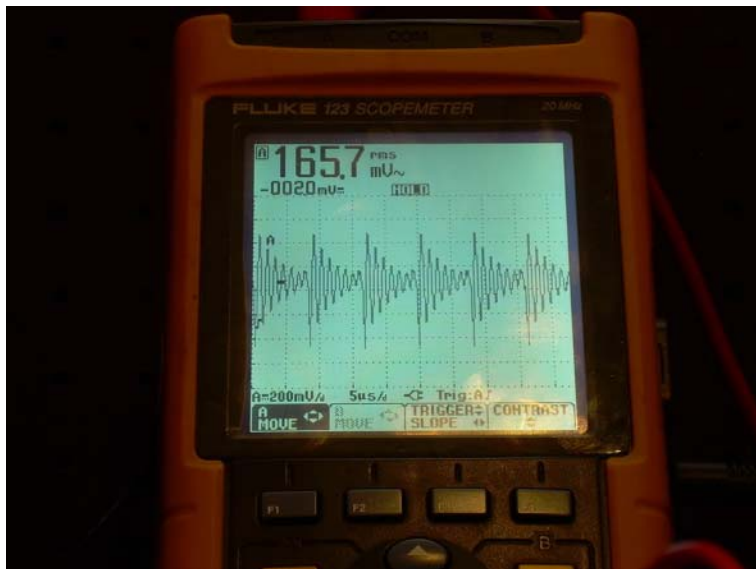
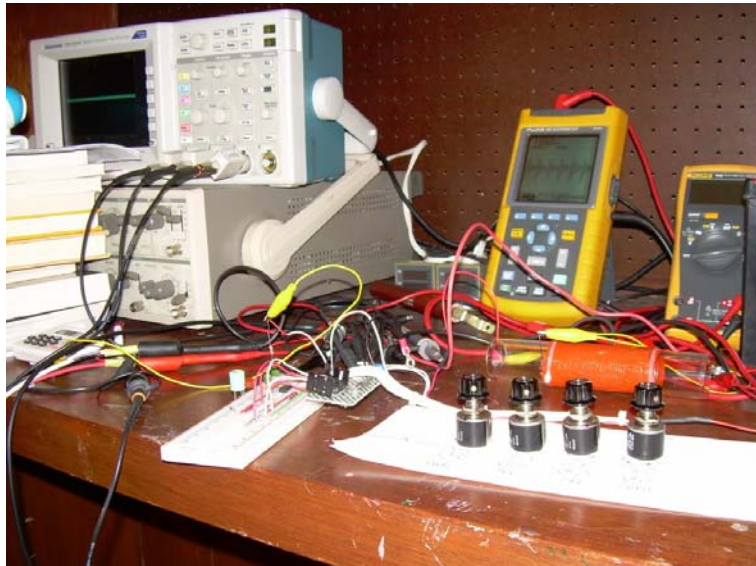

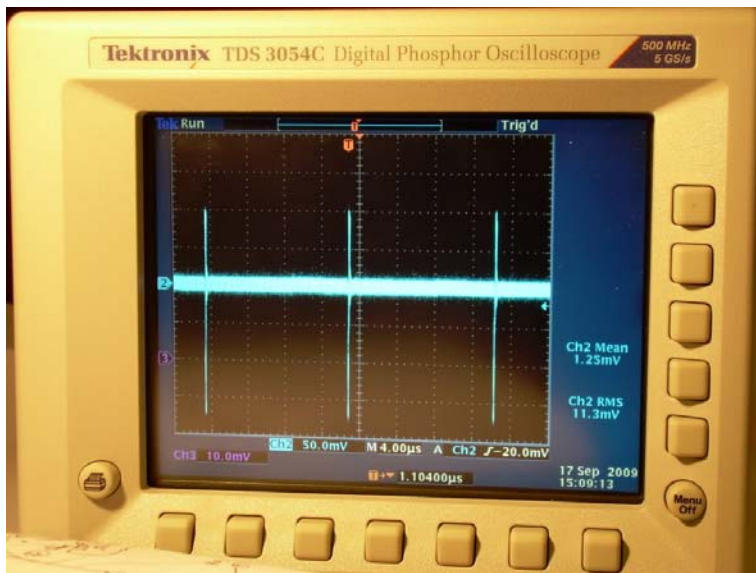
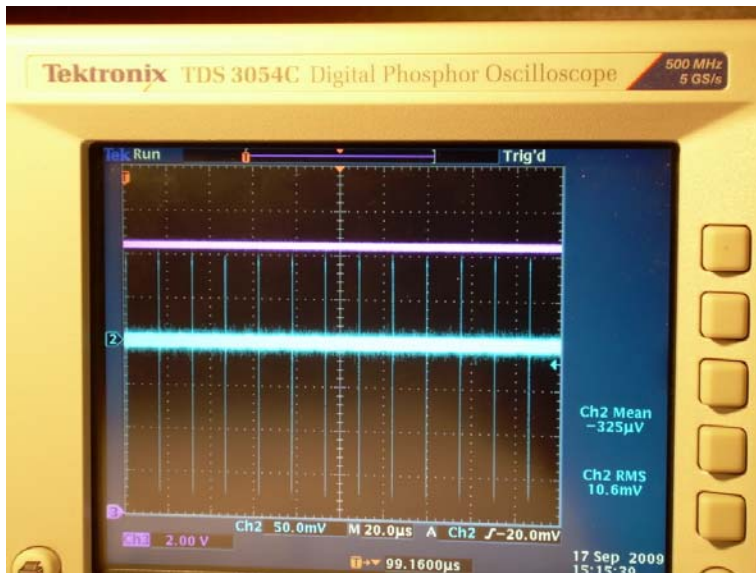

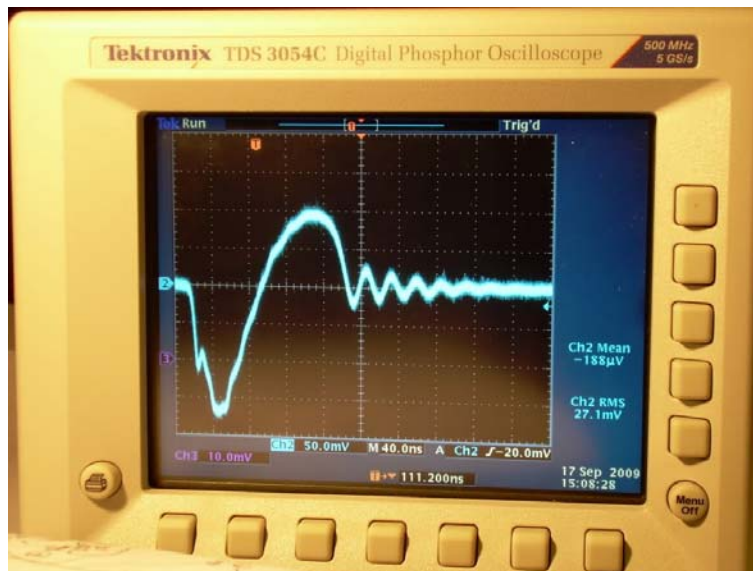
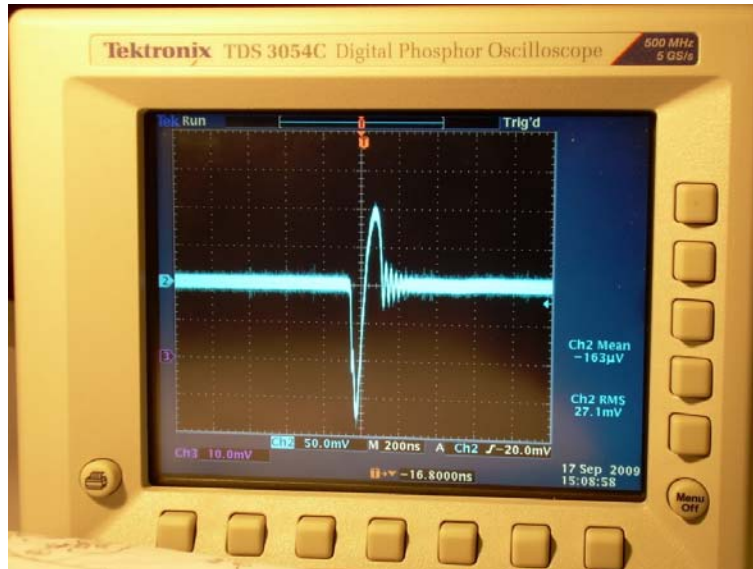

[Negative Dominant Waveform Generator replication data for Test # 1 and 2](#)

### **First Dominant Waveform Generator replication**

Here are some more scope shots of a periodic oscillation wave forms using a "Frequency Counter" on the Battery (+) and (-) connections, the "Ainslie-Murakami Negative Dominant Waveform Generator" replication is running around 1.2 Mhz

**Channel 1** ground is on battery negative side of 0.24 ohm shunt and probe is at 555 negative rail side of shunt. A1 trigger @ 34mV, 50 mV, Probe at X10

**Channel 2** ground is on battery negative side of 0.25 ohm shunt and probe is at mosfet source side of shunt. 20mV, Probe at X10

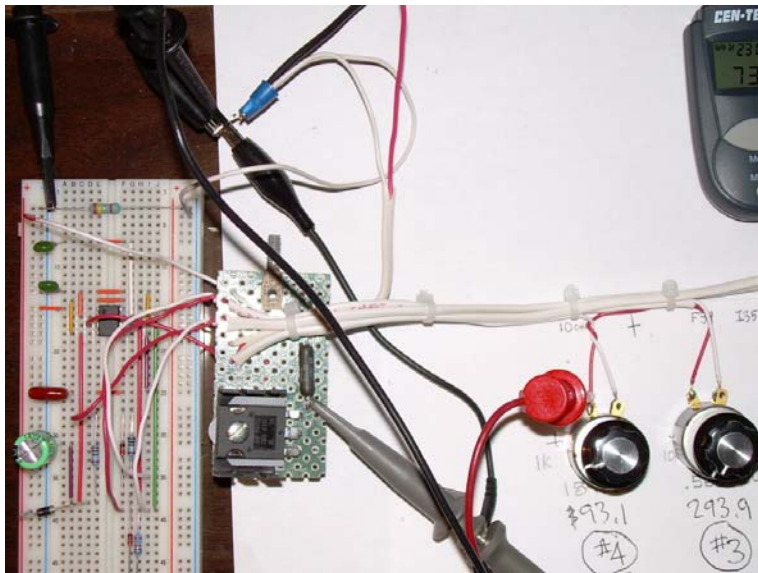
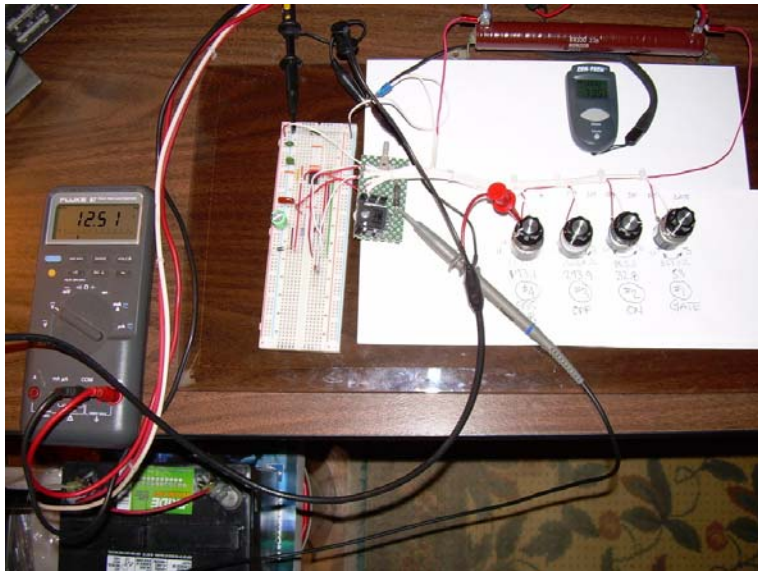

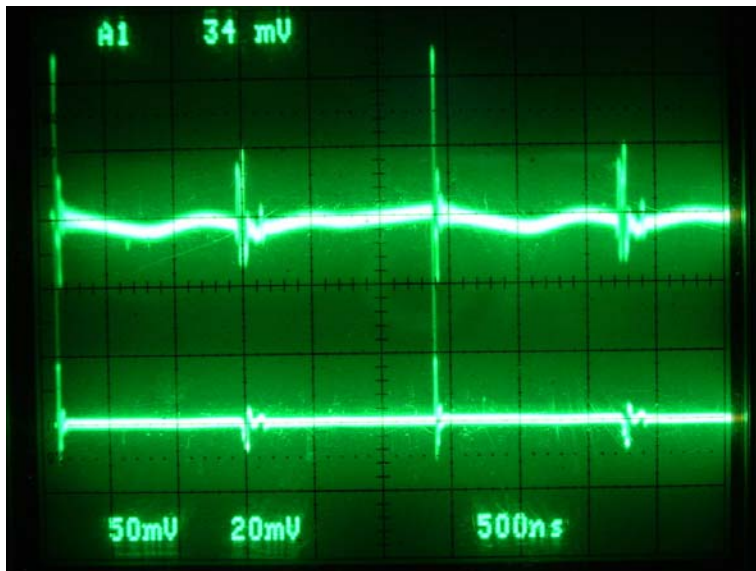
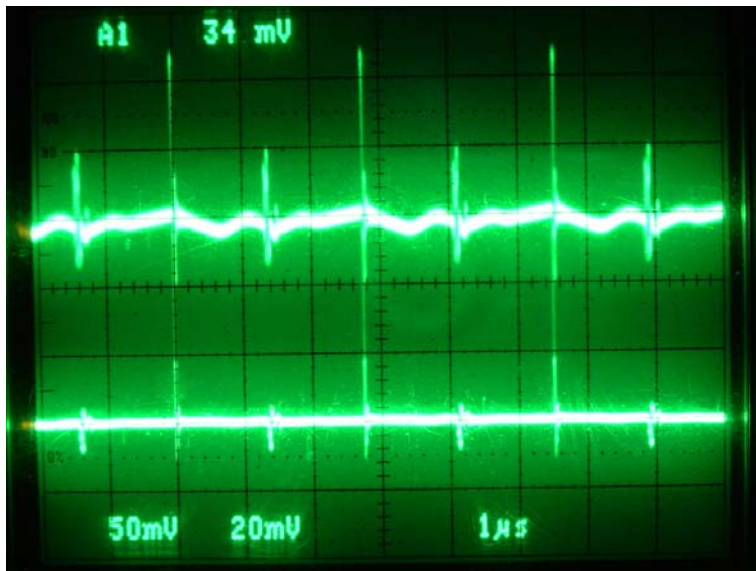



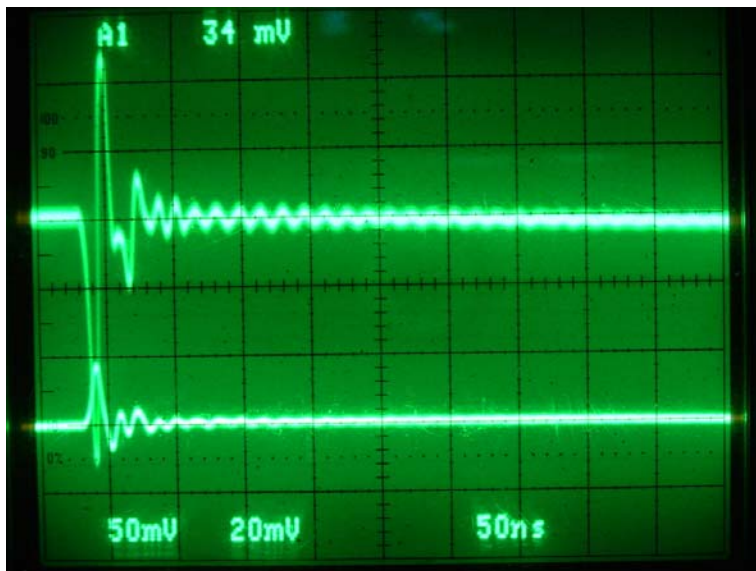
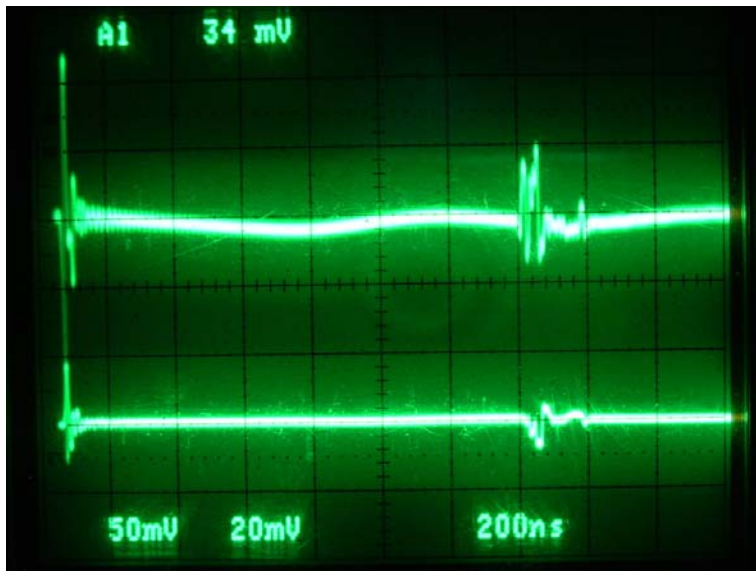

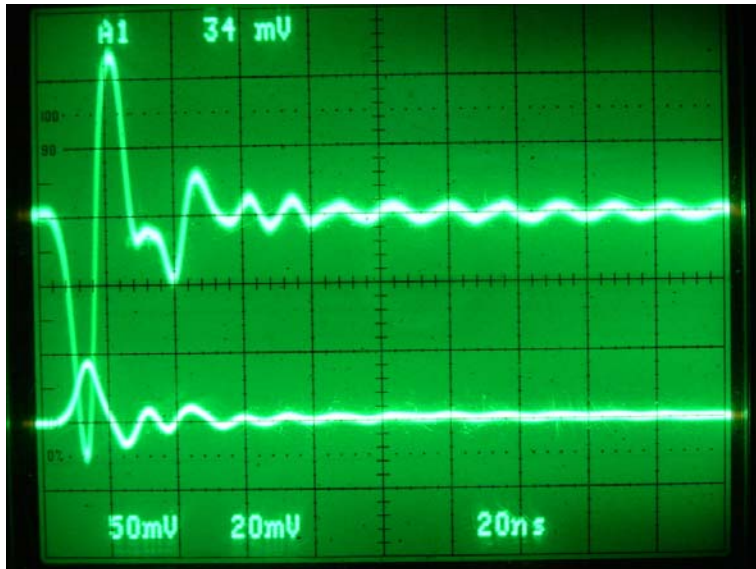
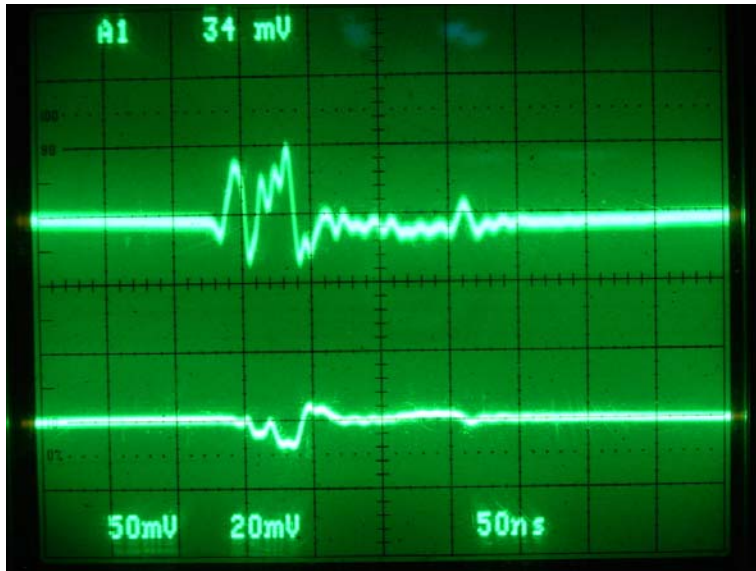

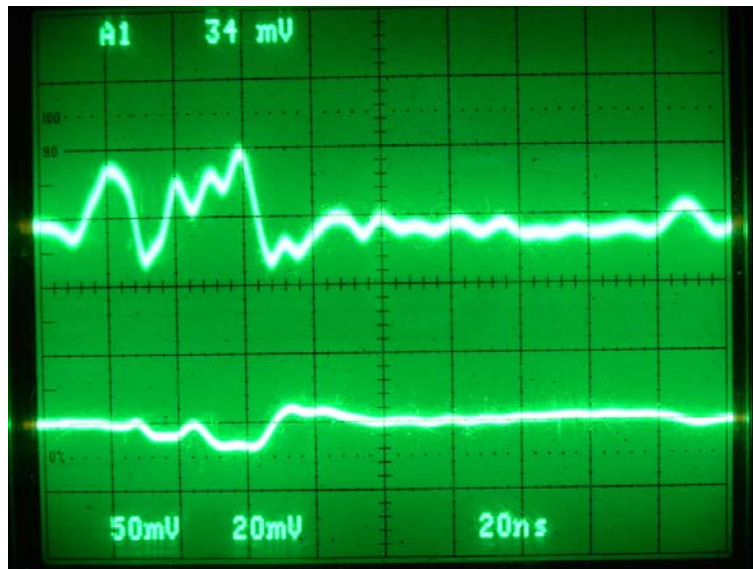

**Scope shots on the source waveform superimposed with the drain waveform for timing comparison and the timer duty cycle plus running frequency.**

These are some images prior to the 6 hour test on the [Rosemary Ainslie COP>17 Heater Circuit](#). I just performed and will be posting later with excellent results, a hint are in the images here.

**The Images are from the Tektronix TDS 3054C -USB Flash Drive**

Channel 1 - Mosfet source

Channel 2 - Mosfet drain

Channel 3 - 555 pin #3

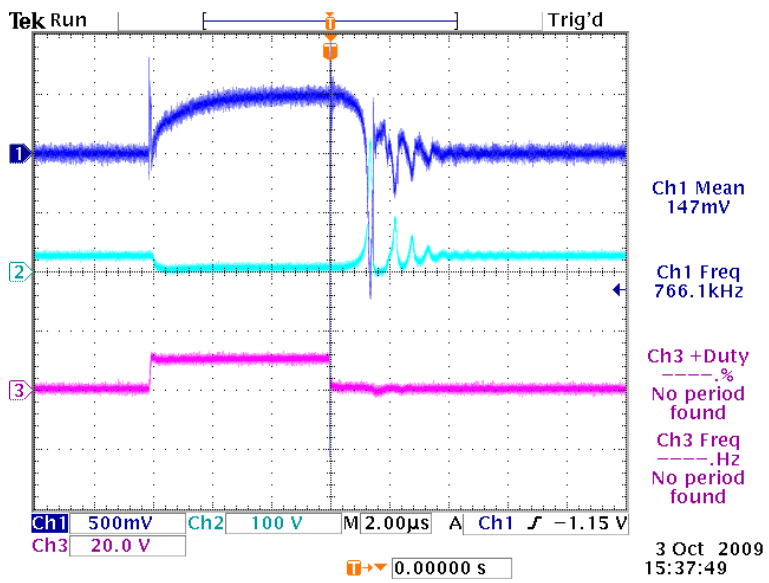
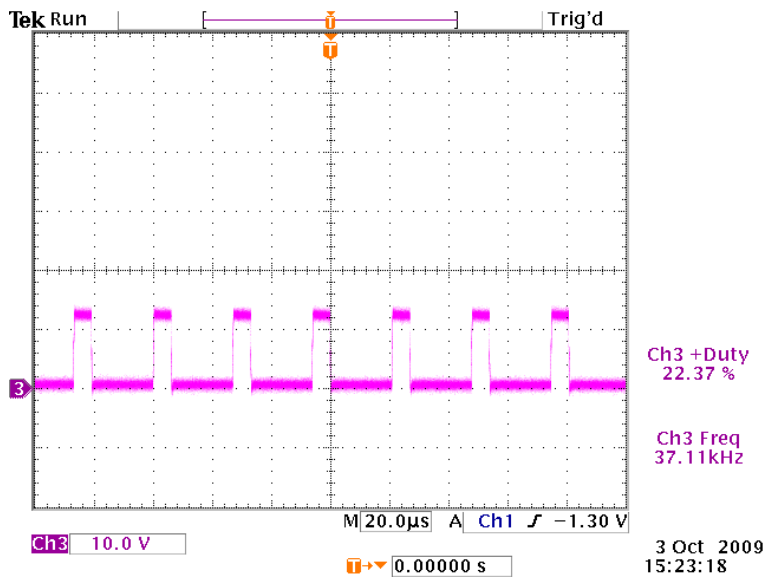

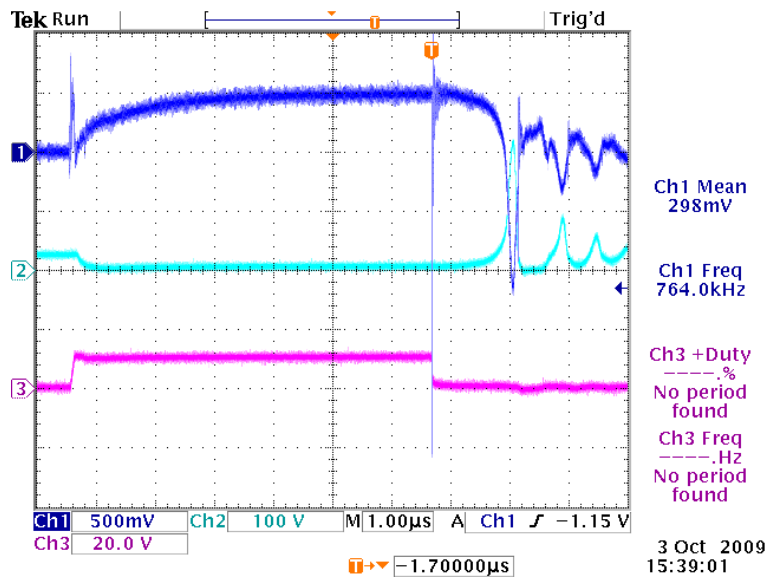

### **Glen's Rosemary Ainslie COP>17 Heater Circuit - TEST #1**

Here is the first test of the [Rosemary Ainslie COP>17 Heater Circuit](#) replication of the ["Quantum" October 2002](#) article.

All Images and data from the **Tektronix TDS 3054C** on loan from the Tektronix Corporation

[Rosemary Ainslie COP>17 Heater Circuit](#)  
["Quantum" October 2002](#)

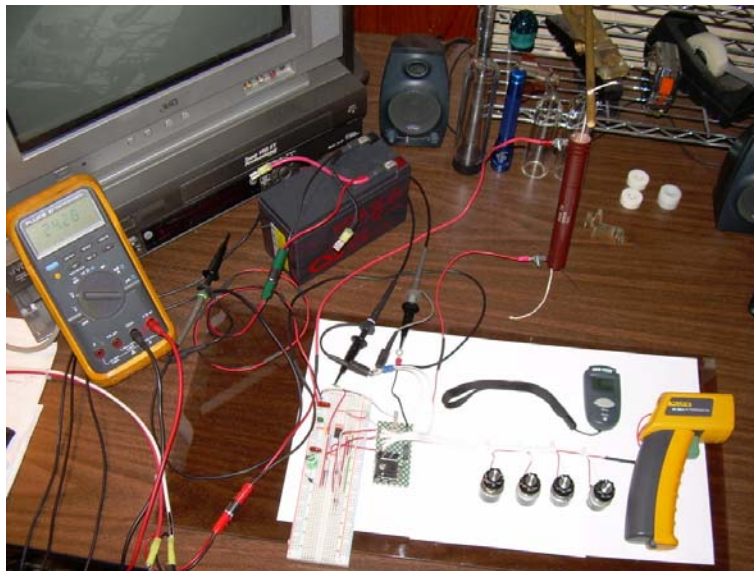

Replication Components -

- 1) International Rectifier - IRFPG50 HEXFET® Power MOSFET  
w/ Sil-Pad insulator between Mosfet and Heat Sink
- 2) Fairchild Semiconductor - NE555N Timer
- 3) Vishay Spectrol - SP534 Precision Potentiometer/ 10-turn 2-Watt
- 4) Exide Technologies Battery "Liquid Lead Acid" Model # GT-H - TRACTOR 12V 12Ah  
CCA 235
- 5) CSB Battery Company "Gel Lead Acid" #GP 1270 F2 / 12 Volt 7.0 Ah
- 6) Test Load Resister "MEMCOR" #FR100 - 10 ohm + - 5%, 100 watt, 20 to 26 uH

Temperature Measurements -

Fluke 62 "mini" IR Thermometer ( used maximum reading on each componenet )

Digital Mult Meter -

Fluke 87 DMM true RMS

**Channel 1 - Mosfet shunt**  
**Channel 3 - 555 Timer pin #3**  
**Channel 4 - 24 VDC "Liquid" Lead Acid Battery Bank**

**2us Start**

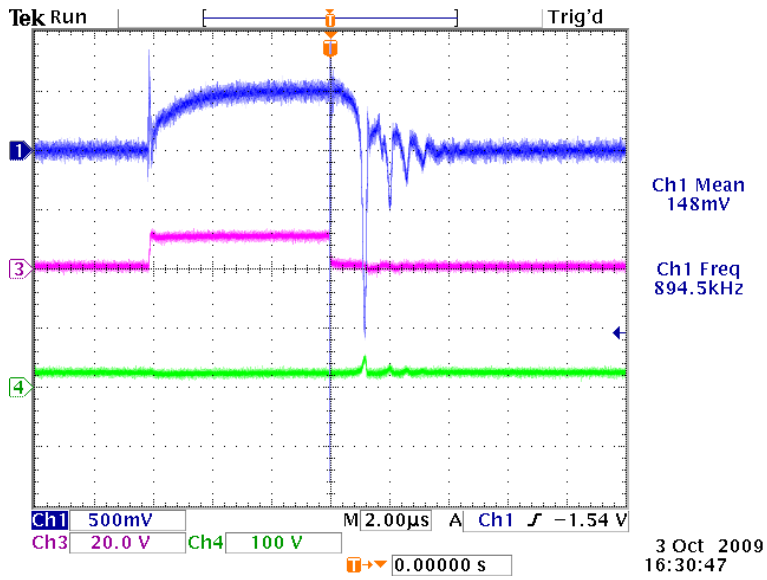

20us Start

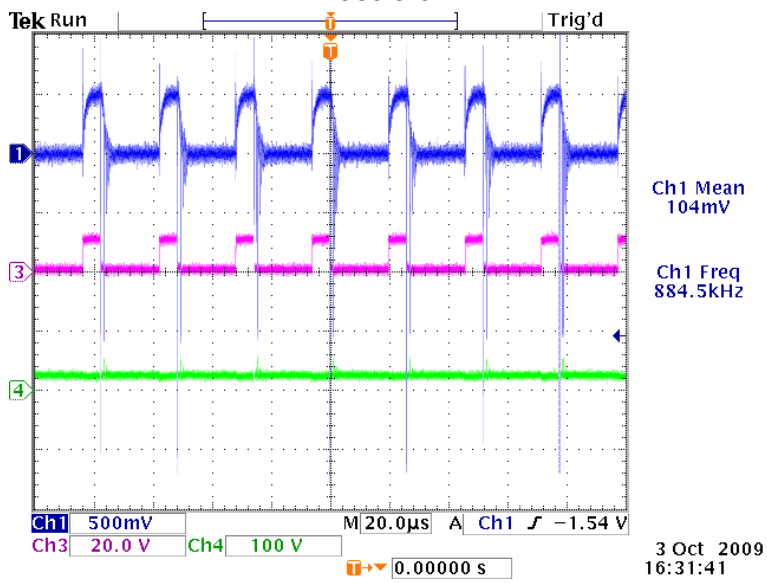

2us Finish

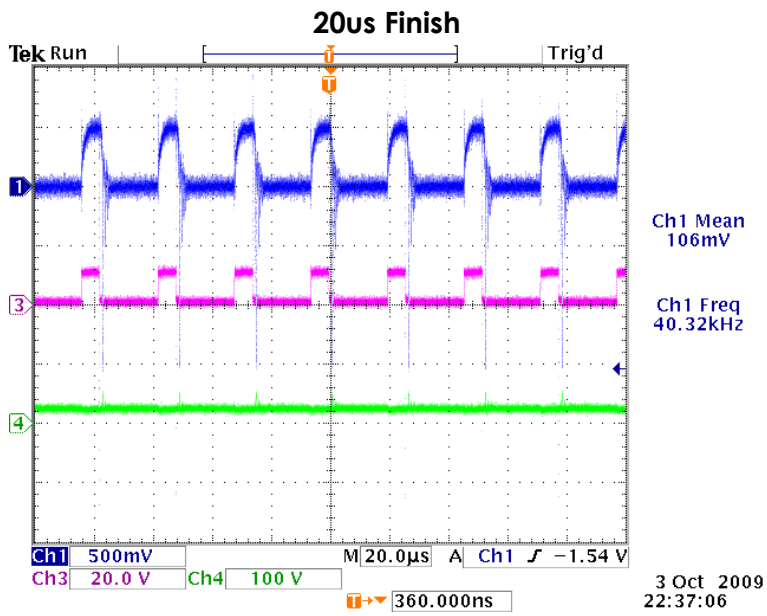
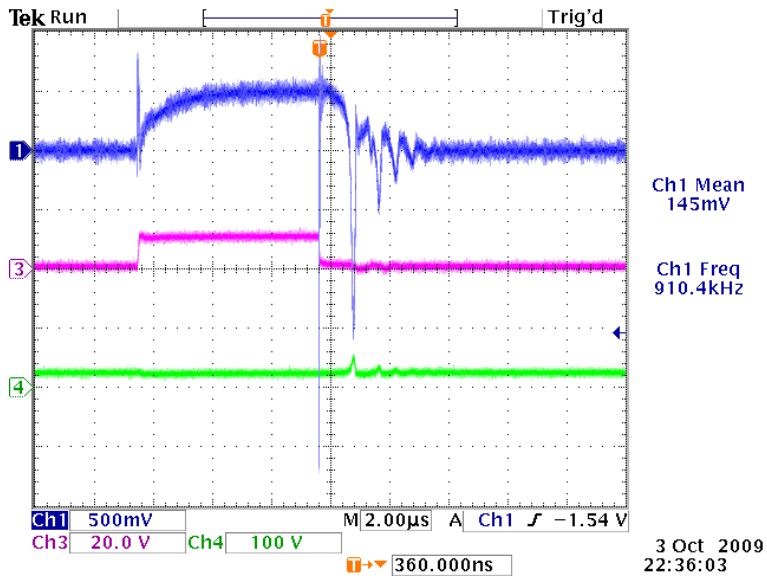

TEMPERATURE DATA -



# of 2 " LOAD RESISTOR " - 10J 100W COP217

FINISH { 20us - 10.PNG / 5.CSV } { 20us - 12.PNG / 7.CSV }  
 { 20us - 11.PNG / 6.CSV } { 20us - 13.PNG / 8.CSV }

DATE	TEST #	TIME	AMBIANT °F	LOAD 10J °F	MOSFET °F	555 °F	POTS °F	BAT V
3								
		16:35	76.4	151	190	96	79	24.79
		16:40	76.6	157	191	92	80	24.78
		16:45	76.6	154	190	100	80	24.77
		16:50	76.6	155	192	99	79	24.76
		16:55	76.6	152	189	97	79	24.76
		17:00	76.6	154	188	97	79	24.75
		17:05	76.6	156	187	98	80	24.74
		17:10	76.8	154	189	96	79	24.74
		17:15	76.8	155	190	96	80	24.73
		17:20	76.9	152	190	98	79	24.73
		17:25	76.9	153	188	98	80	24.72
		17:30	76.9	156	188	97	79	24.72
		17:35	X 76.9	155	189	102	80	24.71
		17:40	76.9	160	189	95	79	24.71
		17:45	77.0	163	187	95	80	24.70
		17:50	77.0	163	190	95	80	24.70
		17:55	77.0	162	190	99	80	24.69
		18:00	77.0	163	188	97	80	24.69
		18:05	77.1	163	193	96	80	24.68
		18:10	77.1	162	192	93	80	24.68
		18:15	77.1	163	188	93	80	24.67
		18:20	77.1	163	188	99	80	24.67
		18:25	77.1	163	192	97	80	24.66
		18:30	77.1	163	188	99	80	24.66
		18:35	X 77.1	164	191	95	80	24.65
		18:40	77.1	164	193	94	80	24.65
		18:45	77.2	164	185	98	79	24.64
		18:50	77.2	163	187	95	80	24.64
		18:55	77.2	163	191	96	80	24.63
		19:00	77.2	164	190	99	80	24.63
		19:05	77.2	164	192	103	80	24.62
		19:10	77.2	164	189	98	80	24.62
		19:15	77.2	164	192	100	80	24.61
		19:20	77.2	164	191	98	80	24.61
		19:25	77.2	164	188	100	80	24.60
		19:30	77.2	164	188	95	80	24.60

4- 24V BATTERY

3- TIMING

1- MOSFET

#2 of 2

LOAD RESISTOR - 10Ω 100W

START { 2.0S - 10.PNG / 5.CSV } FINISH { 2.0S - 12.PNG / 7.CSV }  
 { 2.0S - 11.PNG / 6.CSV } { 2.0S - 13.PNG / 8.CSV }

© WILSON JONES 1706 Copyright ©

DATE	TEST #	TIME	AMBIANT °F	LOAD 10Ω °F	MOSFET °F	555 °F	POTS °F	BAT V
3								
		19:35	77.2	164	192	97	80	24.59
		19:40	77.2	164	190	93	81	24.59
		19:45	77.2	163	191	99	81	24.58
		19:50	77.1	164	190	94	80	24.58
		19:55	77.2	164	192	95	80	24.57
		20:00	77.1	164	189	94	80	24.57
		20:05	77.0	164	192	94	81	24.56
		20:10	77.1	164	190	96	81	24.56
		20:15	77.1	164	191	102	80	24.55
		20:20	77.1	164	188	98	81	24.55
		20:25	77.1	163	191	97	81	24.54
		20:30	77.1	162	190	94	81	24.54
		20:35 X	77.0	162	189	95	81	24.53
		20:40	77.0	163	191	98	81	24.53
		20:45	77.0	162	190	96	81	24.52
		20:50	77.0	163	186	94	80	24.52
		20:55	76.9	163	188	97	80	24.51
		21:00	76.9	162	181	97	80	24.51
		21:05	76.9	163	188	95	80	24.50
		21:10	76.9	162	190	98	81	24.49
		21:15	76.9	162	191	93	80	24.49
		21:20	76.9	162	187	101	80	24.48
		21:25	76.9	161	187	95	80	24.48
		21:30	76.9	162	188	93	80	24.47
		21:35 X	76.9	161	187	95	80	24.46
		21:40	76.8	161	187	101	80	24.46
		21:45	76.8	162	189	94	80	24.45
		21:50	76.8	161	184	95	80	24.45
		21:55	76.8	162	188	94	81	24.44
		22:00	76.6	161	187	99	81	24.43
		22:05	76.6	161	185	97	80	24.42
		22:10	76.6	162	182	94	80	24.41
		22:15	76.6	160	187	96	80	24.40
		22:20	76.4	160	187	99	80	24.39
		20:25	76.6	161	187	104	80	24.38
		20:30	76.6	161	184	100	80	24.37
		20:35	76.6	160	186	96	80	24.36

4-2AY BATTERYS

2-55S

1-MOSFET

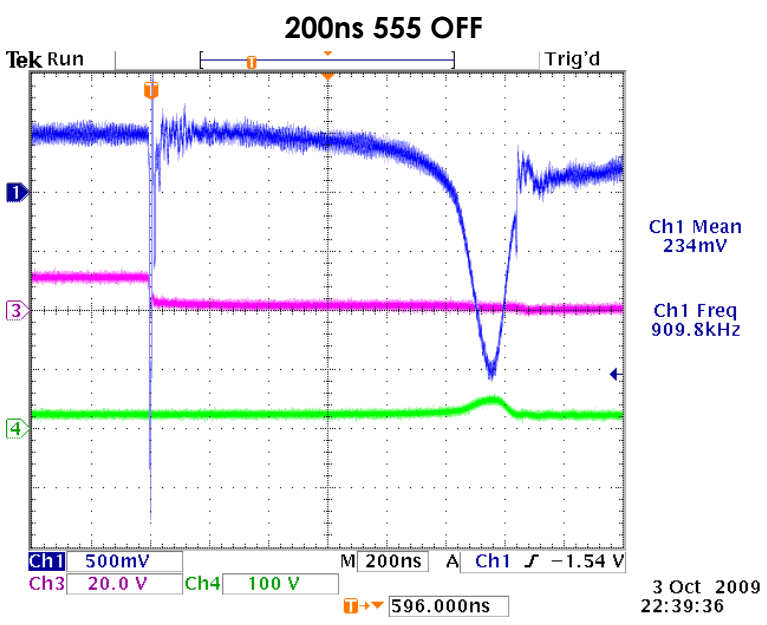

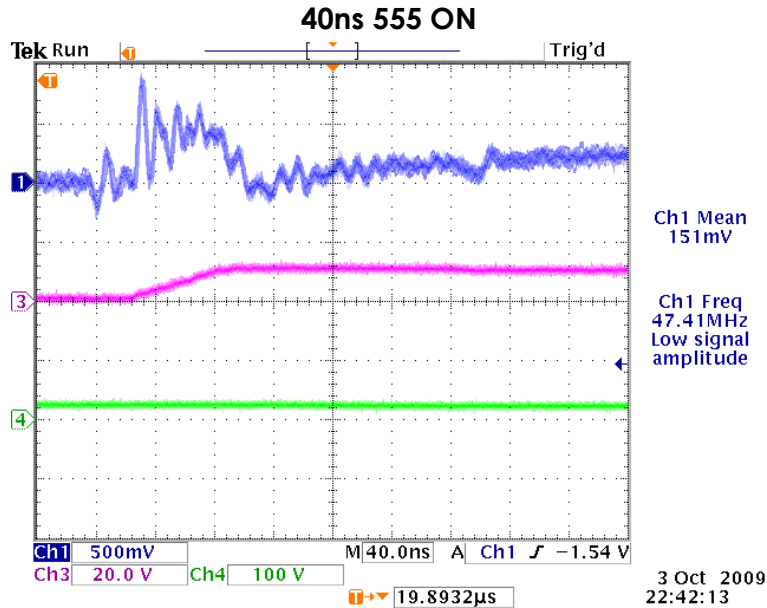

[Glen's Rosemary Ainslie COP>17 Heater Circuit – DATA TEST #1](#)

**Rosemary Ainslie COP>17 Heater Circuit - TEST #2**

Here is the second test of the [Rosemary Ainslie COP>17 Heater Circuit](#) replication of the "[Quantum](#)" [October 2002](#) article. It also includes a set of Mosfet Drain **360 Volt** spike images and data (spread sheet) .CSV files



All Images and data from the **Tektronix TDS 3054C** on loan from the Tektronix Corporation

**TEST #2**

[Rosemary Ainslie COP>17 Heater Circuit](#)  
["Quantum" October 2002](#)

**Replication Components -**

- 1) [International Rectifier - IRFPG50 HEXFET® Power MOSFET](#)  
w/ Sil-Pad insulator between Mosfet and Heat Sink
- 2) [Fairchild Semiconductor - NE555N Timer](#)
- 3) [Vishay Spectrol - SP534 Percision Potentiometer/ 10-turn 2-Watt](#)
- 4) [Exide Technologies Battery "Liquid Lead Acid" Model # GT-H - TRACTOR 12V 12Ah](#)  
[CCA 235](#)
- 5) CSB Battery Company "Gel Lead Acid" #GP 1270 F2 / 12 Volt 7.0 Ah
- 6) [Prototype - 10 Ohm resistor "Quantum Replication"](#)

*Temperature Measurements -*

Fluke 62 "mini" IR Themometer ( used maximum reading on each componenet )

*Digital Mulit Meter -*

Fluke 87 DMM true RMS

**Channel 1 - Mosfet source shunt**

**Channel 2 - Mosfet drain**

**Channel 3 - 555 Timer pin #3**

**Channel 4 - 24 VDC "Liquid" Lead Acid Battery Bank**

**2us Start**

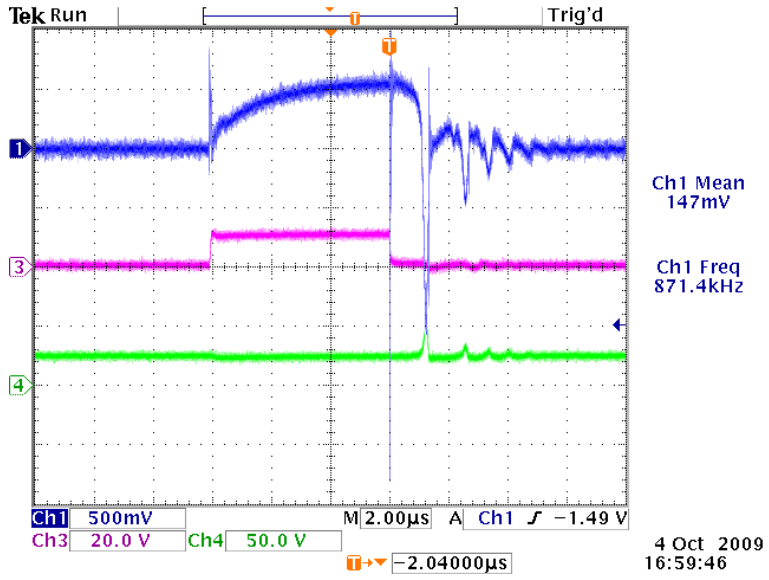

20us Start

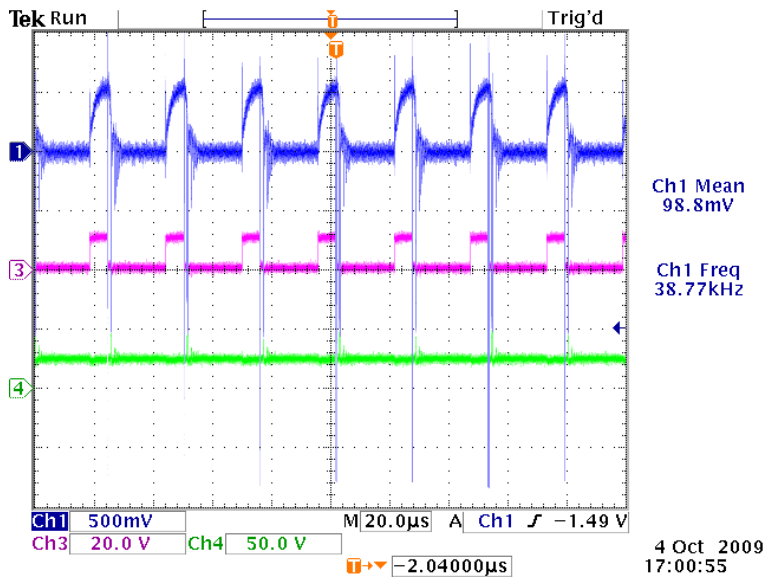

2us Finish

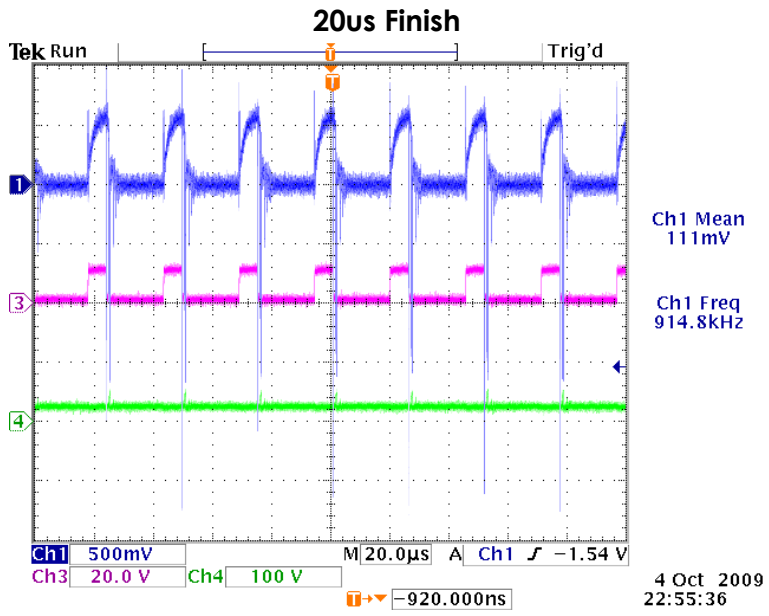
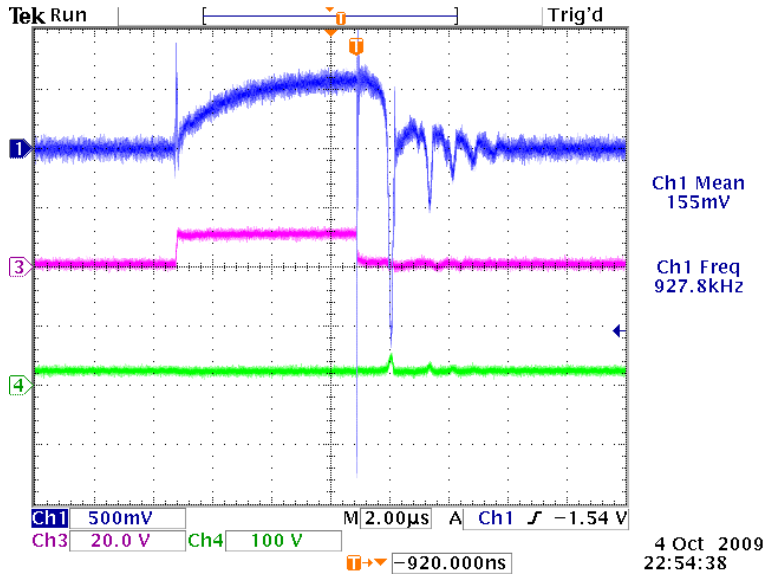

TEMPERATURE DATA SHEETS -

1 of 2

LOAD RESISTOR - 10Ω QUANTUM "PROTOTYPE"  
 (2us - 17 PkG / 9.4SV) (2us - 22 PkG / 11.4SV)  
 START (20us - 18 PkG / 10.4SV) FINISH (20us - 23 PkG / 12.4SV)

DATE	TEST #	TIME	AMBIANT F <sub>0</sub>	LOAD 10Ω F <sub>0</sub>	MOSFET F <sub>0</sub>	555 F <sub>0</sub>	POTS F <sub>0</sub>	BAT V
		17:00	X 75.4	131	210	95	80	25.08
		17:05	75.5	140	209	96	80	25.06
		17:10	75.5	143	209	95	80	25.06
		17:15	75.6	147	210	94	79	25.05
		17:20	75.8	150	207	99	80	25.04
		17:25	75.9	150	208	104	80	25.04
		17:30	76.1	151	201	96	80	25.02
		17:35	76.1	151	208	96	80	25.02
		17:40	76.2	151	209	94	80	25.01
		17:45	76.2	151	210	94	81	25.00
		17:50	76.3	151	210	94	80	24.99
		17:55	76.4	151	212	95	81	24.98
	→	18:00	X 76.4	151	213	95	80	24.97
		18:05	76.6	151	207	99	80	24.96
		18:10	76.6	151	213	96	80	24.95
		18:15	76.6	151	208	96	80	24.94
		18:20	76.6	151	208	95	80	24.94
		18:25	76.6	151	202	94	80	24.93
		18:30	76.6	150	211	93	80	24.92
		18:35	76.6	151	208	94	80	24.91
		18:40	76.6	150	208	97	80	24.90
		18:45	76.6	151	210	100	80	24.90
		18:50	76.6	150	208	99	80	24.89
		18:55	76.6	151	204	97	80	24.88
	→	19:00	X 76.6	151	205	94	80	24.87
		19:05	76.6	151	207	100	80	24.87
		19:10	76.6	151	208	94	80	24.86
		19:15	76.6	151	211	94	80	24.85
		19:20	76.6	151	205	96	80	24.85
		19:25	76.6	150	208	97	80	24.84
		19:30	76.6	150	209	96	80	24.83
		19:35	76.6	150	209	96	80	24.83
		19:40	76.4	150	211	104	80	24.82
		19:45	76.4	151	210	102	80	24.81
		19:50	76.4	150	206	98	80	24.81
		19:55	76.4	150	211	96	81	24.80

4 - 24V BATTERY 5

2 - 555 TIMER

1 - MOSFET

2 of 2

LOAD RESISTOR - 10 Ω QUANTUM "PROTOTYPE"

START 20us - 16 PkG / 9.6SV  
20us - 17 PkG / 10.6SV

FINISH 20us - 22 PkG / 11.6SV  
20us - 23 PkG / 12.6SV

© WILSON JONES 2700 Columbus Dr

DATE	TEST #	Z TIME	AMBIANT F°	LOAD 10 Ω F°	MOSFET F°	555 F°	POTS F°	BATV
4								
1		20:00	X 76.3	150	208	94	80	24.80
2		20:05	76.3	151	204	95	81	24.79
3		20:10	76.3	150	209	93	81	24.78
4		20:15	76.3	150	206	95	80	24.78
5		20:20	76.3	150	202	94	80	24.77
6		20:25	76.4	150	207	95	80	24.77
7		20:30	76.4	151	209	94	80	24.76
8		20:35	76.4	150	207	96	80	24.76
9		20:40	76.3	150	211	94	80	24.75
10		20:45	76.2	150	205	101	80	24.74
11		20:50	76.2	150	207	96	80	24.74
12		20:55	76.2	150	206	93	80	24.73
13	→	21:00	X 76.3	150	201	94	80	24.73
14		21:05	76.3	150	210	93	80	24.72
15		21:10	76.2	150	209	104	80	24.72
16		21:15	76.2	150	205	93	79	24.71
17		21:20	76.2	149	205	93	80	24.71
18		21:25	76.2	150	207	97	80	24.70
19		21:30	76.3	150	208	100	80	24.70
20		21:35	76.3	150	204	94	80	24.69
21		21:40	76.2	149	207	93	80	24.69
22		21:45	76.1	150	205	94	80	24.68
23		21:50	76.1	150	203	94	80	24.68
24		21:55	76.1	149	203	97	80	24.67
25	→	22:00	X 76.1	150	206	100	80	24.67
26		22:05	76.0	150	206	95	80	24.66
27		22:10	75.9	149	209	98	79	24.66
28		22:15	75.9	150	208	102	81	24.66
29		22:20	75.9	149	206	96	80	24.65
30		22:25	76.0	149	203	93	79	24.65
31		22:30	75.9	150	208	95	80	24.64
32		22:35	75.9	149	204	95	80	24.64
33		22:40	75.8	149	203	94	80	24.63
34		22:45	75.8	150	202	96	80	24.63
35		22:50	75.8	150	205	100	79	24.62
36		22:55	75.8	149	204	94	80	24.62

4-2AY BATTERYS

2-555 TIMER

1-MOSFET

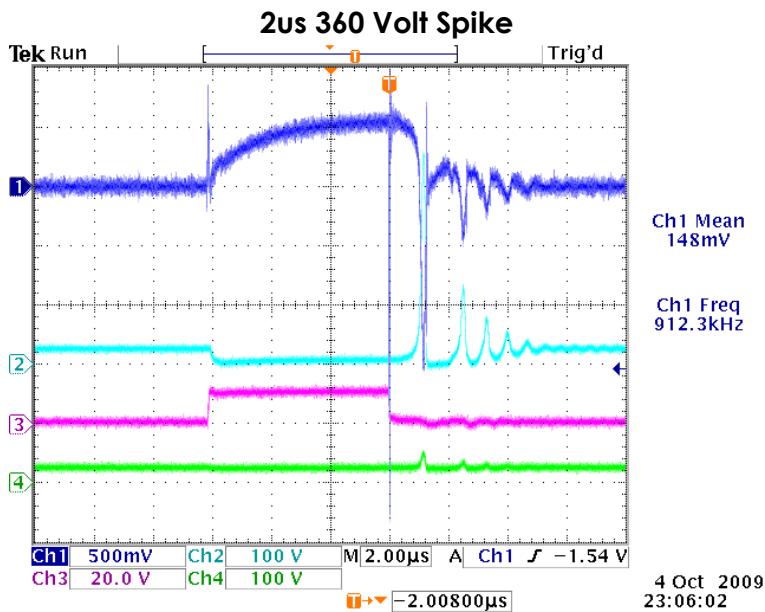

1us 360 Volt Mosfet Drain Spike



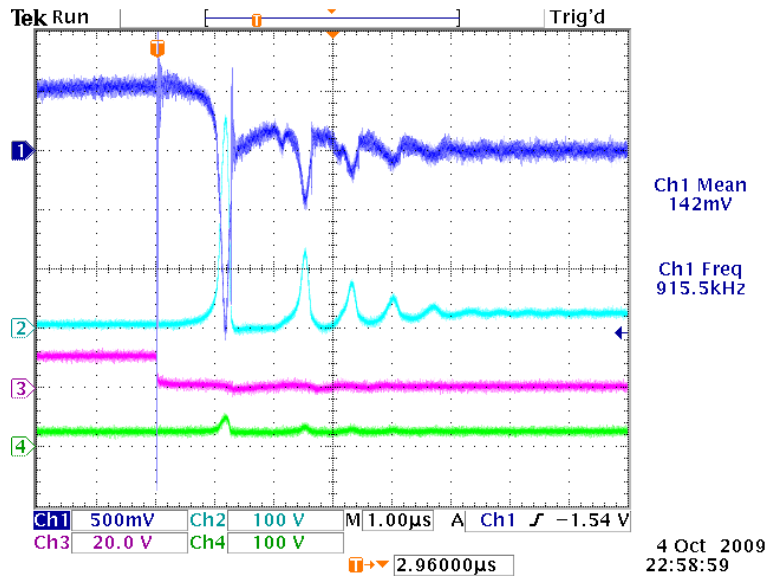

### 400ns 360 Volt Mosfet Drain Spike

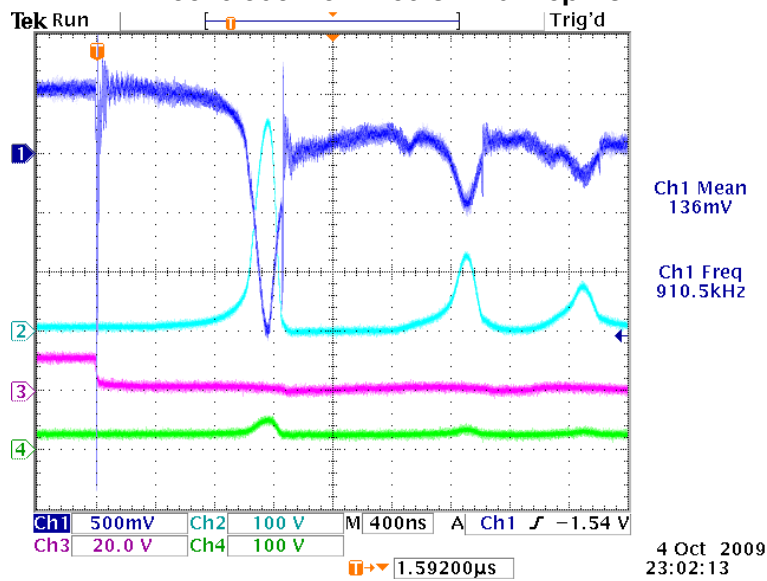

## Glen's Rosemary Ainslie COP>17 Heater Circuit – DATA TEST #2

### [Rosemary Ainslie COP>17 Heater Circuit - TEST #3](#)

Here is the data for test #3 This one is the best yet with Mosfet drain spikes of over 500 volts and 70 volt being returned to the 24 Volt battery bank. The test was ran over a 7 hour period (noted voltage loss **.23** volts)

Duty Cycle - 22% (measured prior to 24Volt Battery Bank Connection)

Ambient Temperature - 77 Degrees F

Mosfet Temperature - 154 Degrees F

Load Resistor Temperature - 130 Degrees F

Gate Potentiometer Resistance - 7.2 ohms

On Potentiometer Resistance - 0 ohms (minimum)

Off Potentiometer Resistance - 10,000 ohms (maximum)

### **TEST #3**

[Rosemary Ainslie COP>17 Heater Circuit](#)  
["Quantum" October 2002](#)

#### **Replication Components -**

- 1) [International Rectifier - IRFPG50 HEXFET® Power MOSFET](#)  
w/ Sil-Pad insulator between Mosfet and Heat Sink
- 2) [Fairchild Semiconductor - NE555N Timer](#)
- 3) [Vishay Spectrol - SP534 Percision Potentiometer/ 10-turn 2-Watt](#)
- 4) [Exide Technologies Battery "Liquid Lead Acid" Model # GT-H - TRACTOR 12V 12Ah](#)  
[CCA 235](#)
- 5) CSB Battery Company "Gel Lead Acid" #GP 1270 F2 / 12 Volt 7.0 Ah
- 6) Test Load Resister "Quantum" 10 ohm *Prototype*

#### ***Temperature Measurements -***

Fluke 62 "mini" IR Themometer ( used maximum reading on each componenet )

#### ***Digital Mulit Meter -***

Fluke 87 DMM true RMS

**CHANNEL 1 - Mosfet source**

**CHANNEL 2 - Mosfet drain**

**CHANNEL 3 - 555 timer pin #3**

**CHANNEL 4 - 24 Volt Battery Bank**

**40us**

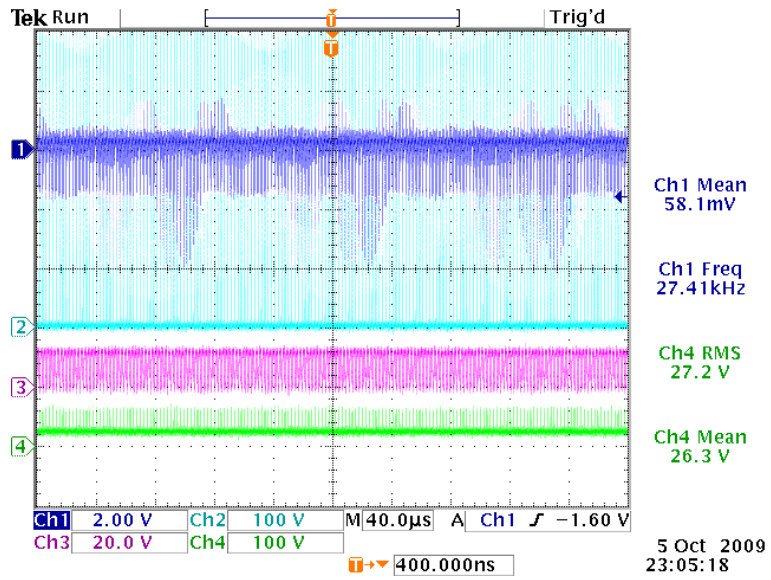

20us

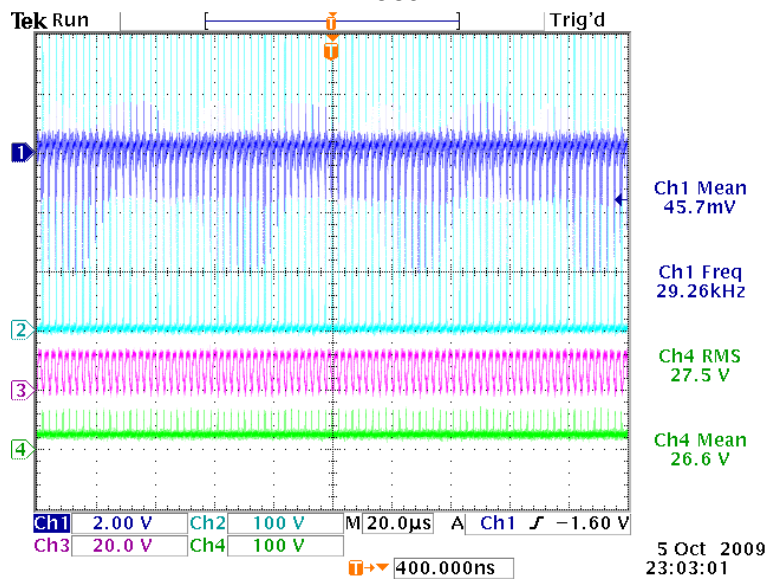

2us

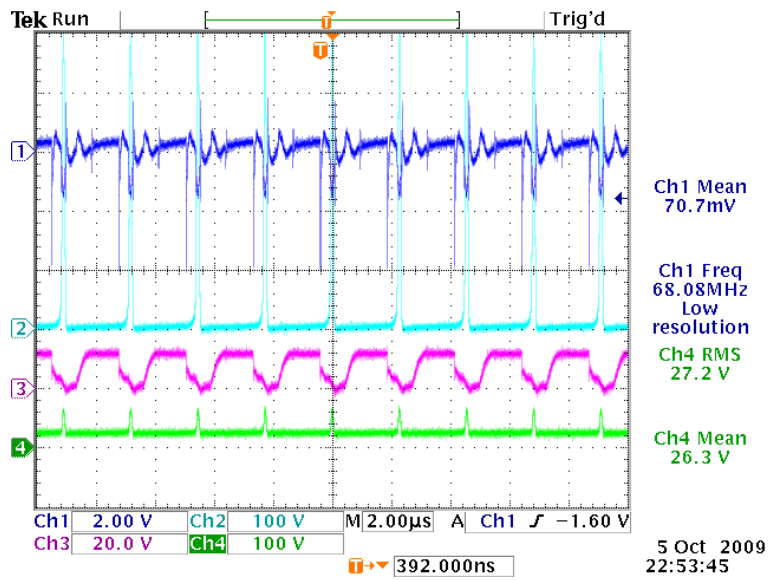

1µs

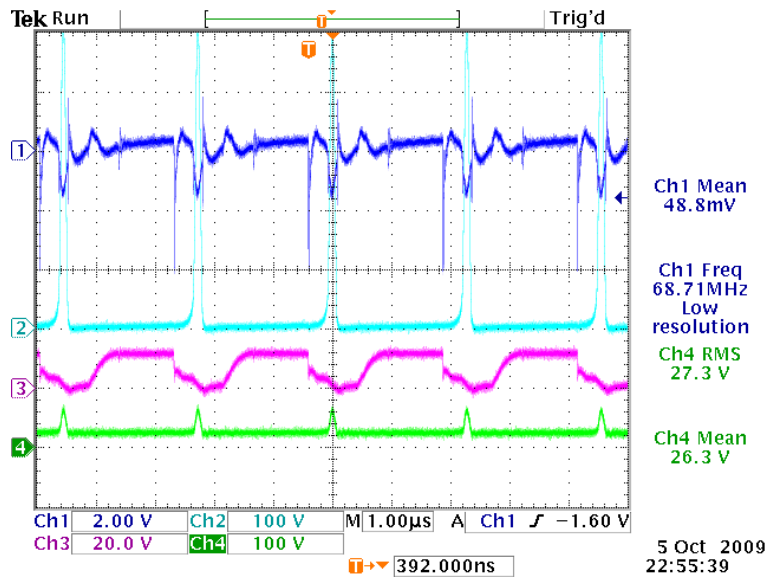

400ns

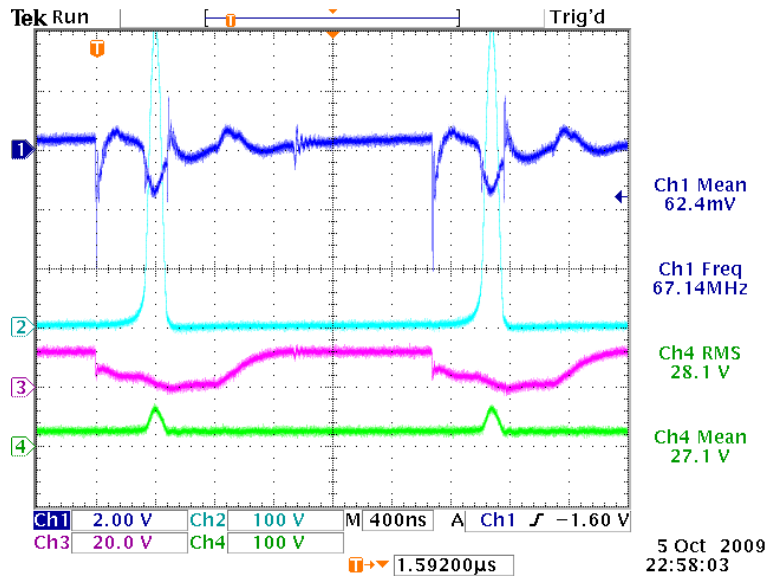

200ns

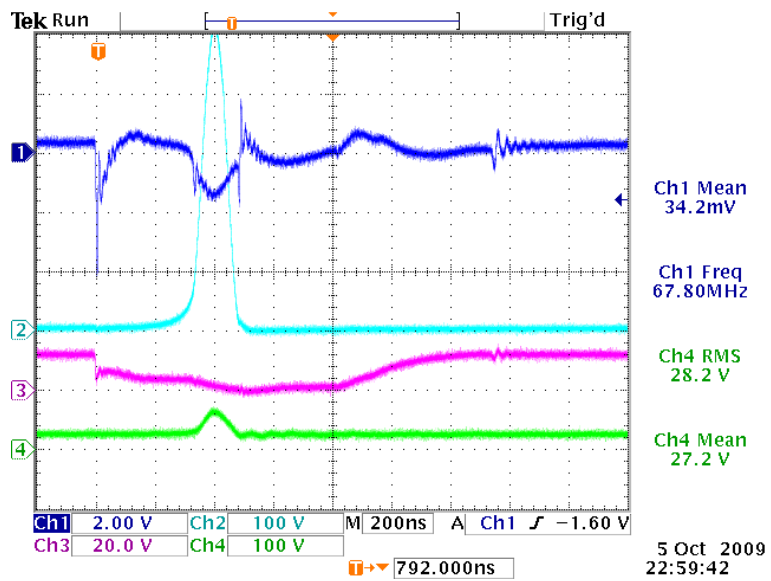

100ns

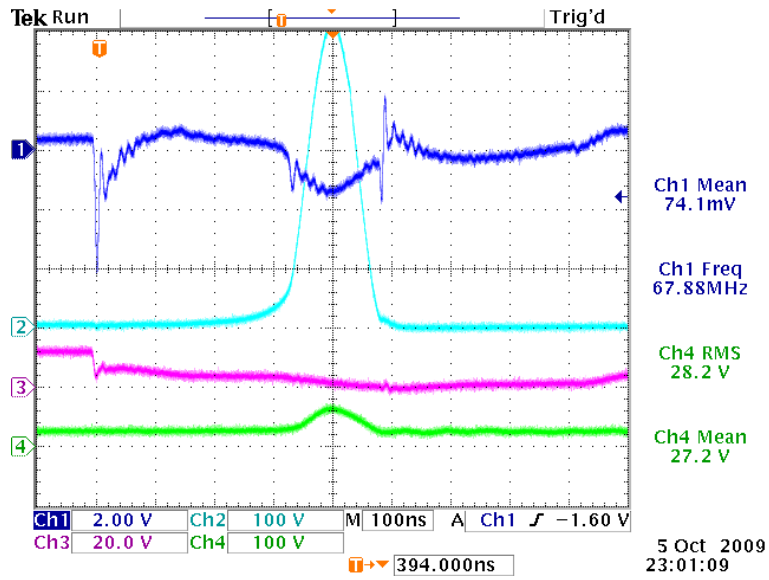

All Images and data from the Tektronix TDS 3054C on loan from the Tektronix Corporation

### 555 TIMER "OFF" 360 VOLT SPIKE

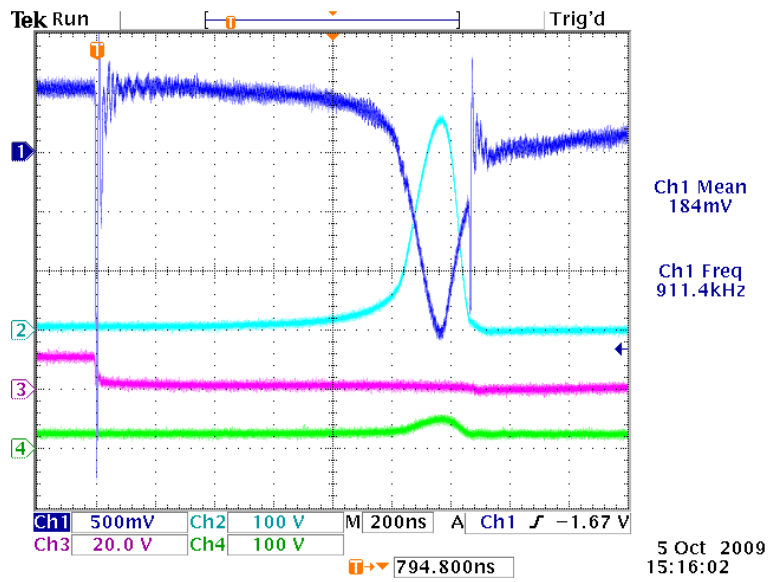

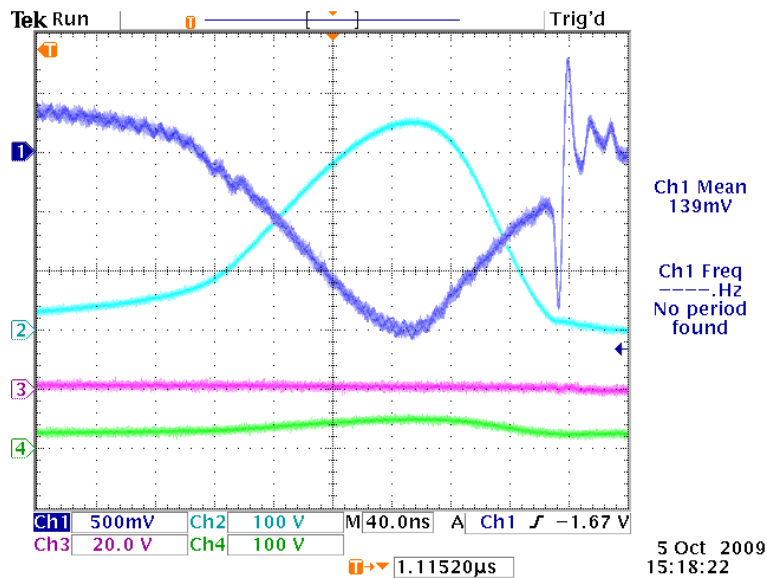
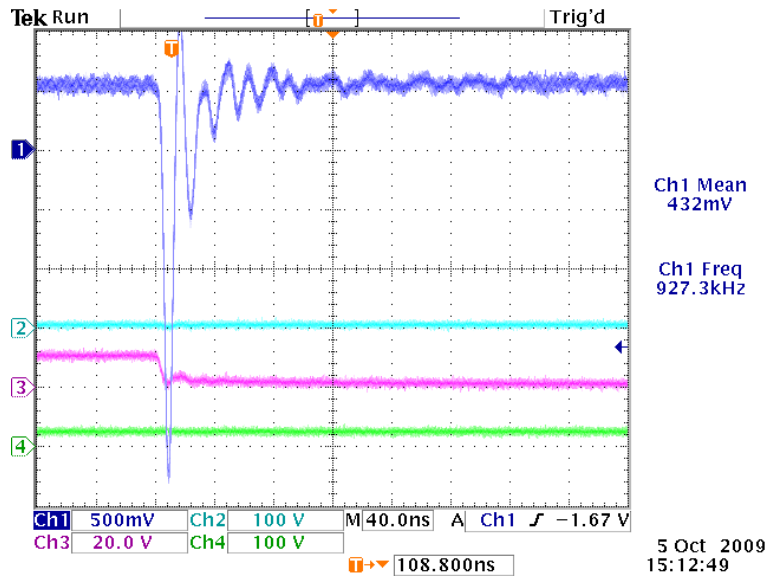

### Analogy of Test 3 from Harvey

Here are the totals from the 40µs\_520V\_10\_05\_09\_xlr:

We need to mention that these are straight Ohmic calculations and no effort has been made toward differentiating the current lead/lag in the inductor as we know the 'Drain' (CH2) value is not a purely resistive reference. However, preliminary observations would indicate a strong negative average on the battery power. This is corroborated by the reduced draw down rate as compared to previous runs not operating in this mode.

This data should be sufficient such that when compared to the thermal output it should confirm conclusively that the Rosemary Ainslie configuration does produce more output

power than it uses on average - unless of course I have made a mistake in my calculations above which is presented here for review.

-Glen's notes and response: The experimenters using a power supply for operating the 24VDC may not want to do this with 70 Volt spikes going back into their power supply, plus the gains might never show up ... power with nowhere to go. I'm just wondering how to capture more from the spikes but I'm sure it will come to me soon.

### [Glen's Rosemary Ainslie COP>17 Heater Circuit – DATA TEST #3](#)

#### **Rosemary Ainslie COP>17 Heater Circuit - TEST #4**

Here is a replication of TEST #3 with three (3) sets of images and data dumps taken seven times one set every hour for six hours plus temperature readings every 15 minutes. The Load Prototype "Quantum" 10 ohm resistor was mounted horizontal with two (2) size #5-1/2 rubber stoppers inserted in each end, elevated 3" from the desk surface.



#### **TEST #4**

[Rosemary Ainslie COP>17 Heater Circuit](#)  
["Quantum" October 2002](#)

#### **Replication Components -**

- 1) [International Rectifier - IRFPG50 HEXFET® Power MOSFET](#)  
w/ Sil-Pad insulator between Mosfet and Heat Sink
- 2) [Fairchild Semiconductor - NE555N Timer](#)



- 3) [Vishay Spectrol - SP534 Percision Potentiometer/ 10-turn 2-Watt](#)
- 4) [Exide Technologies Battery "Liquid Lead Acid" Model # GT-H - TRACTOR 12V 12Ah CCA 235](#)
- 5) CSB Battery Company "Gel Lead Acid" #GP 1270 F2 / 12 Volt 7.0 Ah
- 6) Prototype "Quantum" Load Resister 10 ohm + - 1%
- 7) [Shunt Resistor - "Dale" RS-2B 0.25 ohm, 3 watt, 3 %](#)

### Temperature Measurements -

Fluke 62 "mini" IR Themometer ( used maximum reading on each componenet )

### Digital Mulit Meter -

Fluke 87 DMM true RMS

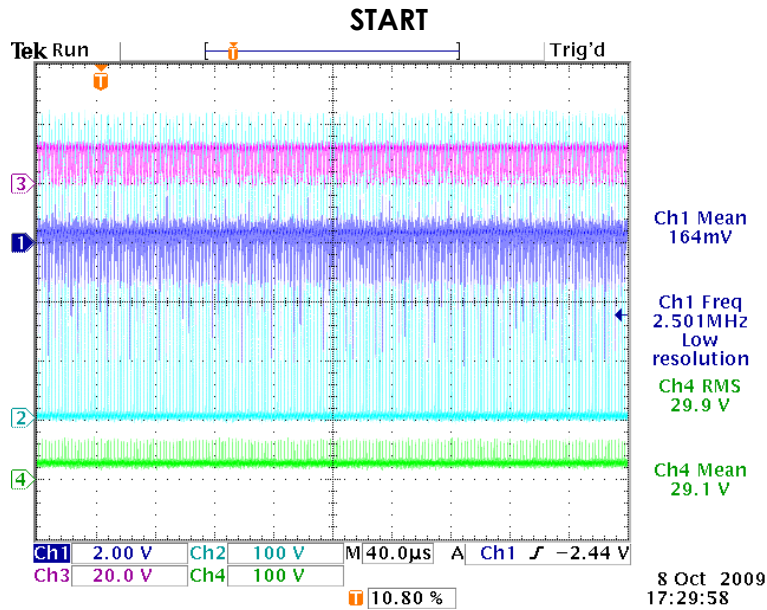

**HOUR 2**

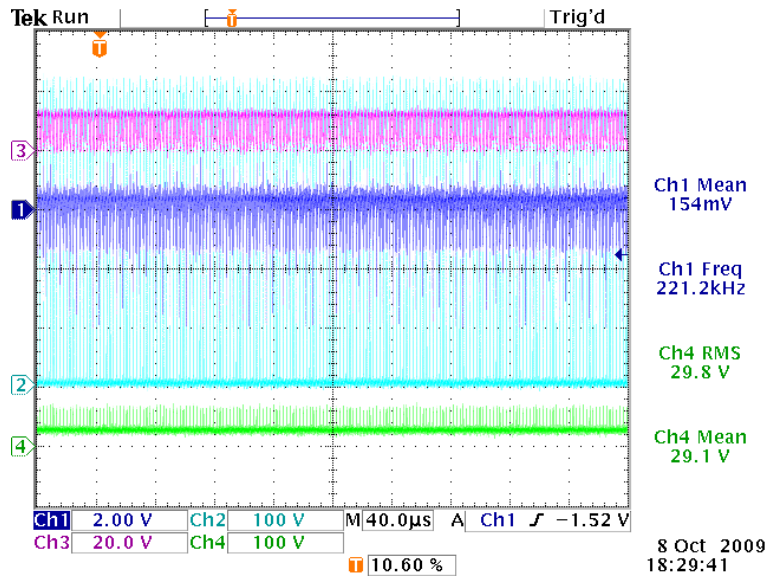

### HOUR 3

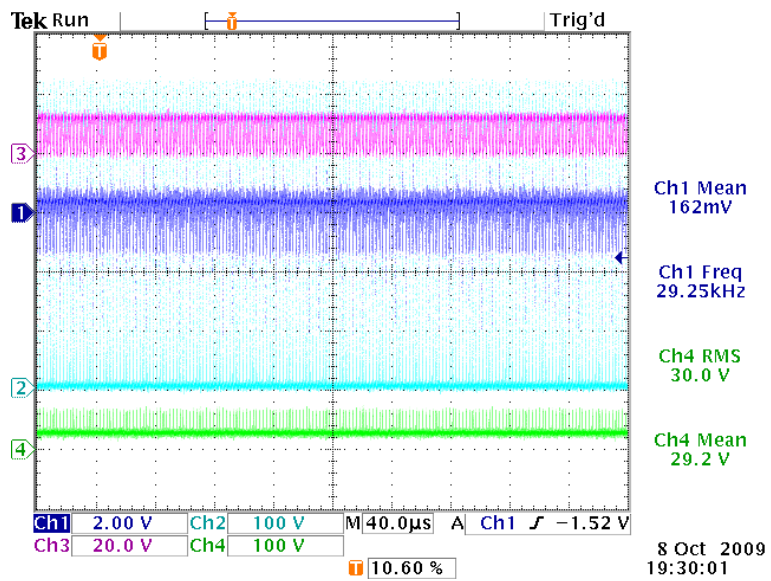

### HOUR 4

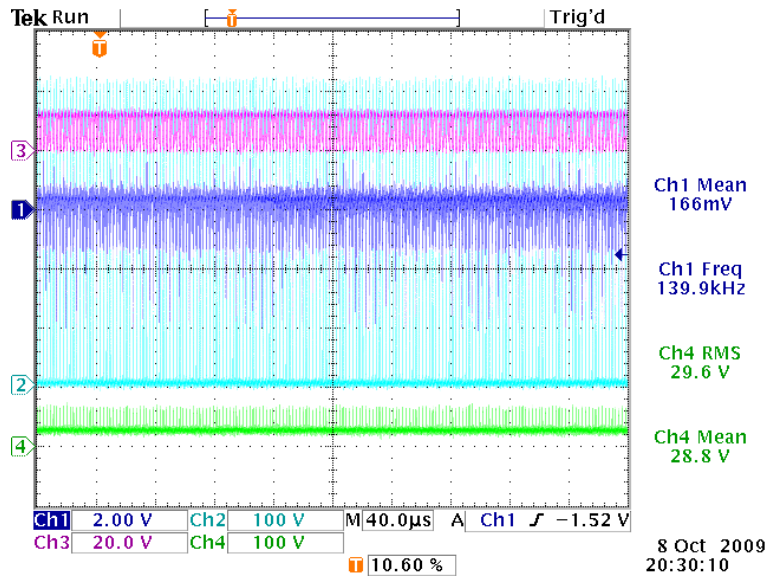

### HOUR 5

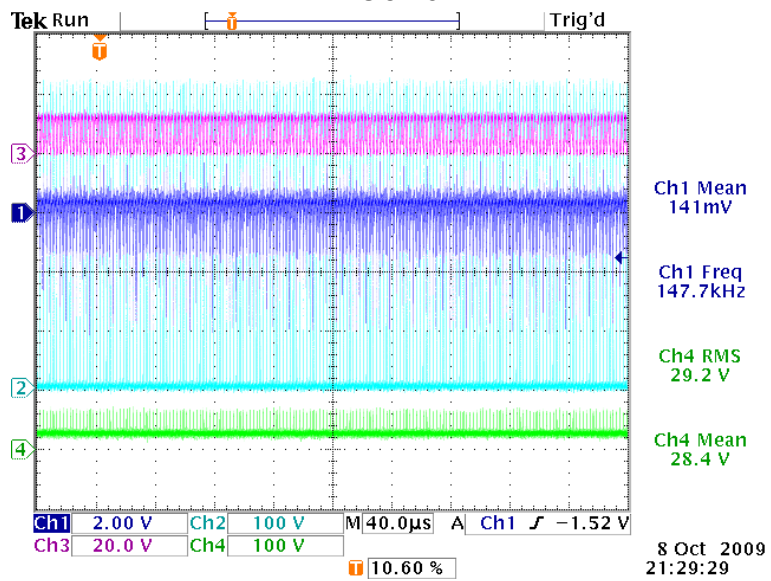

### HOUR 6

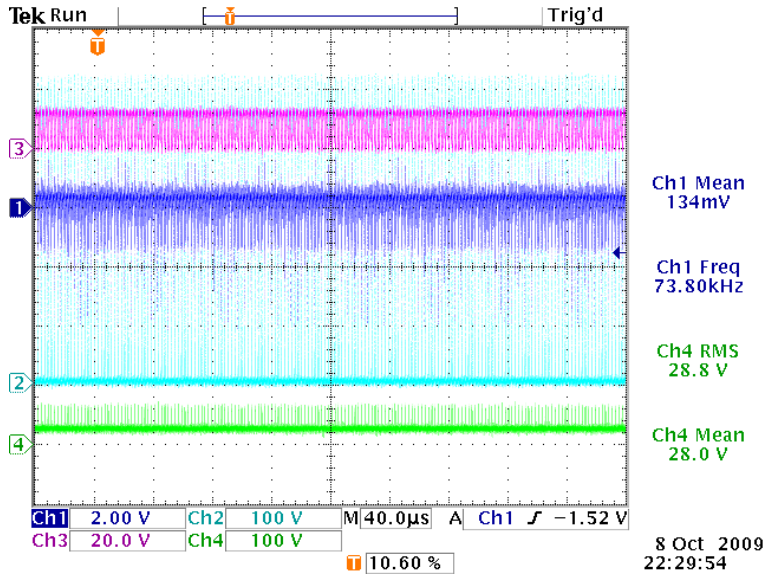

**FINISH - END OF TEST**

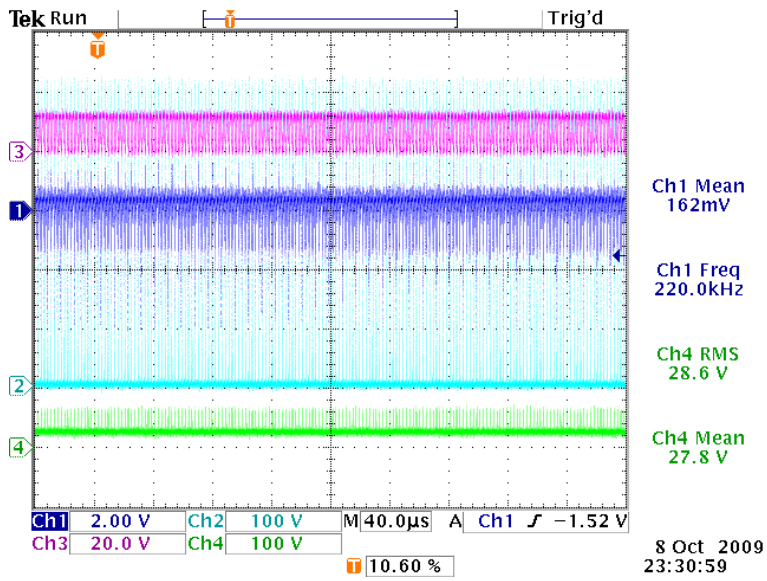

**TEMPERATURE DATA -**

520V-01 SETTINGS TEST #3 "DUPLICATION" TEST  
 10-08-09  
 © WILSON JONES 0708 Copyright ©

Prepared By: \_\_\_\_\_ Initials: \_\_\_\_\_ Date: \_\_\_\_\_  
 Approved By: \_\_\_\_\_

"HR" "15 MIN"

HR	DIV	IMAGE REF	DATA REF	LOAD VOL OF	AMBIENT	
1						
2	TIME 17:30	40us	0.PNG	0.CSV	115	78.7 ← START
3	DMM 24.93 V	20us	1.PNG	1.CSV	141	:15
4		2us	2.PNG	2.CSV	143	:30
5				144	80.3	:45
6	TIME 18:30	40us	4.PNG	4.CSV	144	80.4 :00
7	DMM 24.88 V	20us	5.PNG	5.CSV	145	80.6 :15
8		2us	6.PNG	6.CSV	144	80.7 :30
9				143	80.8	:45
10						
11						
12	TIME 19:30	40us	7.PNG	7.CSV	143	80.7 :00
13	DMM 24.83 V	20us	8.PNG	8.CSV	143	80.8 :15
14		2us	9.PNG	9.CSV	143	80.8 :30
15				143	80.7	:45
16						
17						
18	TIME 20:30	40us	10.PNG	10.CSV	142	80.5 :00
19	DMM 24.78 V	20us	11.PNG	11.CSV	142	80.4 :15
20		2us	12.PNG	12.CSV	141	79.9 :30
21				142	79.8	:45
22						
23	TIME 21:30	40us	13.PNG	13.CSV	142	79.4 :00
24	DMM 24.74 V	20us	14.PNG	14.CSV	142	79.3 :15
25		2us	15.PNG	15.CSV	142	79.3 :30
26				141	79.3	:45
27						
28	TIME 22:30	40us	16.PNG	16.CSV	142	79.1 :00
29	DMM 24.68 V	20us	17.PNG	17.CSV	141	79.1 :15
30		2us	18.PNG	18.CSV	141	79.1 :30
31				141	79.0	:45
32	"FINISH"	40us	19.PNG	19.CSV	141	78.9 :00
33	TIME 23:30	20us	20.PNG	20.CSV		
34	DMM 24.61 V	2us	21.PNG	21.CSV		
35						
36						
37						
38						
39						
40						

VIDEO →

All Images and data from the Tektronix TDS 3054C from the Tektronix Corporation

[Glen's Rosemary Ainslie COP>17 Heater Circuit – DATA TEST #4](#)

**Rosemary Ainslie COP>17 Heater Circuit - TEST #5**

This is a repeat attempt of the results on **TEST #3** with some new data which may surprise everyone but maybe not. The Load Prototype "Quantum" 10 ohm resistor was mounted vertical with two (2) size #5-1/2 rubber stoppers inserted in each end, elevated 3" from the desk surface.



### **TEST #5**

#### **Replication Components -**

- 1) [International Rectifier - IRFPG50 HEXFET® Power MOSFET](#)  
w/ Sil-Pad insulator between Mosfet and Heat Sink
- 2) [Fairchild Semiconductor - NE555N Timer](#)
- 3) [Vishay Spectrol - SP534 Percision Potentiometer/ 10-turn 2-Watt](#)
- 4) [Exide Technologies Battery "Liquid Lead Acid" Model # GT-H - TRACTOR 12V 12Ah CCA 235](#)
- 5) CSB Battery Company "Gel Lead Acid" #GP 1270 F2 / 12 Volt 7.0 Ah
- 6) Prototype "Quantum" Load Resister 10 ohm + - 1%
- 7) [Shunt Resistor - "Dale" RS-2B 0.25 ohm, 3 watt, 3 %](#)

#### **Temperature Measurements -**

Fluke 62 "mini" IR Themometer ( used maximum reading on each componenet )

#### **Digital Mulit Meter -**

Fluke 87 DMM true RMS

#### **Channel 1 - Mosfet source shunt**

Channel 2 - Mosfet drain  
 Channel 3 - 555 Timer pin #3  
 Channel 4 - 24 VDC "Liquid" Lead Acid Battery Bank

START

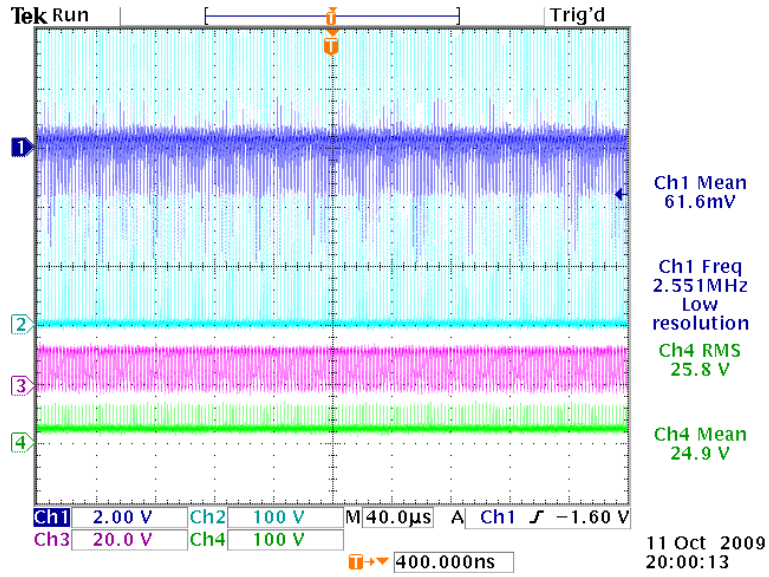

HOUR 2

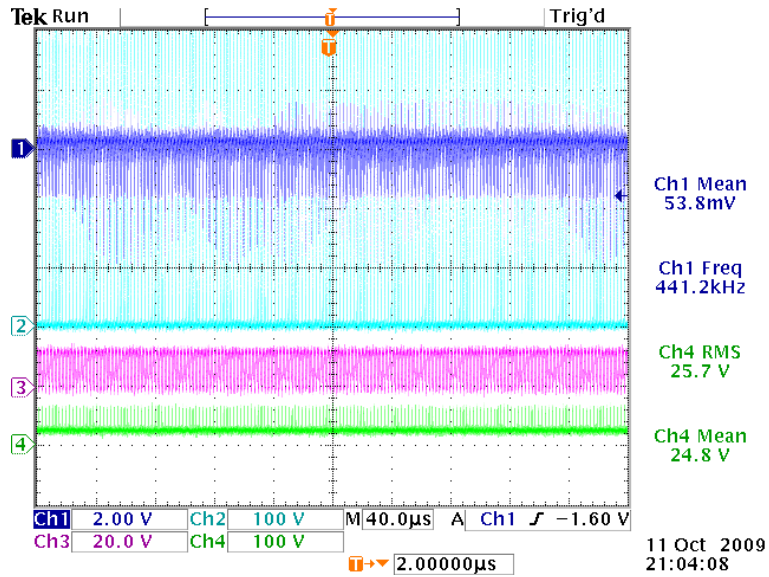

HOUR 3

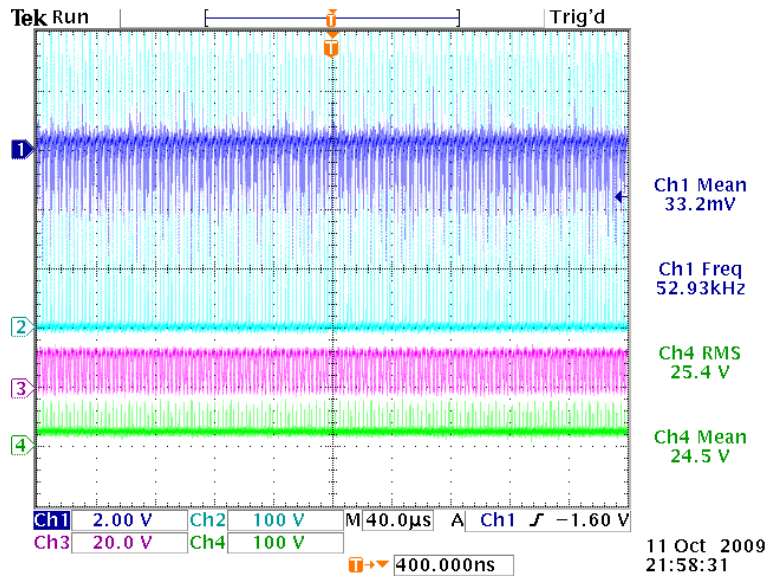

### HOUR 4

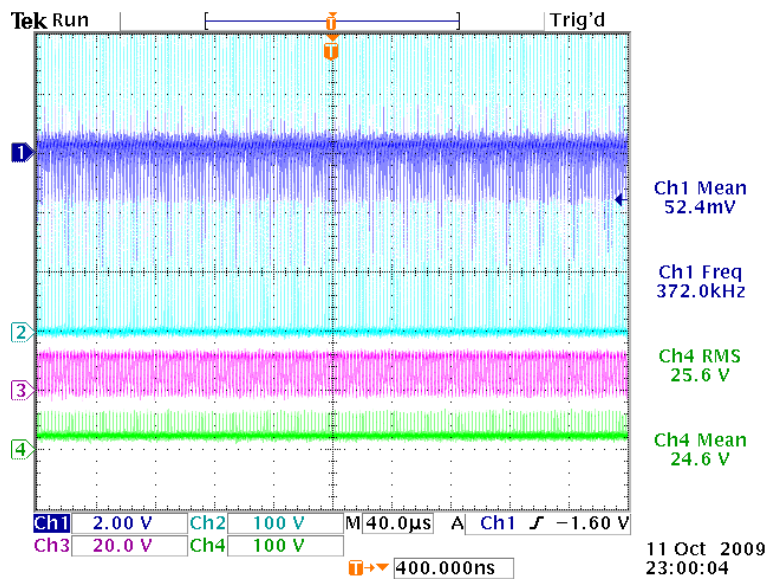

### HOUR 5



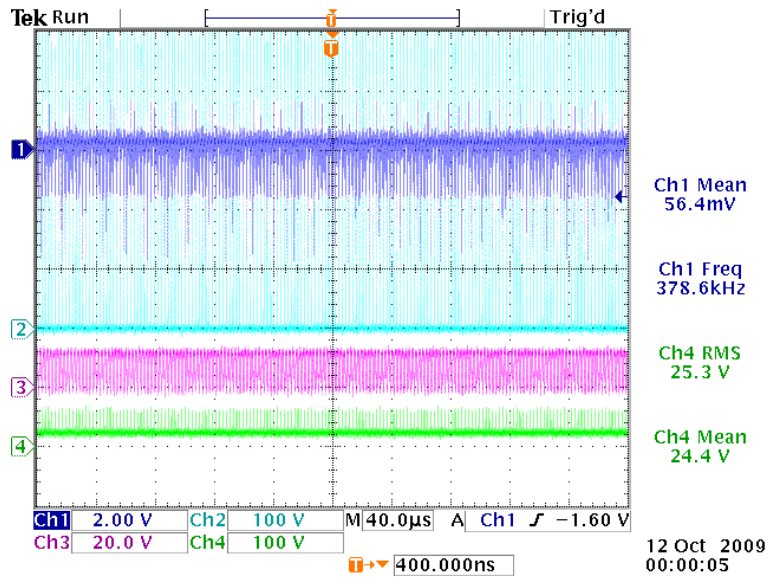

HOUR 6

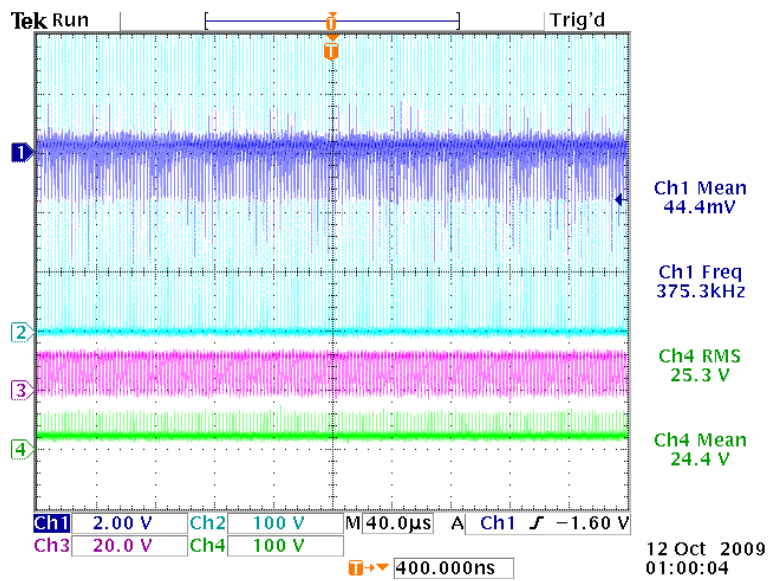

FINISH

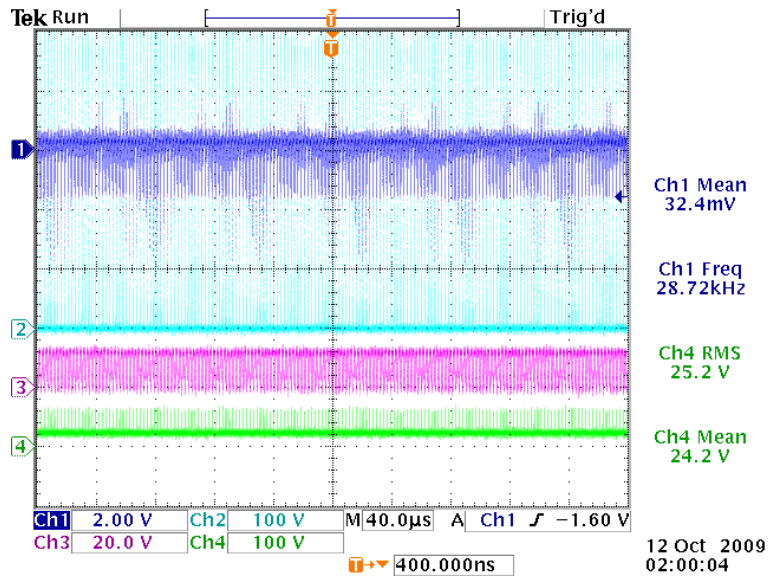

**TEMPERATURE DATA-**

520V-02 SETTINGS  
10-11-09

TEST #5 - "DUPLICATION" / TEST #3  
"HR" "EMIN" Approved By

HR	DIV	IMAGE REF	DATA REF	LOAD 10JL OF	AMBIENT		
1	TIME 20:00	40us	0.PNG	0.CSV	133	73.6	START
	DMM 24.82 V	20us	1.PNG	1.CSV	134	73.8	:15
		2us	2.PNG	2.CSV	136	73.6	:30
					135	73.6	:45
2	TIME 21:00	40us	3.PNG	3.CSV	134	73.4	:00
	DMM 24.73 V	20us	4.PNG	4.CSV	136	73.3	:15
		2us	5.PNG	5.CSV	135	73.3	:30
					134	73.2	:45
3	TIME 22:00	40us	6.PNG	6.CSV	134	73.3	:00
	DMM 24.69 V	20us	7.PNG	7.CSV	134	73.3	:15
		2us	8.PNG	8.CSV	134	73.2	:30
					134	73.2	:45
4	TIME 23:00	40us	9.PNG	9.CSV	133	73.1	:00
	DMM 24.61 V	20us	10.PNG	10.CSV	133	73.1	:15
		2us	11.PNG	11.CSV	132	73.1	:30
					132	73.1	:45
5	TIME 00:00	40us	12.PNG	12.CSV	132	73.2	:00
	DMM 24.57 V	20us	13.PNG	13.CSV	131	73.3	:15
		2us	14.PNG	14.CSV	130	73.1	:30
					130	73.2	:45
6	TIME 01:00	40us	15.PNG	15.CSV	130	73.1	:00
	DMM 24.50 V	20us	16.PNG	16.CSV	130	73.1	:15
		2us	17.PNG	17.CSV	130	72.9	:30
					131	73.1	:45
*	"FINISH"	40us	18.PNG	18.CSV	130	73.2	:00
	TIME 02:00	20us	19.PNG	19.CSV			
	DMM 24.45 V	2us	20.PNG	20.CSV			

ADDED WAVE FORMS -

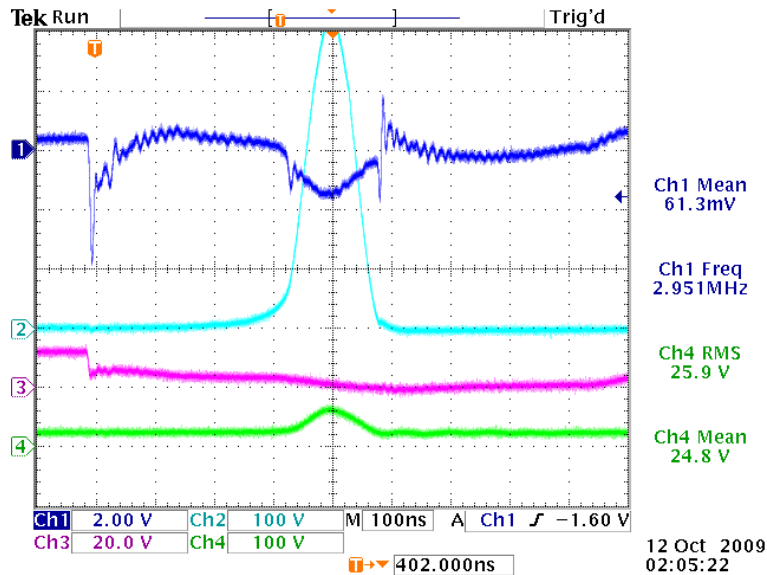

[Glen's Rosemary Ainslie COP>17 Heater Circuit – DATA TEST #5](#)

**Rosemary Ainslie COP>17 Heater Circuit - TEST #6**

I did a short test on the Rosemary Ainslie COP>17 Heater Circuit with a standard store bought 10 ohm 100 watt ( "MEMCOR" # FR100 ) load resistor, and after a short time the results were not as expected. The best arrangement for added gains in this circuit is to have the Mosfet source or Channel 1 to be the lowest mV as possible 30 to 70 is ideal but anything over 100 mV gains in circuit efficiency lowers.

The "load resistor" temperature was higher but so was the consumption of battery energy loosing .3 Volts every hour on my Fluke 87 DMM connection.

**40us**

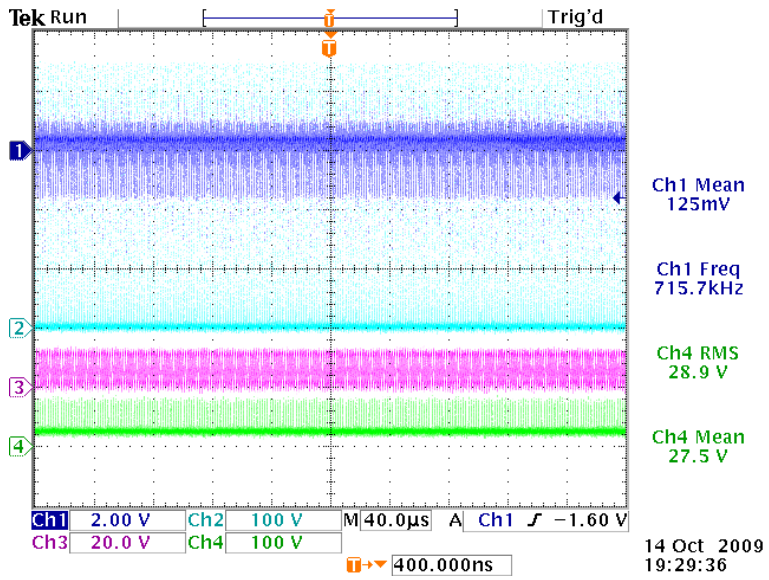

20us

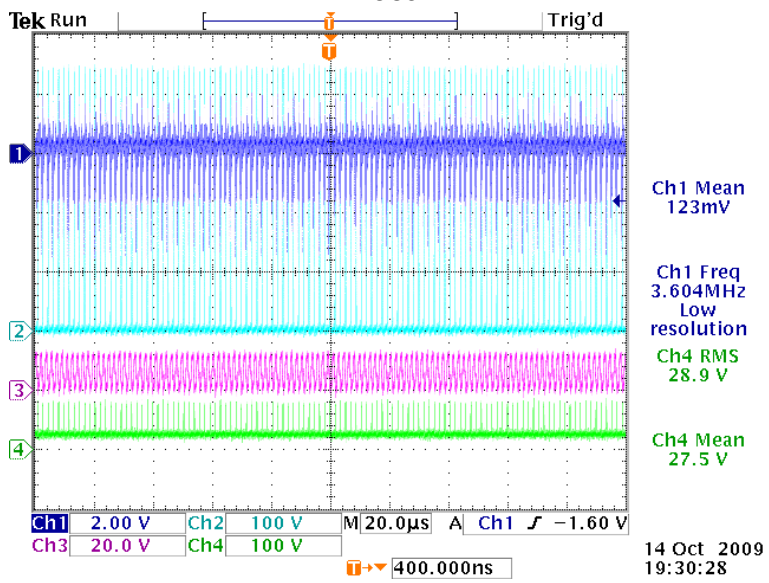

2us

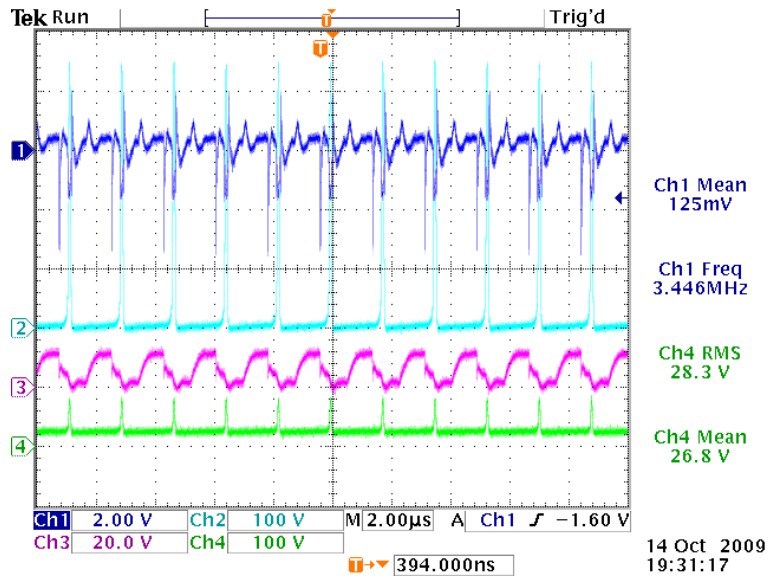

10ms

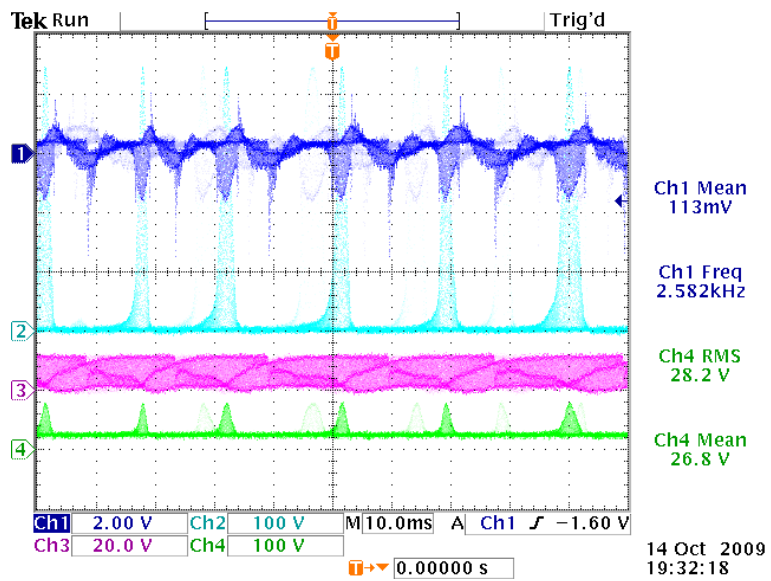

100ns

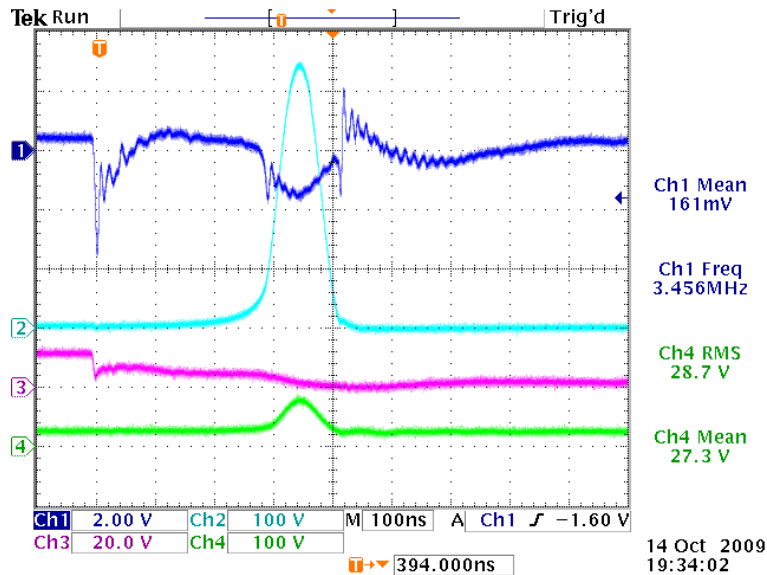

All Images and data from a Tektronix TDS 3054C from the Tektronix Corporation

[Glen's Rosemary Ainslie COP>17 Heater Circuit – DATA TEST #6](#)

### Rosemary Ainslie COP>17 Heater Circuit - TEST #7

Here is some data from a test run using a new 10 ohm Mosfet gate potentiometer to try to bring a better percentage accuracy to the required 5.8 to 5.3 ohms that seems to make this circuit run much more efficient. The test although a very short one was stopped for a good reason when the circuit seemed to self osculate and the Mosfet "drain" voltage went above 610 Volts and the battery's were spiking at around 98 Volts, I immediately terminated the test run because of possible damage to the equipment.

And the results were interesting to say the least and the final Image and Data dump on the 100ns had gains that hasn't ever been seen before, and if possible to maintain these values would be incredible.

This test was using the same components as TEST #3 and #5 with my prototype "Quantum" 10 ohm load resistor.

- Channel 1 - Mosfet source shunt
- Channel 2 - Mosfet drain
- Channel 3 - 555 Timer pin #3
- Channel 4 - 24 VDC "Liquid" Lead Acid Battery Bank

10ms

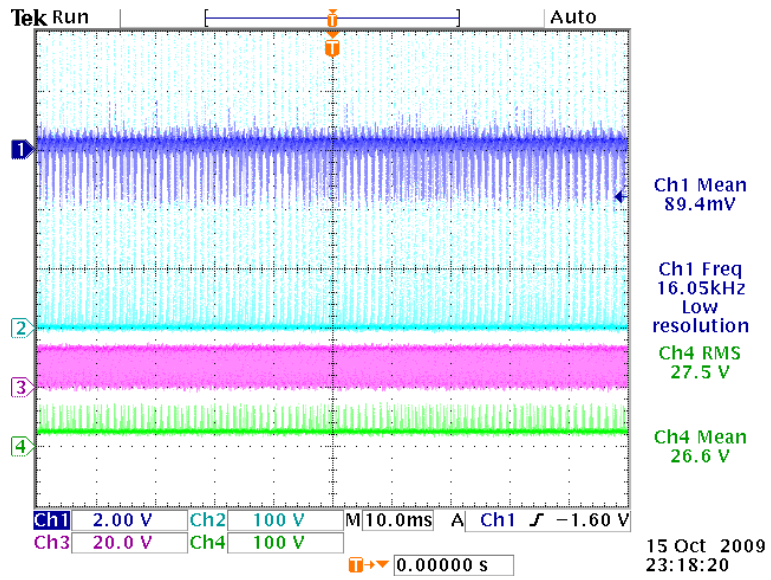

40us

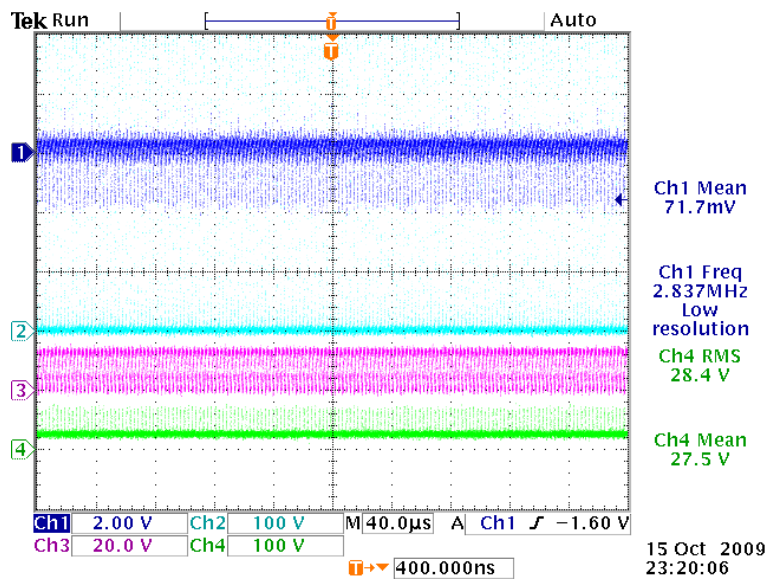

20us



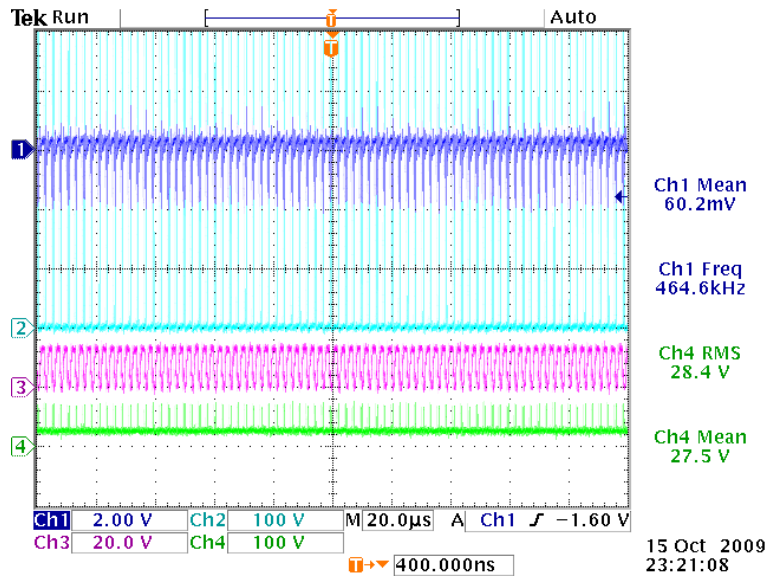

2µs

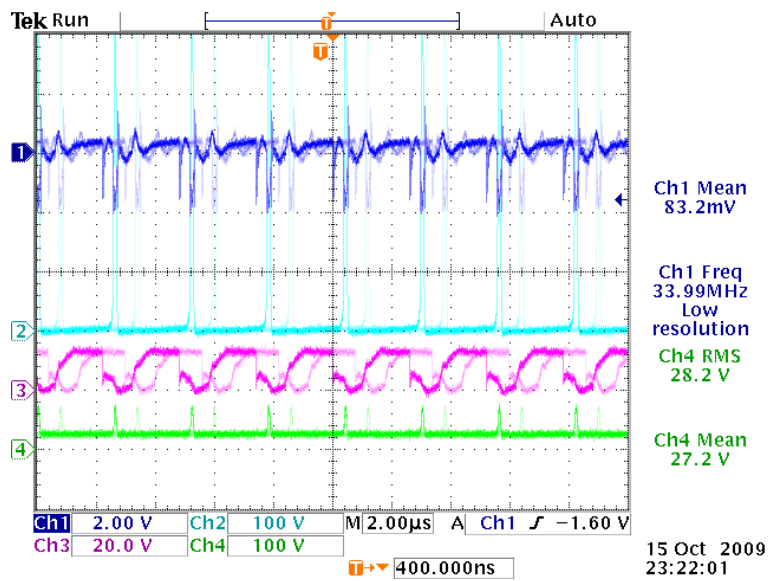

100ns

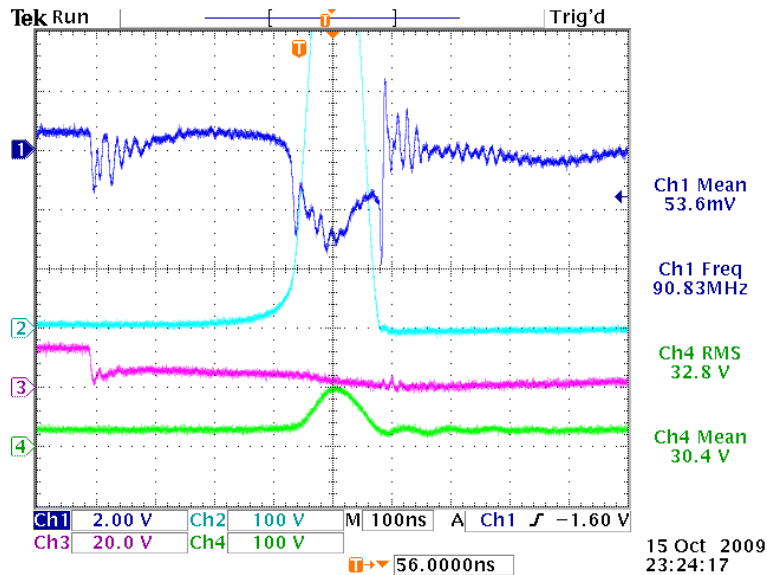

[Glen's Rosemary Ainslie COP>17 Heater Circuit – DATA TEST #7](#)

**TEST #8 "Clean Up" and "Mosfet Shunt"**

Here is a short test after doing some recommended "Device Under Test" (DUT) circuit modifications....

- 1) Prototype "Load Resistor" - remove circuit alligator test clips and connect with crimp-on wire ring terminals
- 2) Mosfet Source Pin - remove 3" wire extension wire for probe connection, probe now connected to Mosfet "source" pin
- 3) Battery Probe Connection - relocated to the common probe ground terminal connection point, Probe tip now twelve (12) inches from prototype "Load Resistor"

Channel 1 - Mosfet source shunt  
 Channel 2 - Mosfet drain  
 Channel 3 - 555 Timer pin #3  
 Channel 4 - 24 VDC "Liquid" Lead Acid Battery Bank

1\_40us

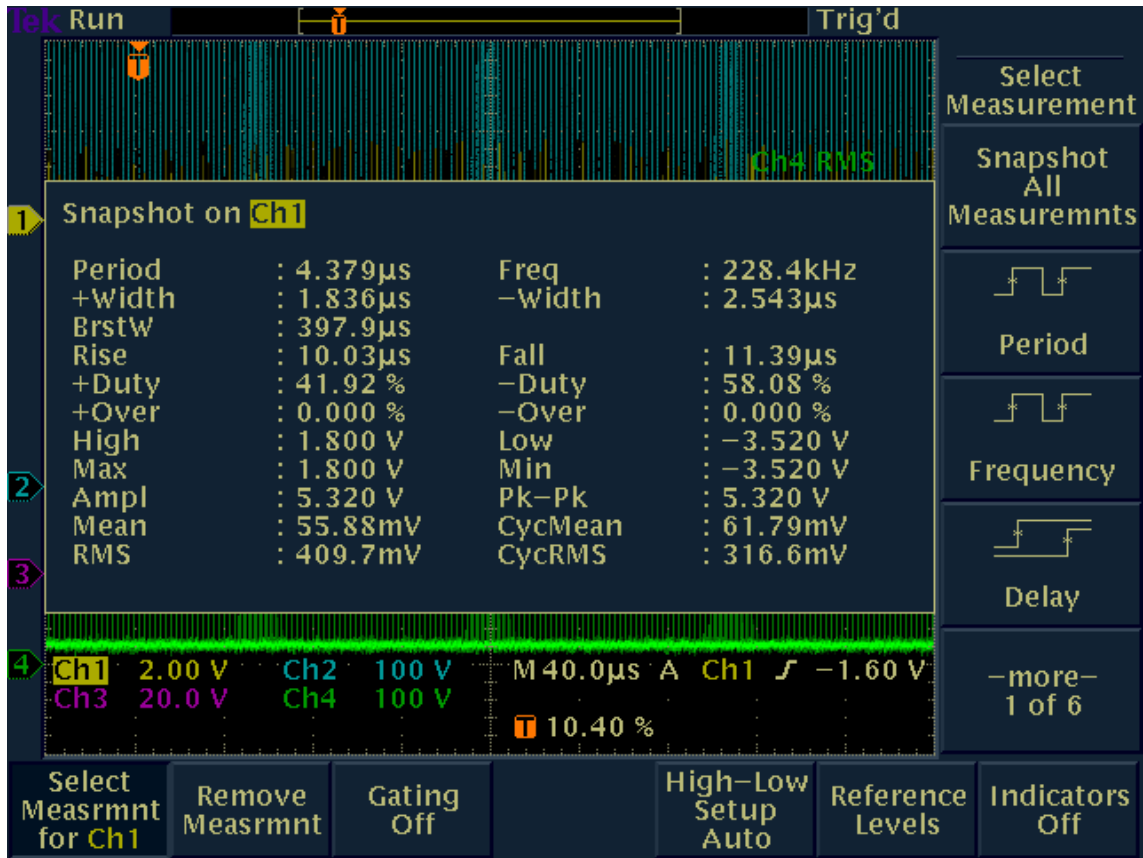

"Snapshot with Math Functions"

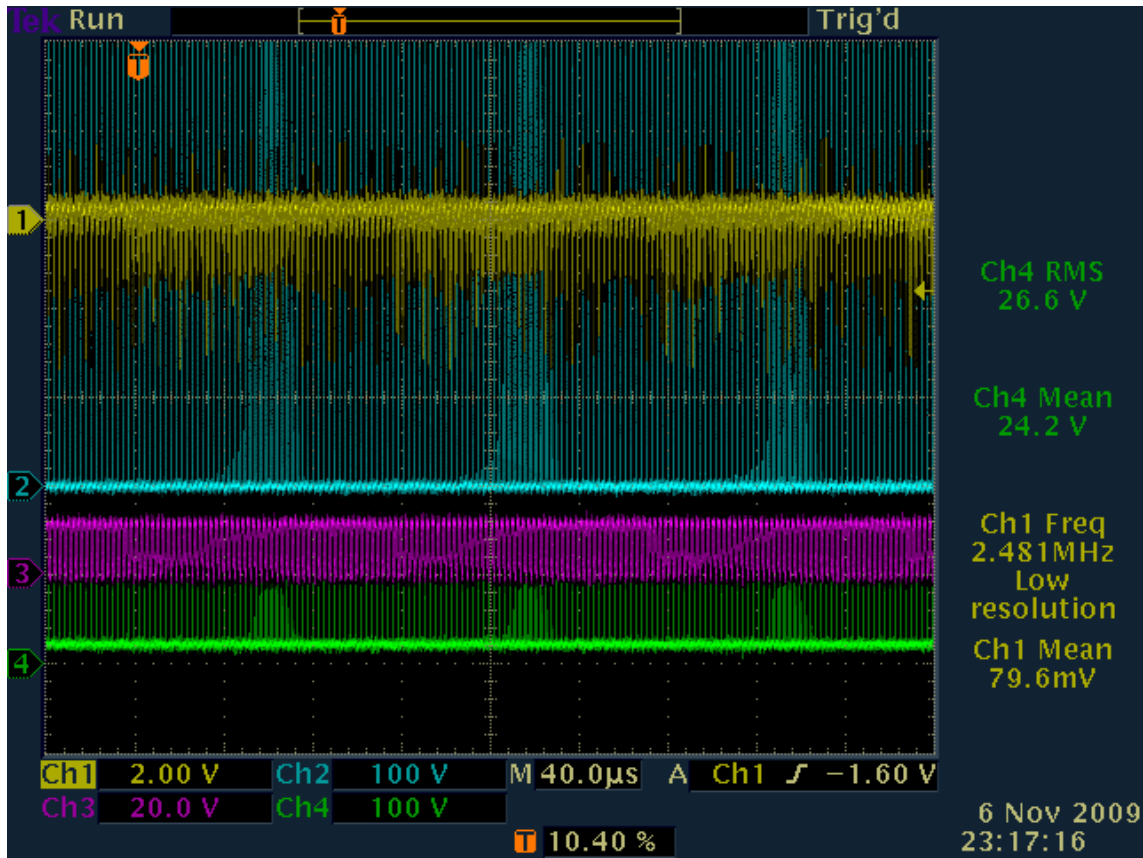

2\_40us

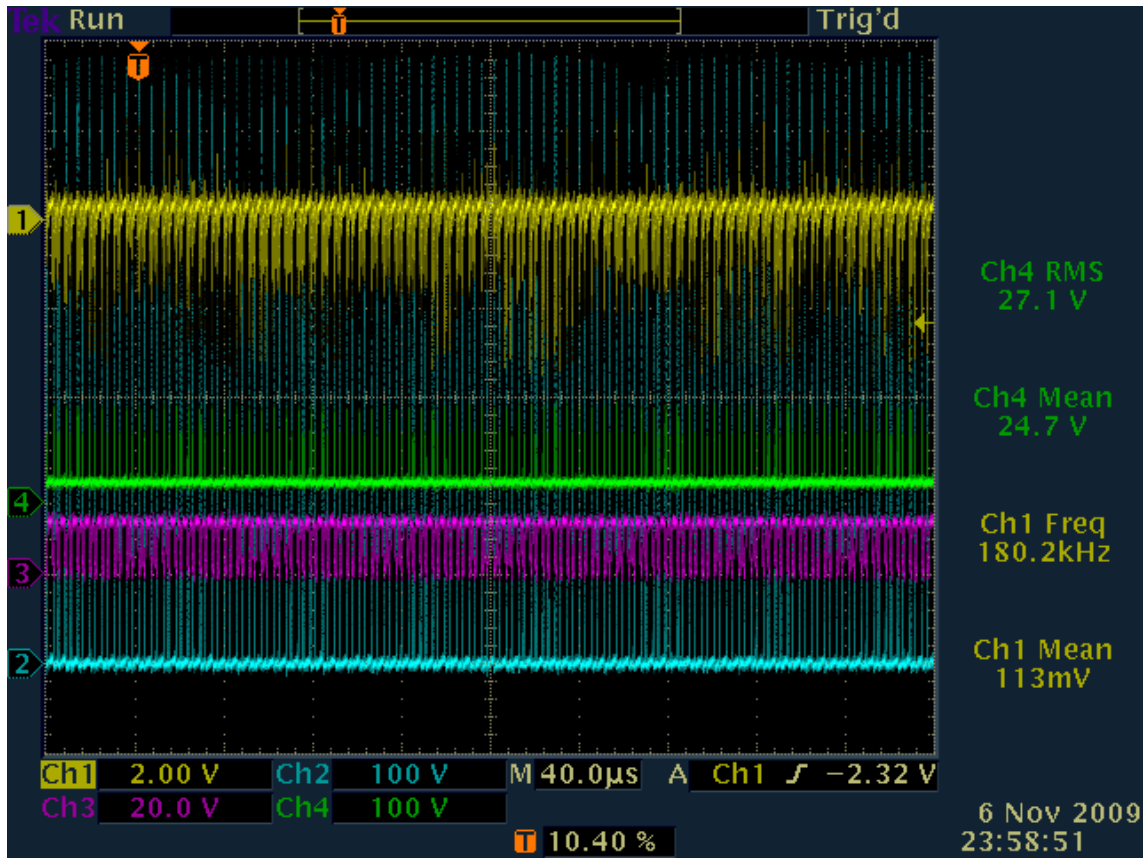

1\_100ns

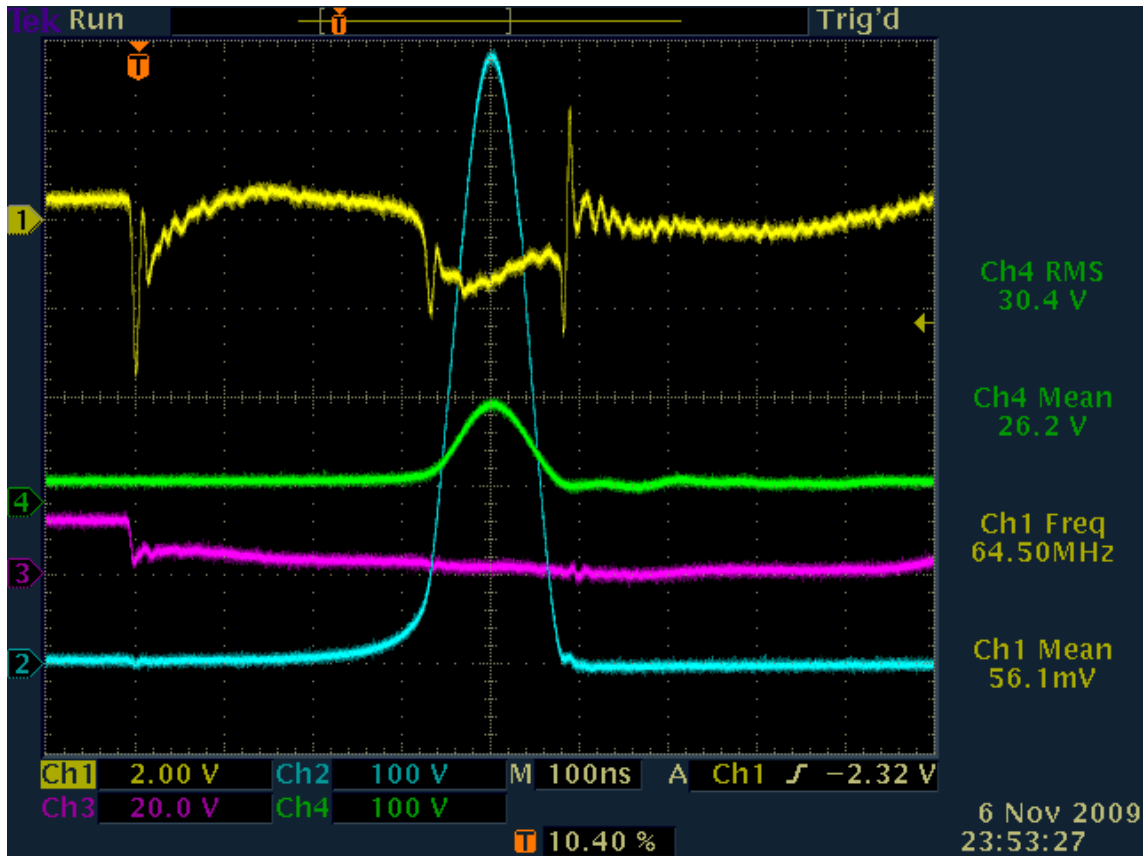

This is a test using only two oscilloscope probes with one probe tip on Channel-1 between the Mosfet and Shunt and Channel-2 between the Shunt and the Battery Negative (B-) terminal.

Both probe grounds Channel-1 and Channel-2 connected to a separate isolated AC ground point "NOT" to the battery negative (B-) terminal

- Channel 1 - Mosfet Source to Shunt
- Channel 2 - Shunt to Battery Negative
- Channel 3 - 555 Timer Pin #3 (no probe connection - reference only)

MOSFET\_SHUNT\_BAT-N\_555

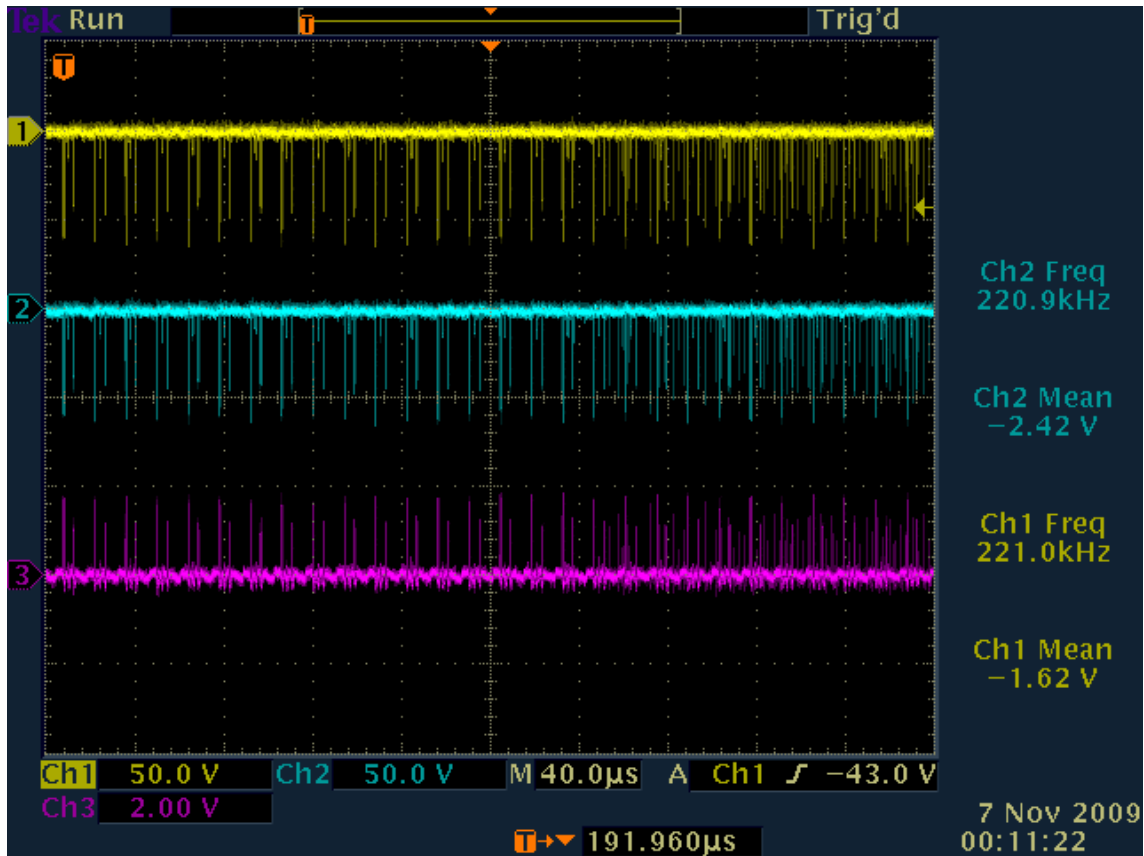

All Images and data from a Tektronix TDS 3054C from the Tektronix Corporation

[TEST #9 - New Shunt & Re-test of TEST #8](#)

I just received my replacement 0.25 ohm "shunt" resistor [Caddock High Performance Film Resistors](#) it's a "non-inductive" 30 watt type [MP930-0.25-1%](#), I am in the process of removing the wire wound type ["Dale" RS-2B .25 ohm 3 watt 3 %](#) that was use on all testing numbers 1 through 8 .

[Designing With Caddock MP Series TO-Style Heat Sink Mountable Power Film Resistors](#)

Here is Test #9 with the new shunt a 0.25 Ohm resistor from "Caddock" High Performance Film Resistor, "non-inductive" 30 Watt, type [MP930-0.25-1%](#), this is a re-test of [TEST #8](#)

\*The TDS 3054C oscilloscope probes are a type Tektronix P6139A with the standard 6" grounding leads.

**Channel 1 - Mosfet source shunt**  
**Channel 2 - Mosfet drain**

Channel 3 - 555 Timer pin #3  
 Channel 4 - 24 VDC "Liquid" Lead Acid Battery Bank

Channel-3\_555\_SNAPSHOT

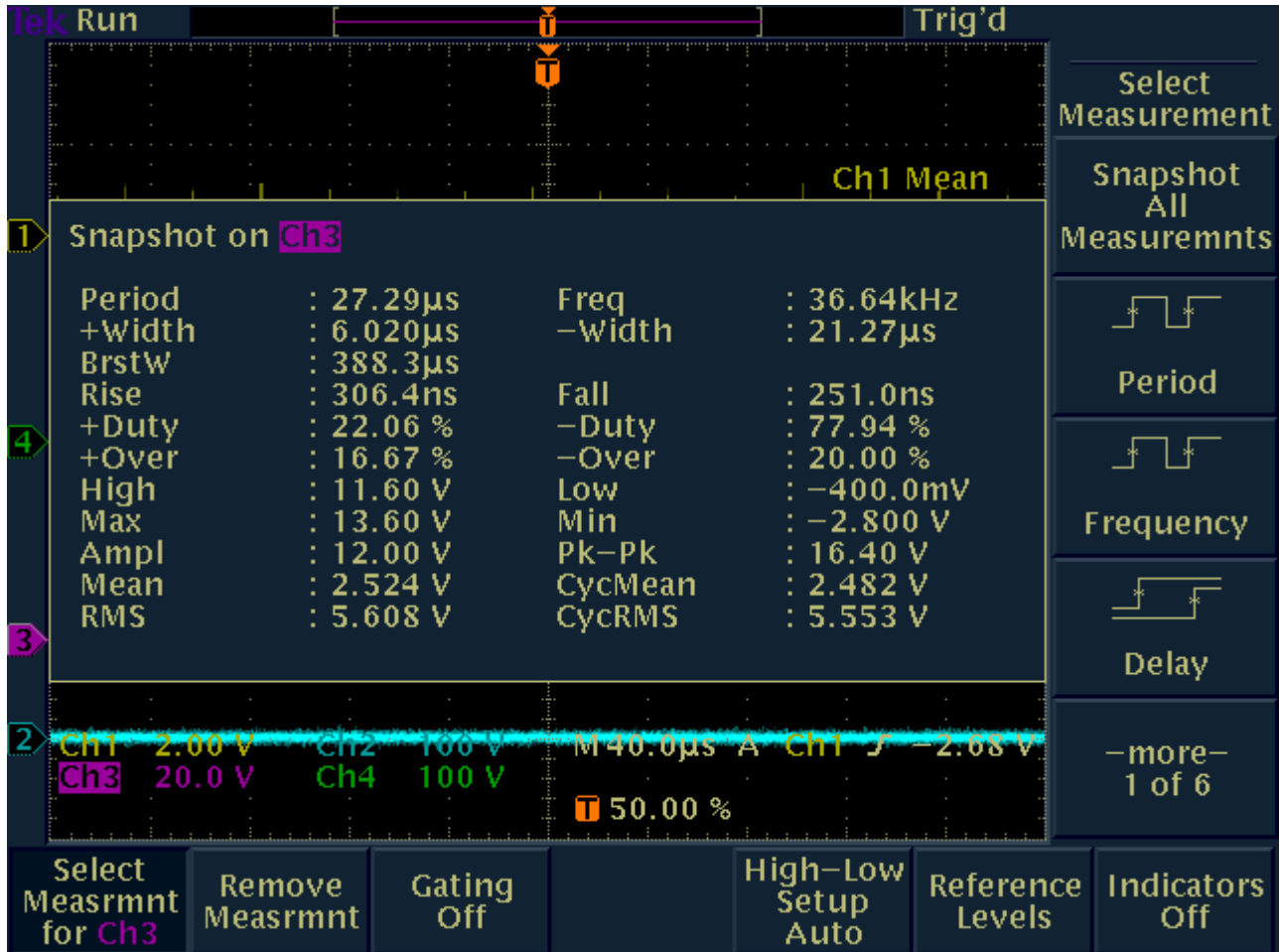

( 555 Image Readings Taken Prior to 24 Volt Battery Connection )

40us\_11-13-09



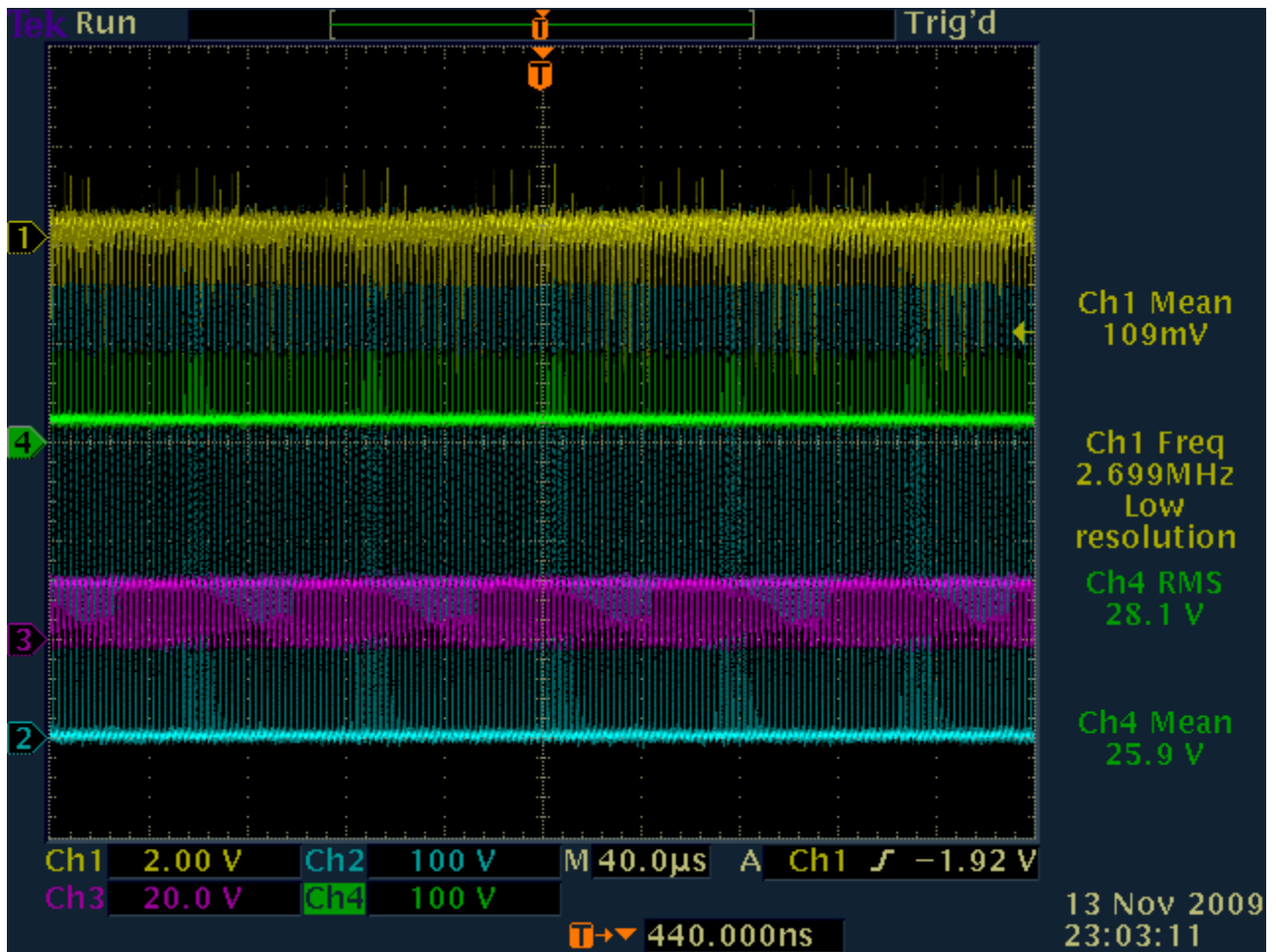

20us\_11-13-09

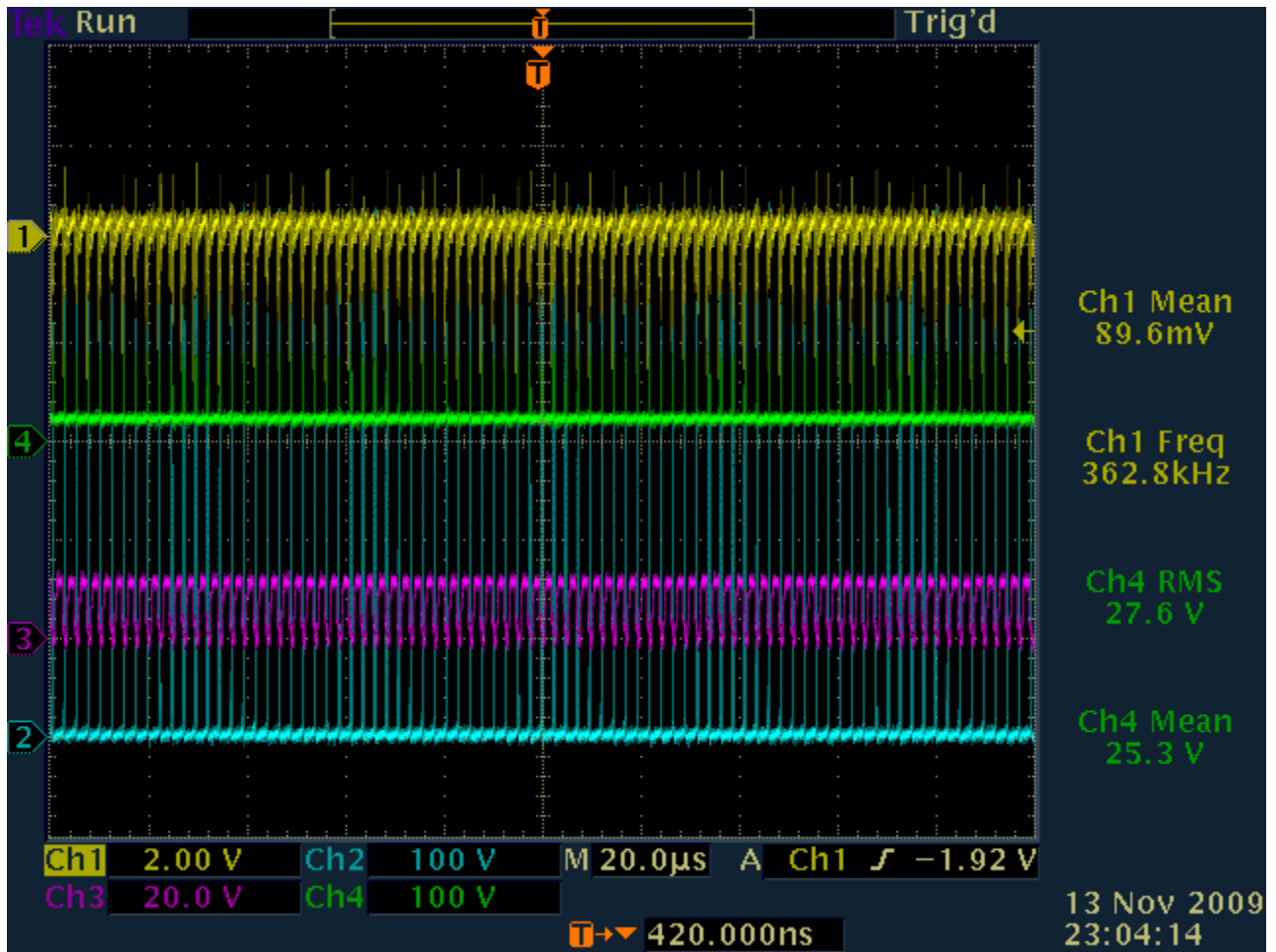

2us\_11-13-09

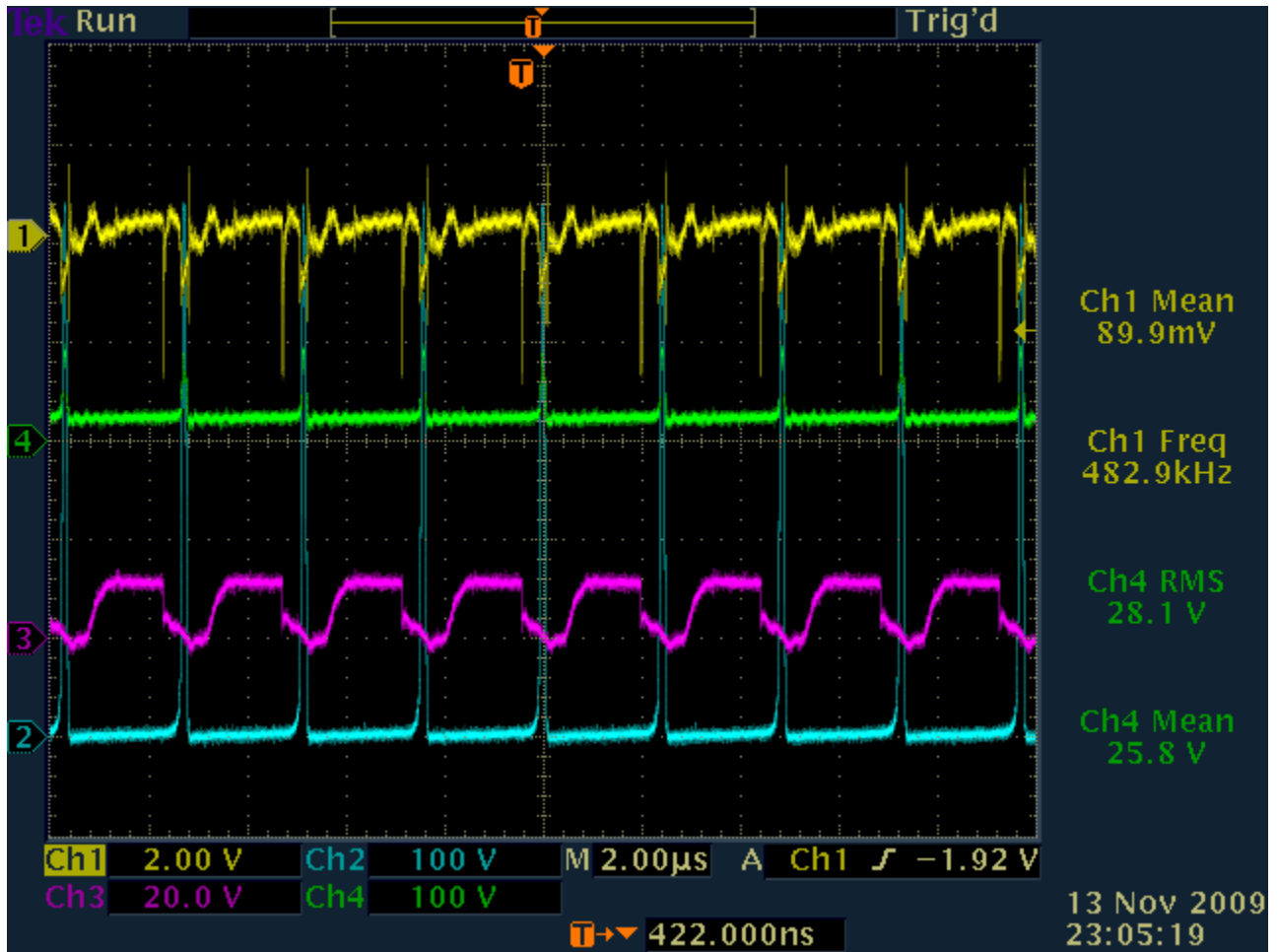

1us\_11-13-09

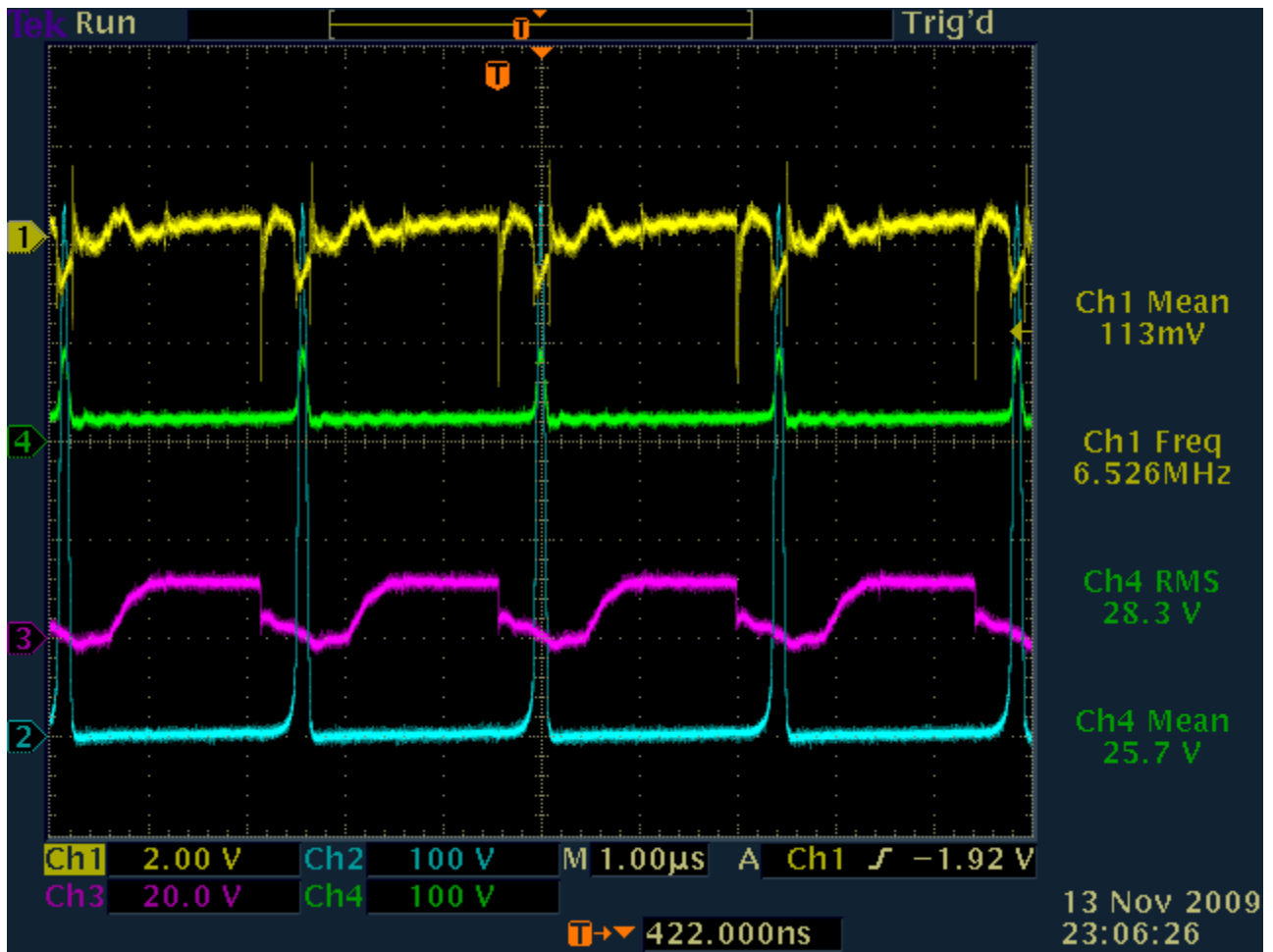

100ns\_11-13-09

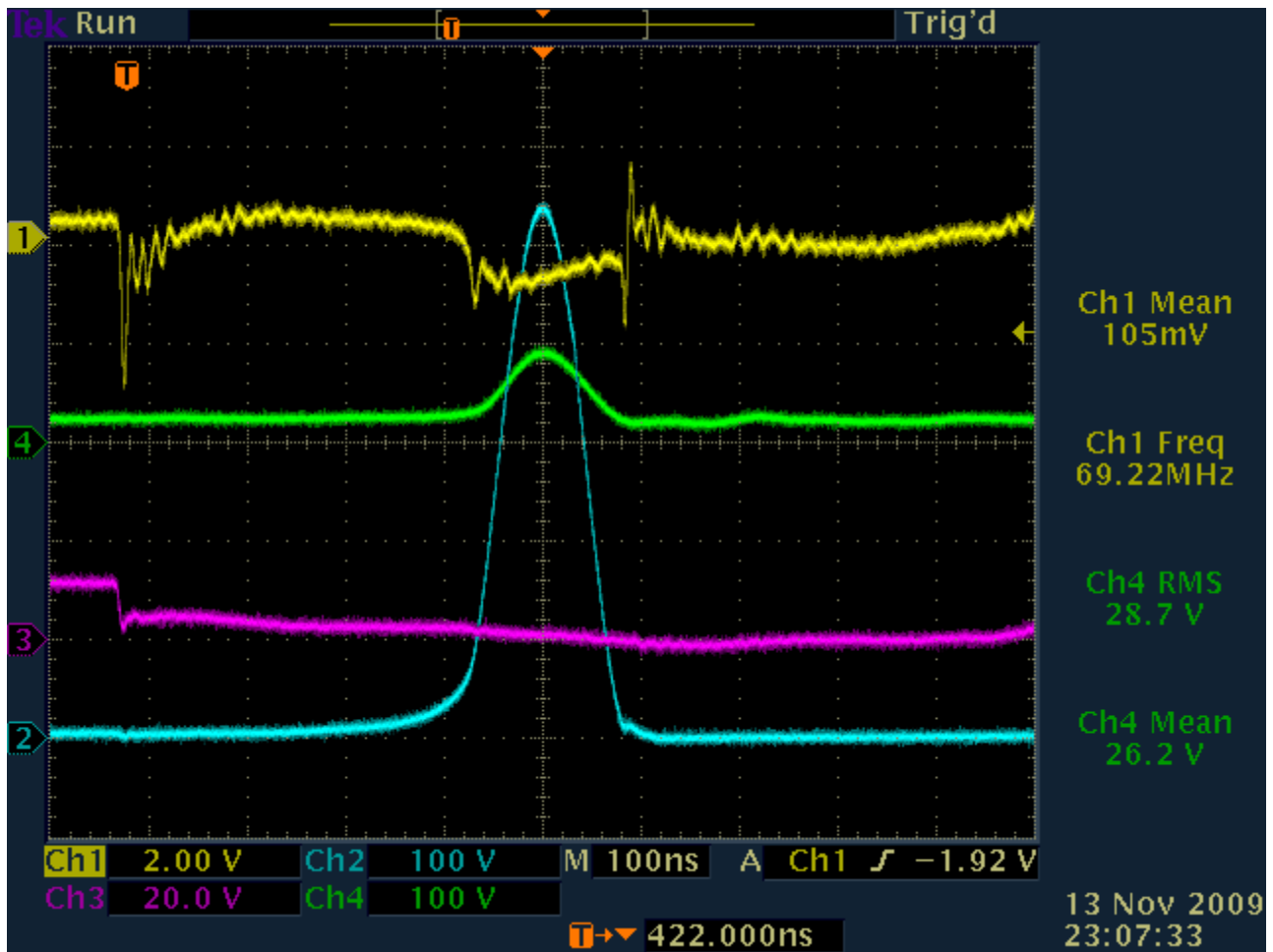

This is a test using only two oscilloscope probes with one probe tip on Channel-1 between the Mosfet and Shunt and Channel-2 between the Shunt and the Battery Negative (B-) terminal.

Both probe grounds Channel-1 and Channel-2 connected to a separate isolated AC ground point "NOT" to the battery negative (B-) terminal

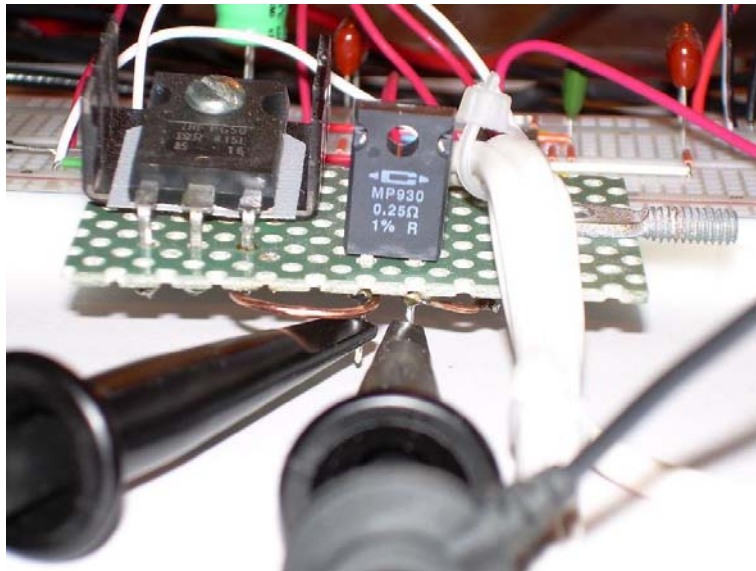

**Channel 1 - Mosfet Source to Shunt**  
**Channel 2 - Shunt to Battery Negative**  
**Channel 3 - 555 Timer Pin #3 (no probe connection - reference only)**

**MOSFET\_SHUNT\_BAT\_N\_555\_11-13-09**

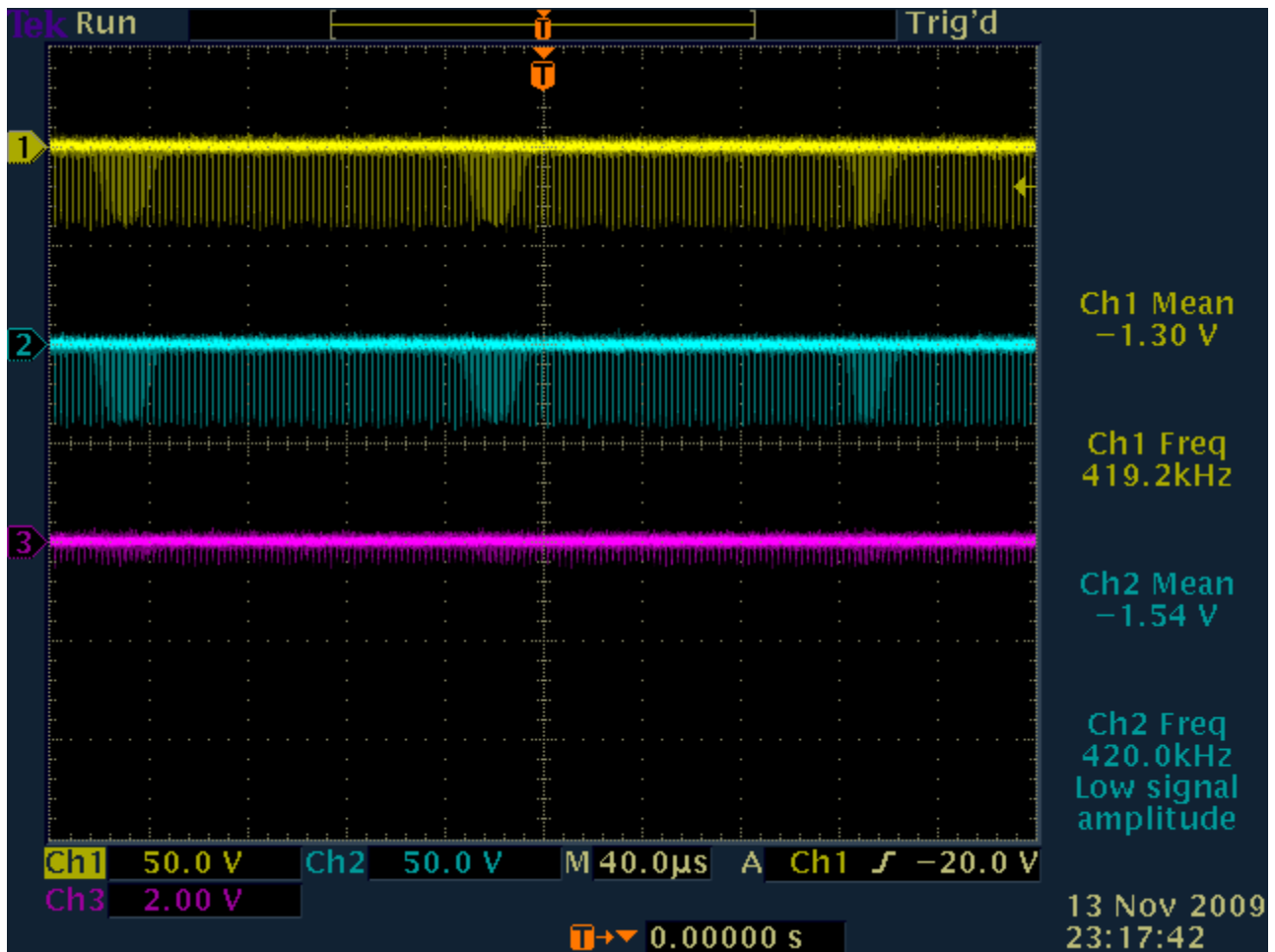

All Images and data by a Tektronix TDS 3054C from the Tektronix Corporation

[Glen\\_Tests/Test9\\_\(Spatial\\_Test\\_-\\_B\).zip](#)

Here is TEST #10 it's a one (1) hour test with 40us and 2us readings taken every six (6) minutes for a total of eleven (11) readings or twenty two (22) Image and Data files for one (1) hour.

[Rosemary Ainslie COP>17 Heater Circuit  
"Quantum" October 2002](#)

**Replication Components -**

- 1) [International Rectifier - IRFPG50 HEXFET® Power MOSFET](#)  
w/ Sil-Pad insulator between Mosfet and Heat Sink
- 2) [Fairchild Semiconductor - NE555N Timer](#)

- 3) [Vishay Spectrol - SP534 Percision Potentiometer/ 10-turn 2-Watt](#)
- 4) [Exide Technologies Battery "Liquid Lead Acid" Model # GT-H - TRACTOR 12V 12Ah CCA 235](#)
- 5) CSB Battery Company "Gel Lead Acid" #GP 1270 F2 / 12 Volt 7.0 Ah
- 6) Prototype "Quantum" Load Resister 10 ohm + - 1%
- 7) "Shunt" - Caddock High Performance Film Resistor "non-inductive" 30 watt type [MP930-0.25-1%](#)

**Temperature Measurements -**

Fluke 62 "mini" IR Themometer ( used maximum reading on each componenet )

**Digital Mulit Meter -**

Fluke 87 DMM true RMS

**Channel 1 - Mosfet source shunt**

**Channel 2 - Mosfet drain**

**Channel 3 - 555 Timer pin #3**

**Channel 4 - 24 VDC "Liquid" Lead Acid Battery Bank**

[TEST #10 Complete Original Image & Data .Zip File Set w/ Key](#)

**SNAP SHOT CHANNEL-1 40us**



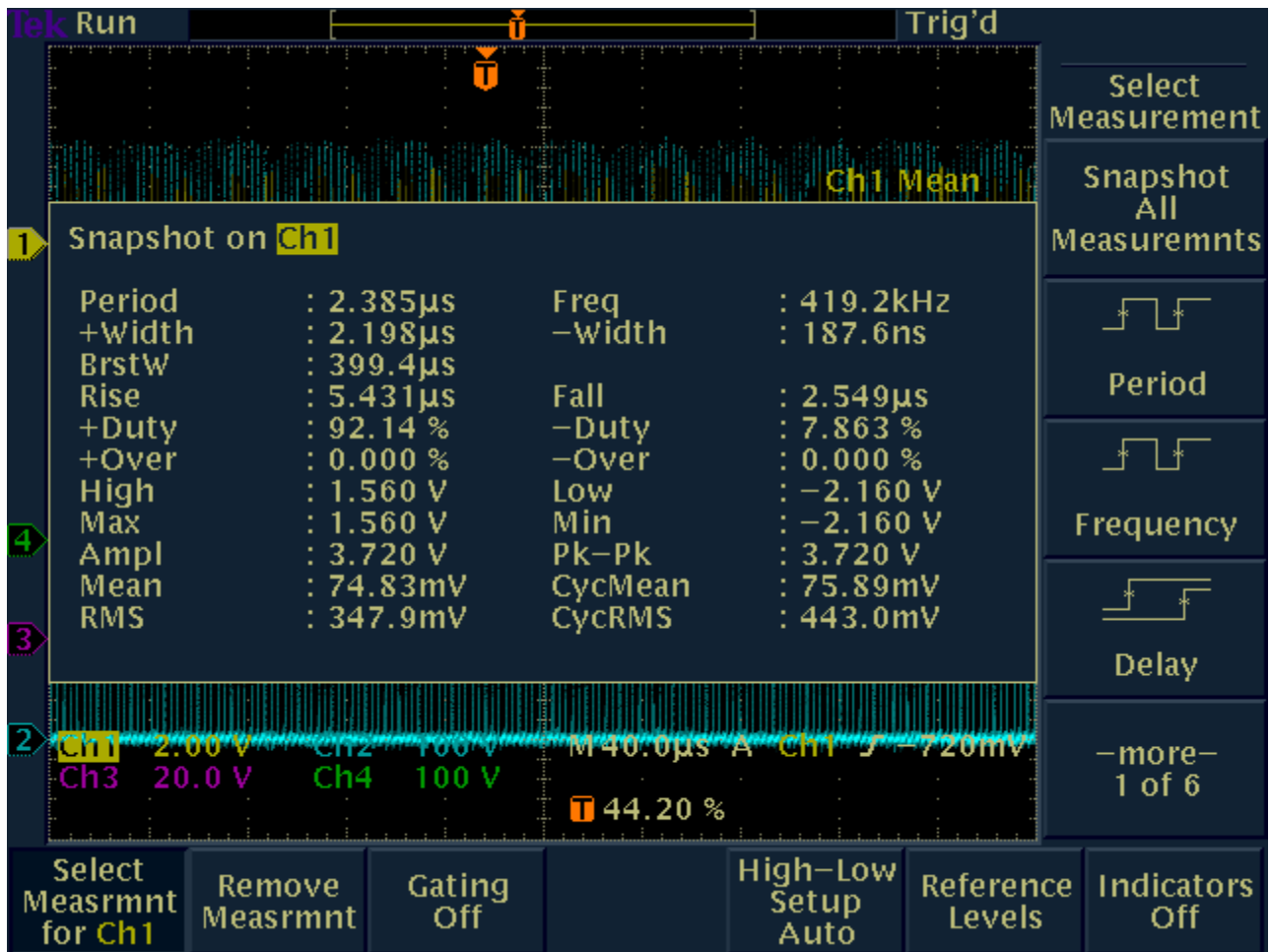

1\_40us

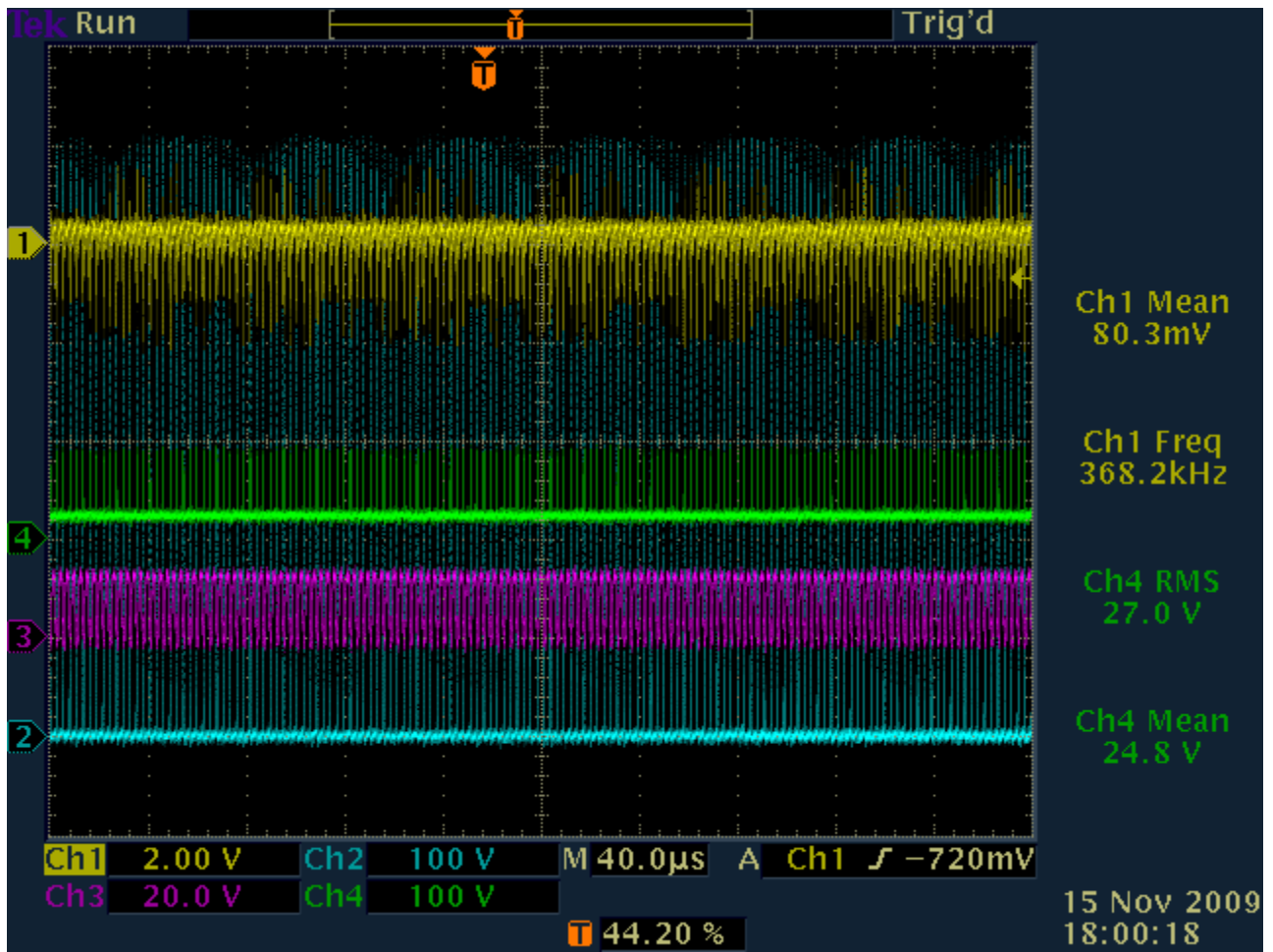

1\_2us

2\_40us

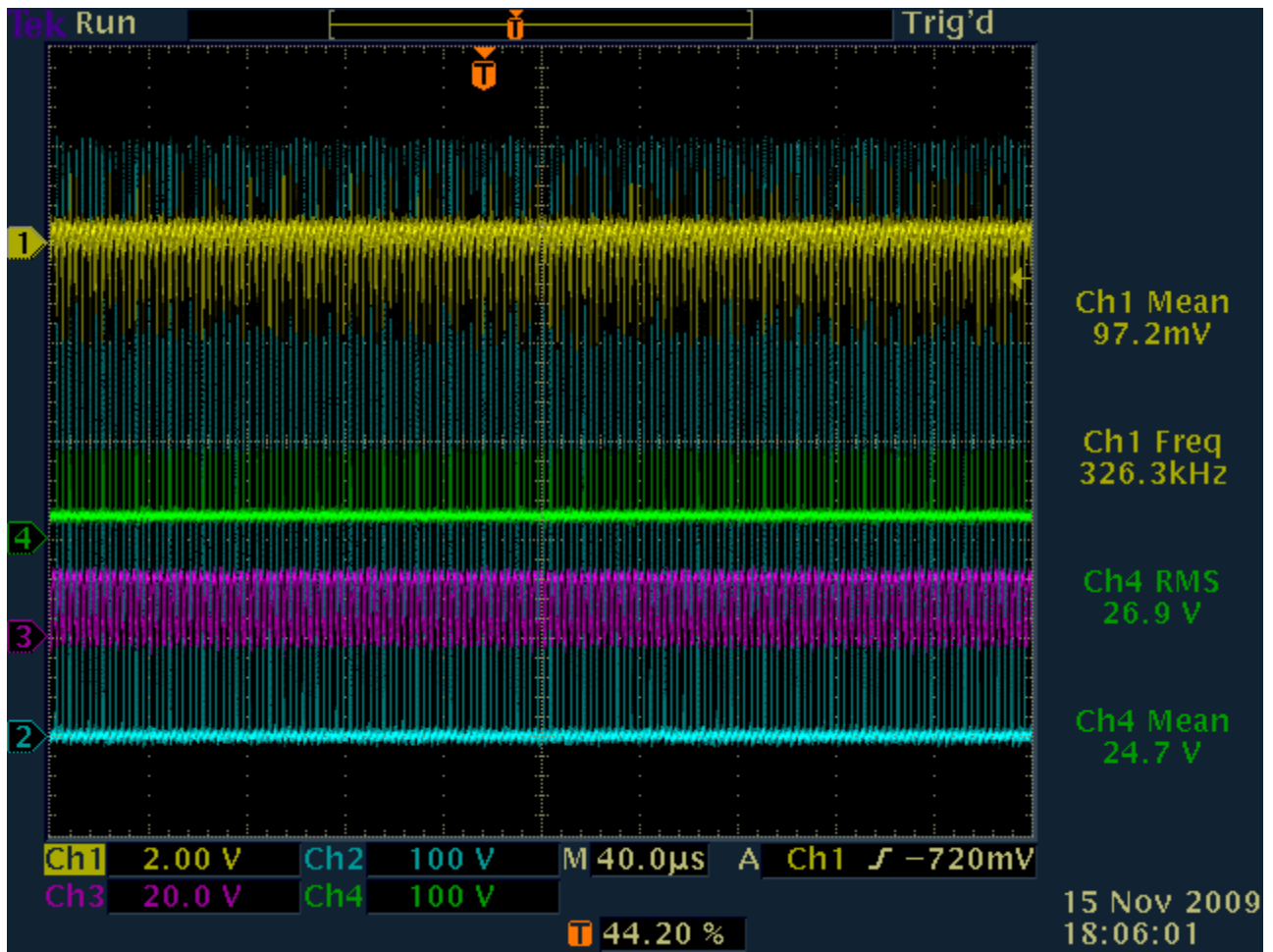

2\_2us

3\_40us

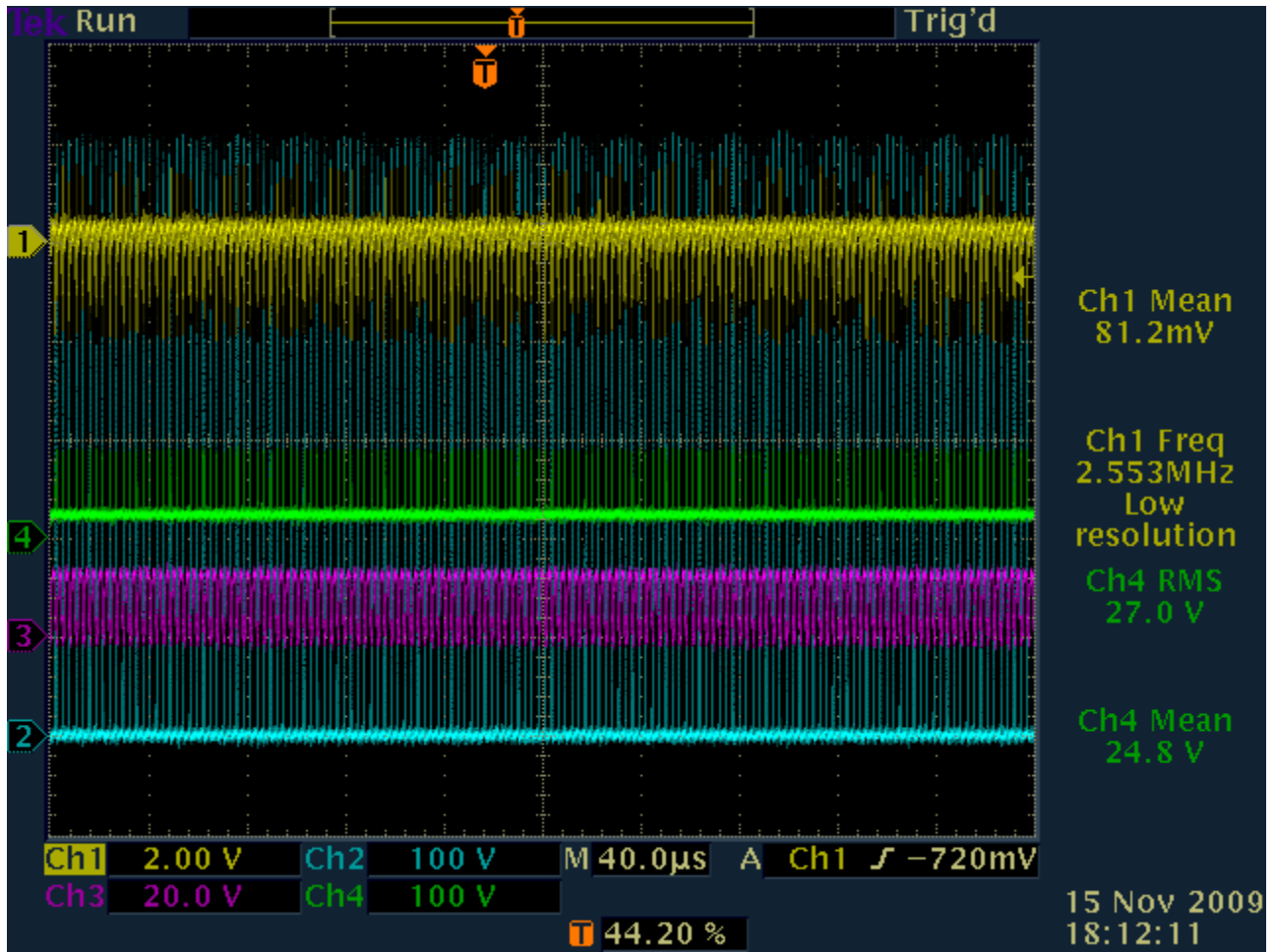

3\_2us

4\_40us

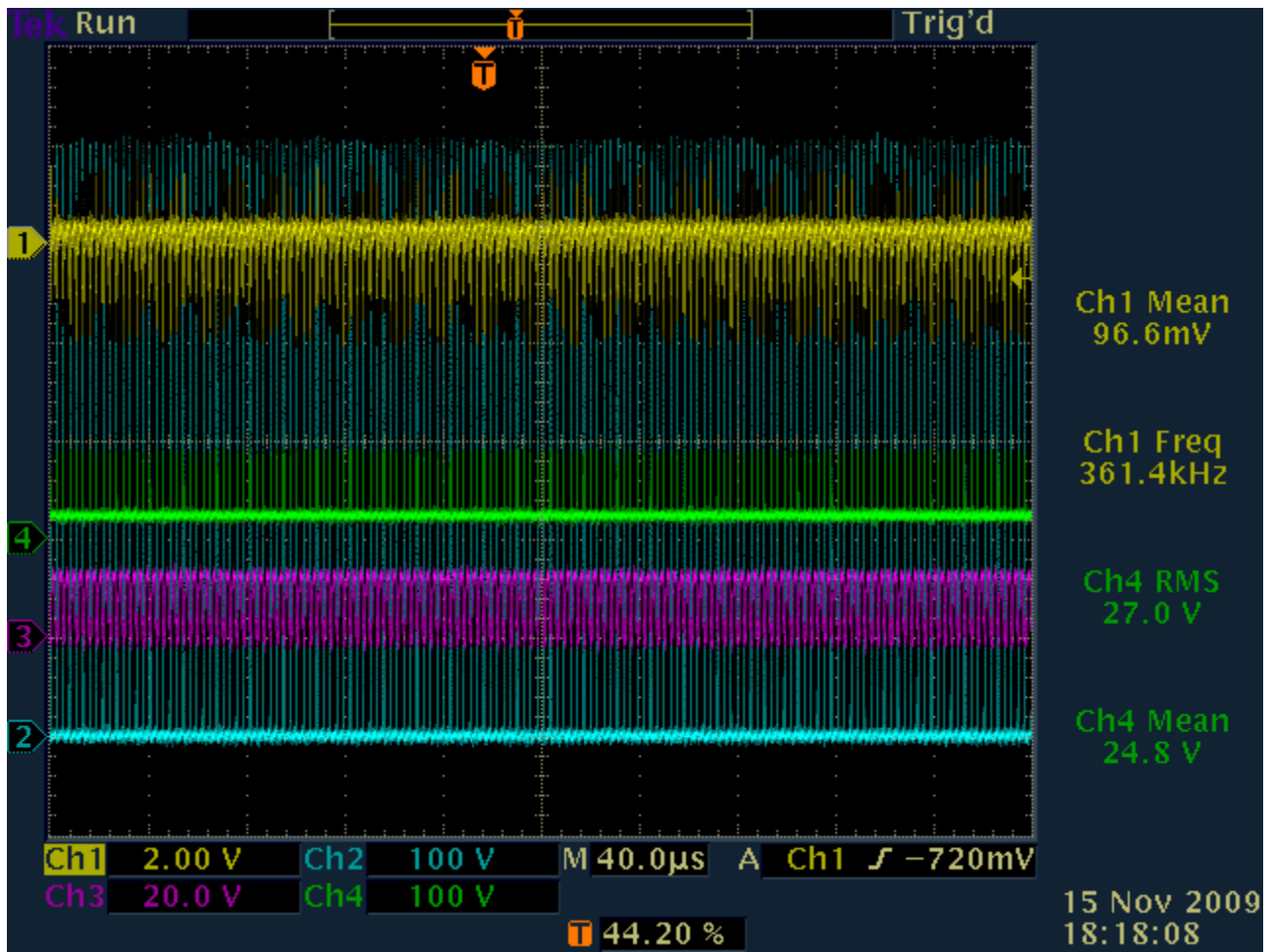

4\_2us

5\_40us

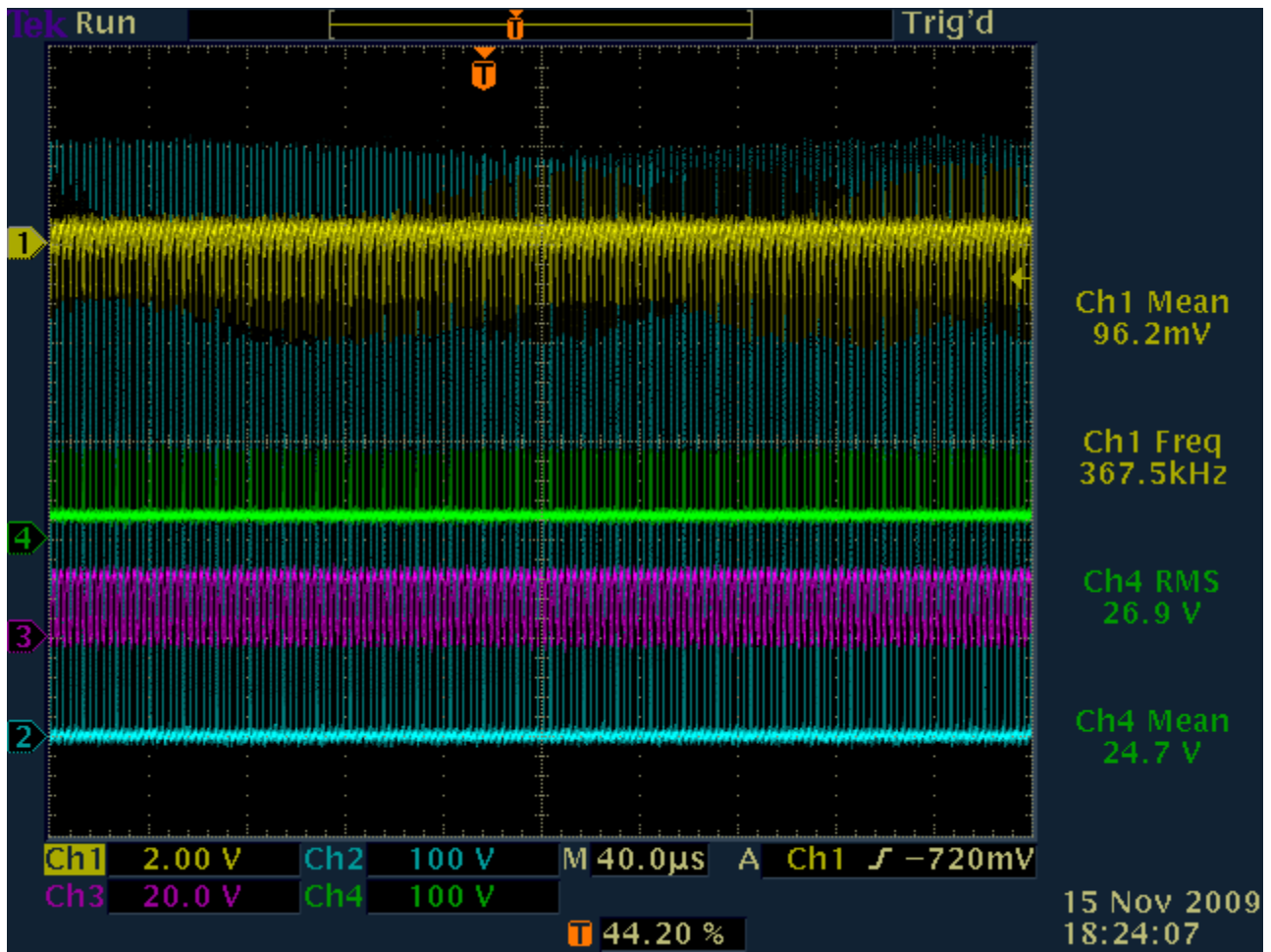

5\_2us

6\_20us

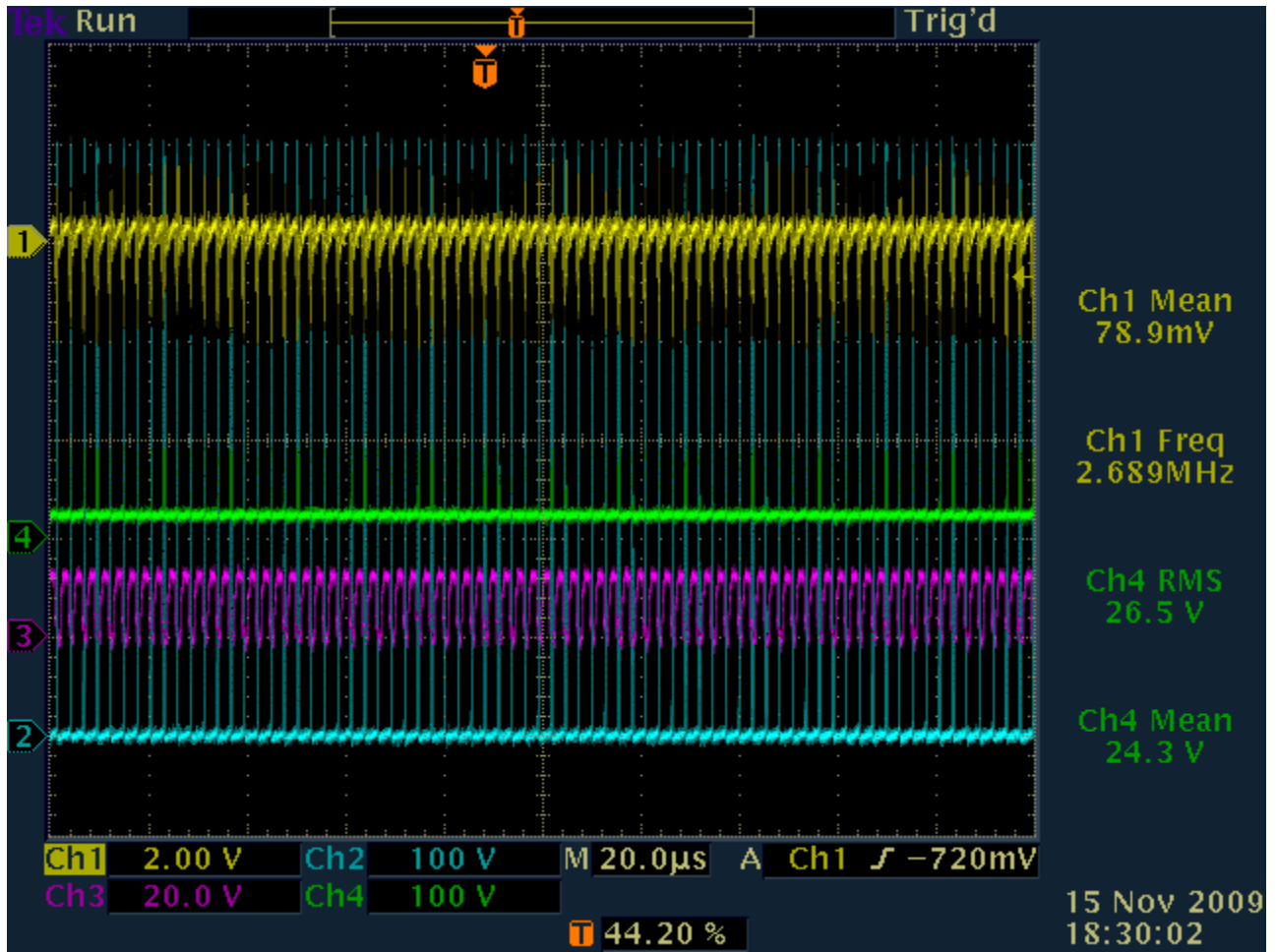

6\_2us

7\_40us

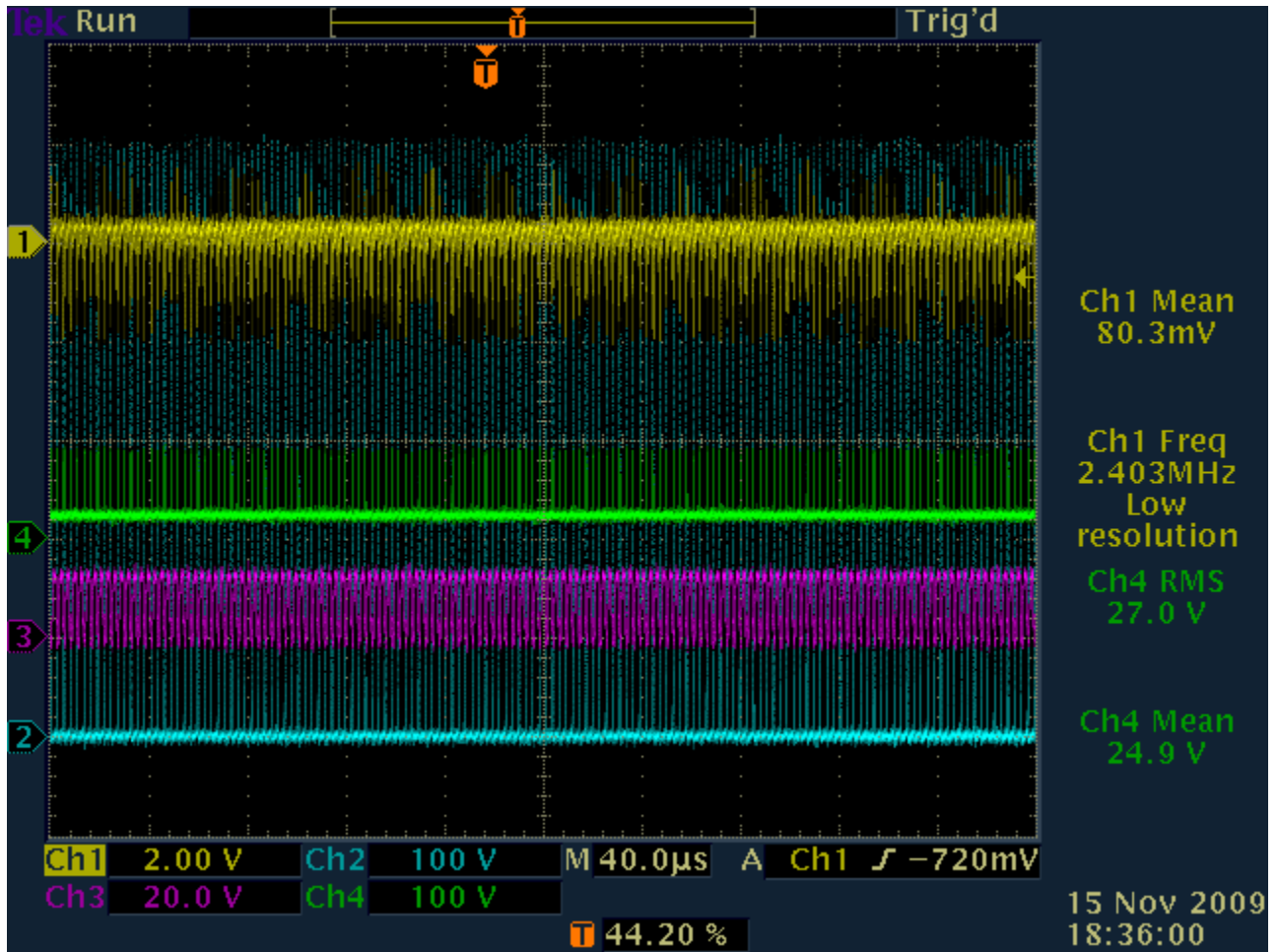

7\_2us

8\_40us



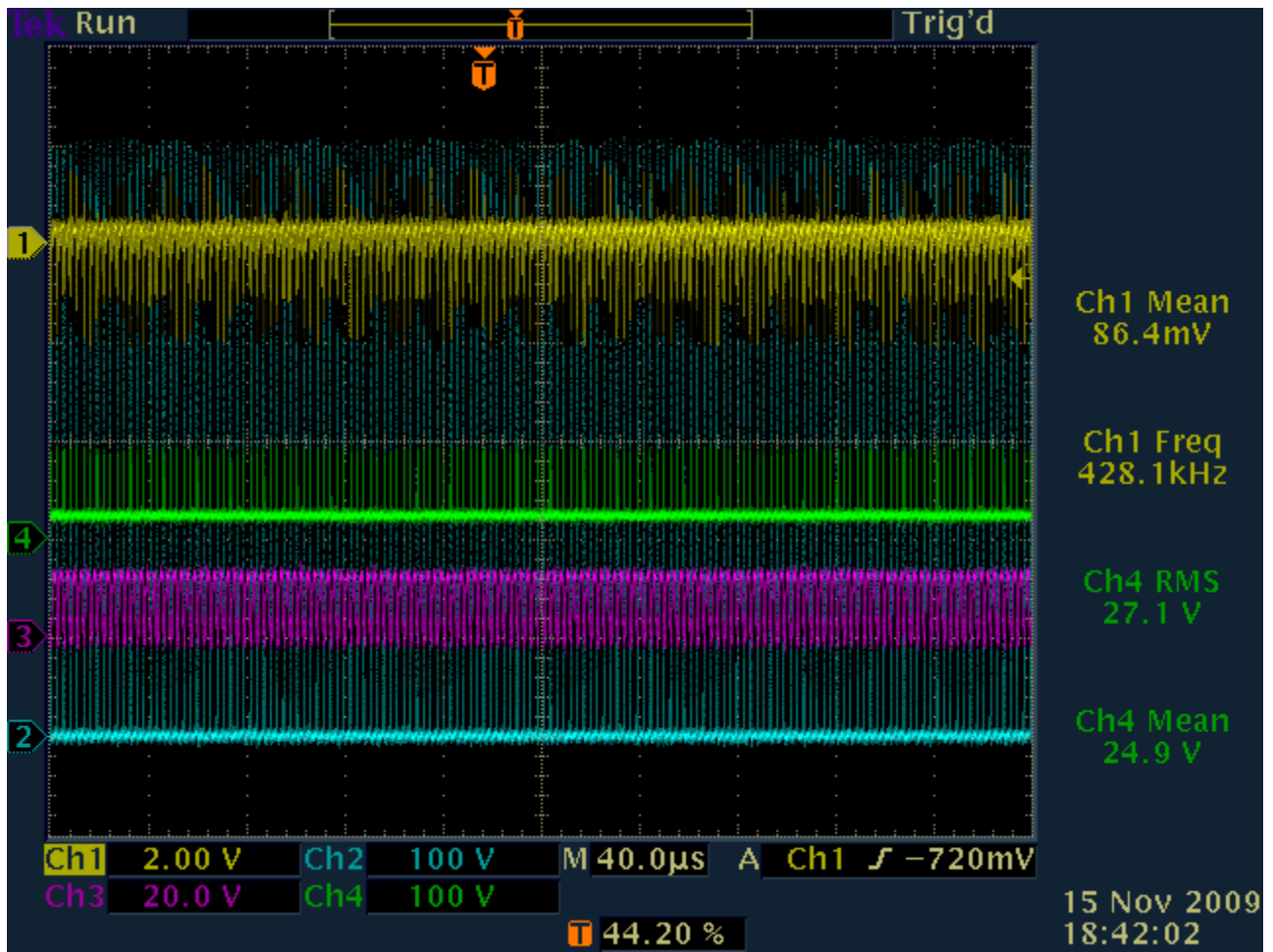

8\_2us

9\_40us

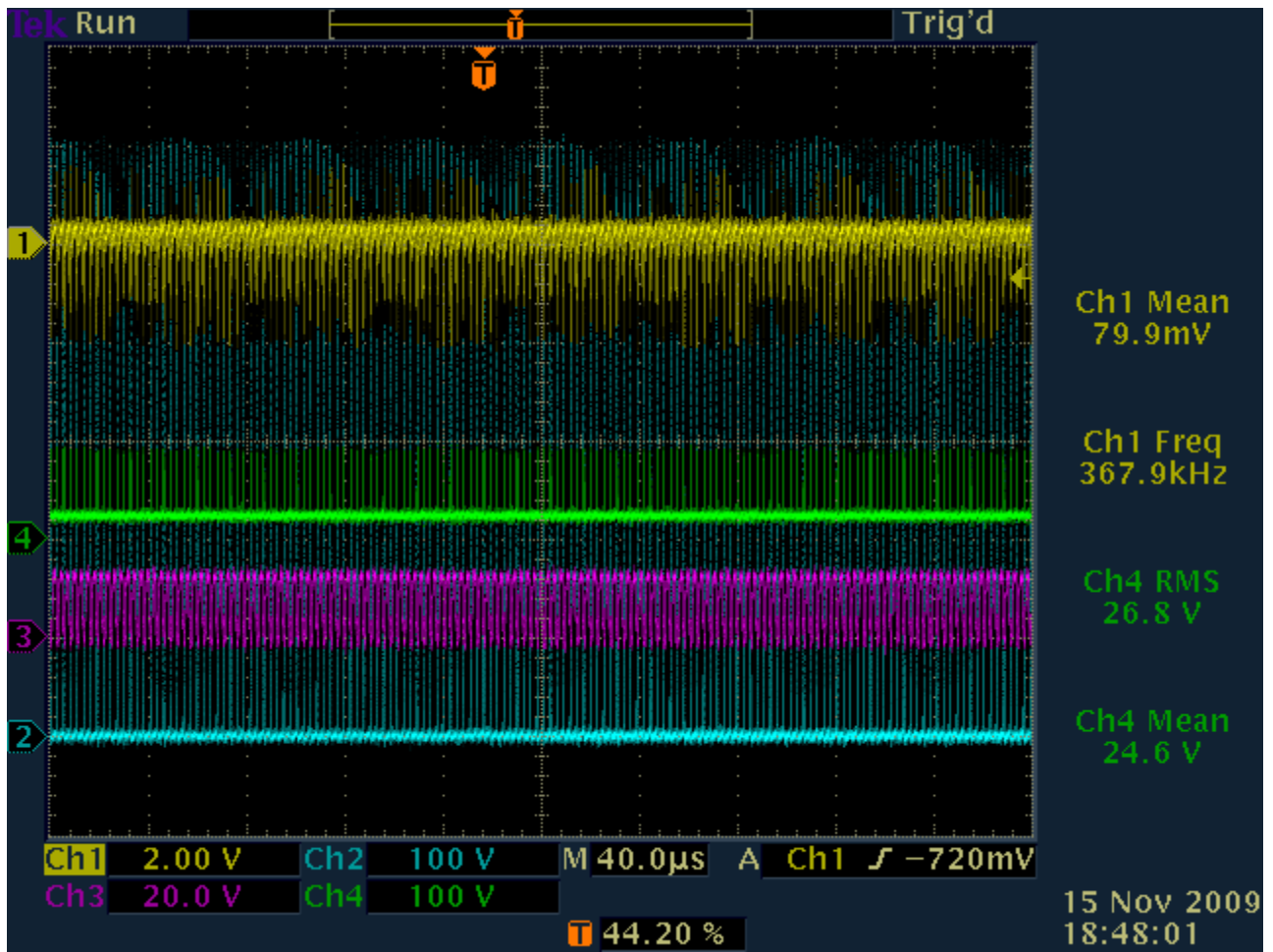

9\_2us

10\_40us

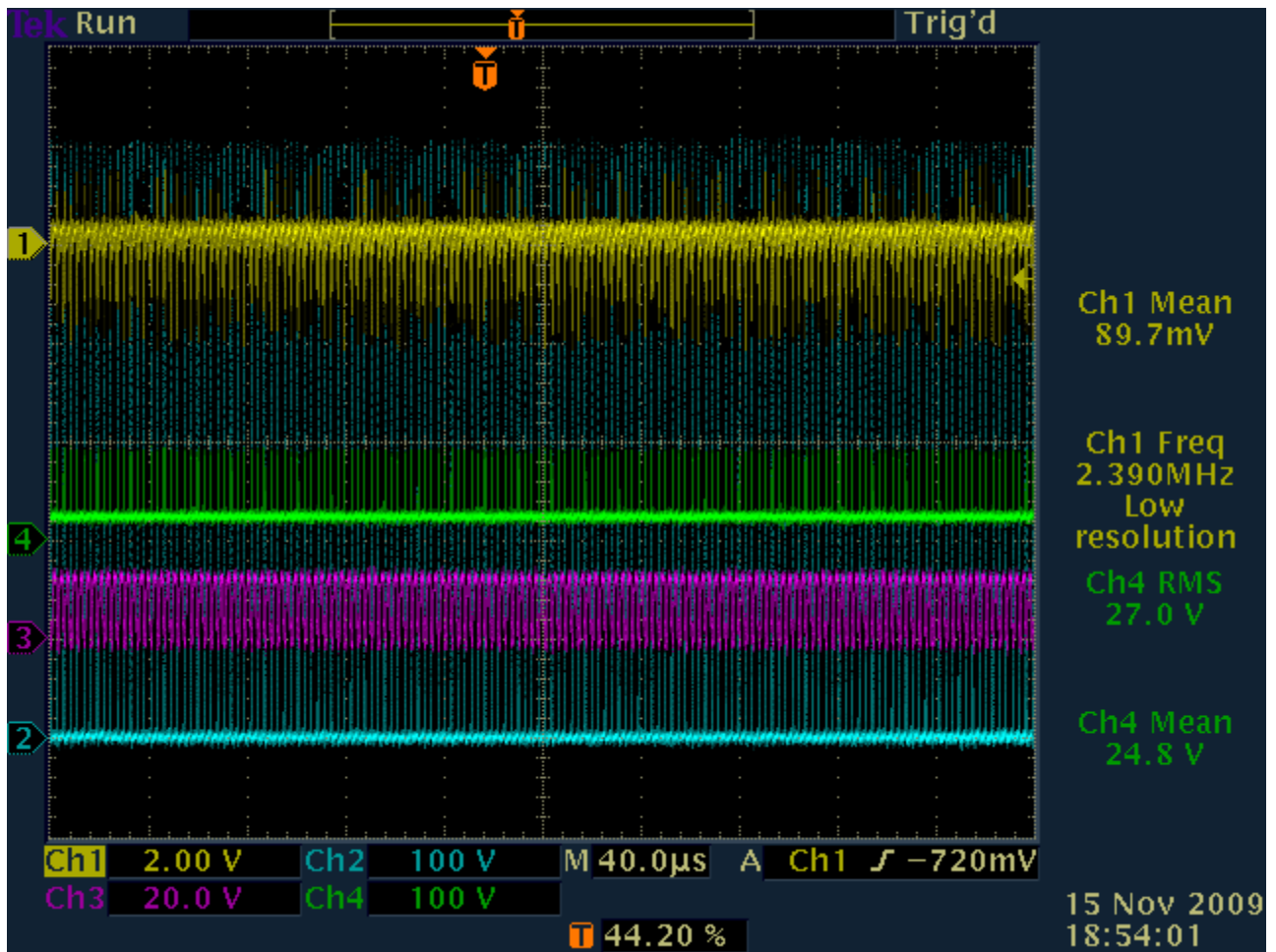

10\_2us

11\_40us

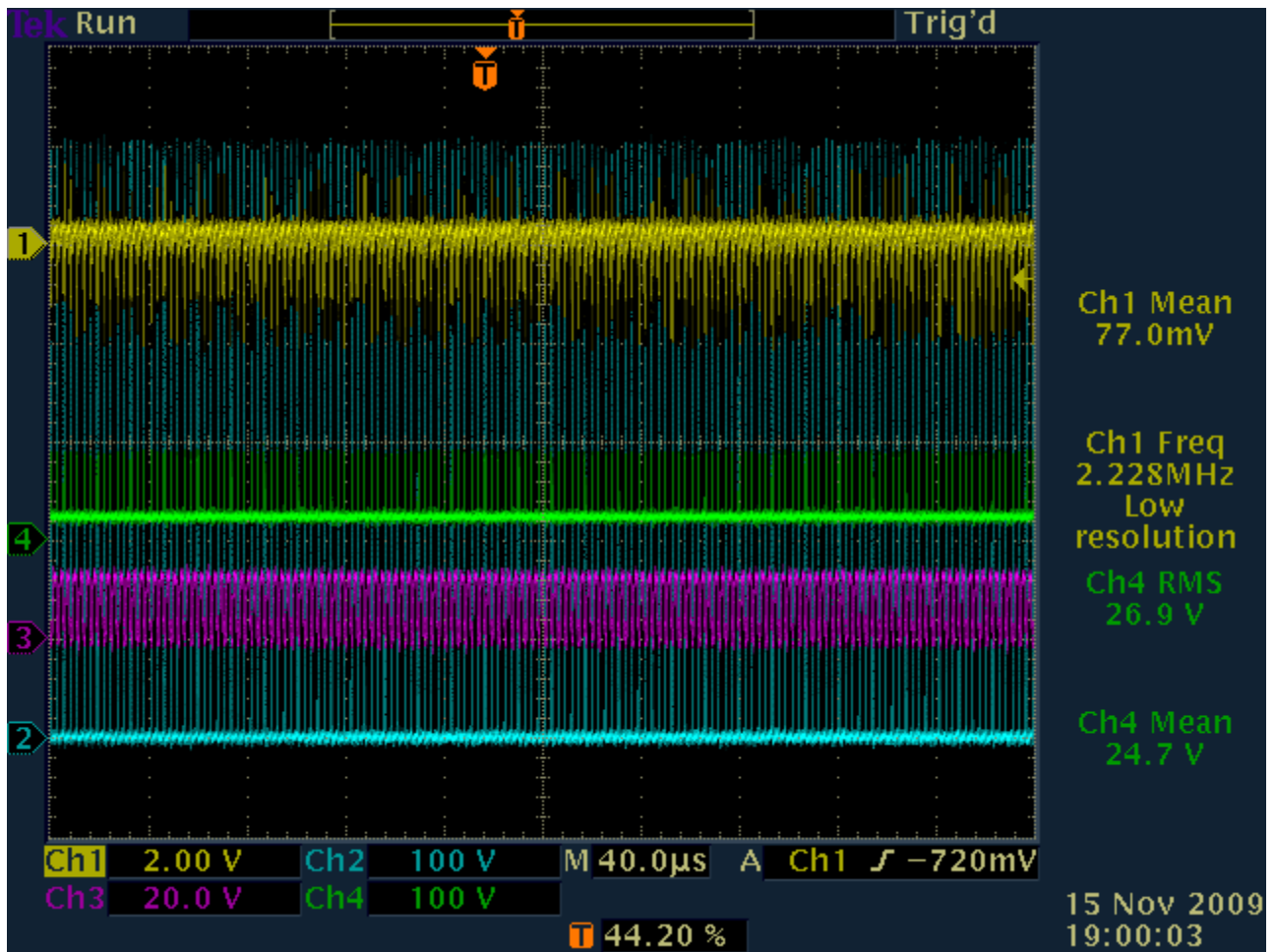

11\_2us

TEMPERATURE - IMAGE & DATA "KEY"

TEST #10  
11-15-09

1 HR X 6 MINUTE  
11-IMAGE & DATA

Initials \_\_\_\_\_ Date \_\_\_\_\_  
Prepared By \_\_\_\_\_  
Approved By \_\_\_\_\_

© WILSON JONES G7500 ColumnWrite ©

#	TIME	MS	TEK CSV	TEK PNG	AMBIENT °F	LOAD IOL °F	MOSFET °F	SHUNT °F
1	18:00	40	000	000	75.1	145	165	112
	DMM 24.73	2	001	001				
2	18:06	40	002	002	75.1	144	163	119
	DMM 24.72	2	003	003				
3	18:12	40	004	004	75.1	144	169	117
	DMM 24.71	2	005	005				
4	18:18	40	006	006	75.1	144	170	118
	DMM 24.70	2	007	007				
5	18:24	40	008	008	75.1	144	172	113
	DMM 24.69	2	009	009				
6	18:30	40	010	010	75.1	143	170	110
	DMM 24.68	2	011	011				
7	18:36	40	012	012	75.2	144	164	117
	DMM 24.68	2	013	013				
8	18:42	40	014	014	75.2	145	167	113
	DMM 24.67	2	015	015				
9	18:48	40	016	016	75.1	145	167	115
	DMM 24.66	2	017	017				
10	18:54	40	018	018	75.1	144	167	111
	DMM 24.65	2	019	019				
11	19:00	40	020	020	75.0	144	166	112
	DMM 24.64	2	021	021				
	CHANNEL 1		022					
	100NS		023					

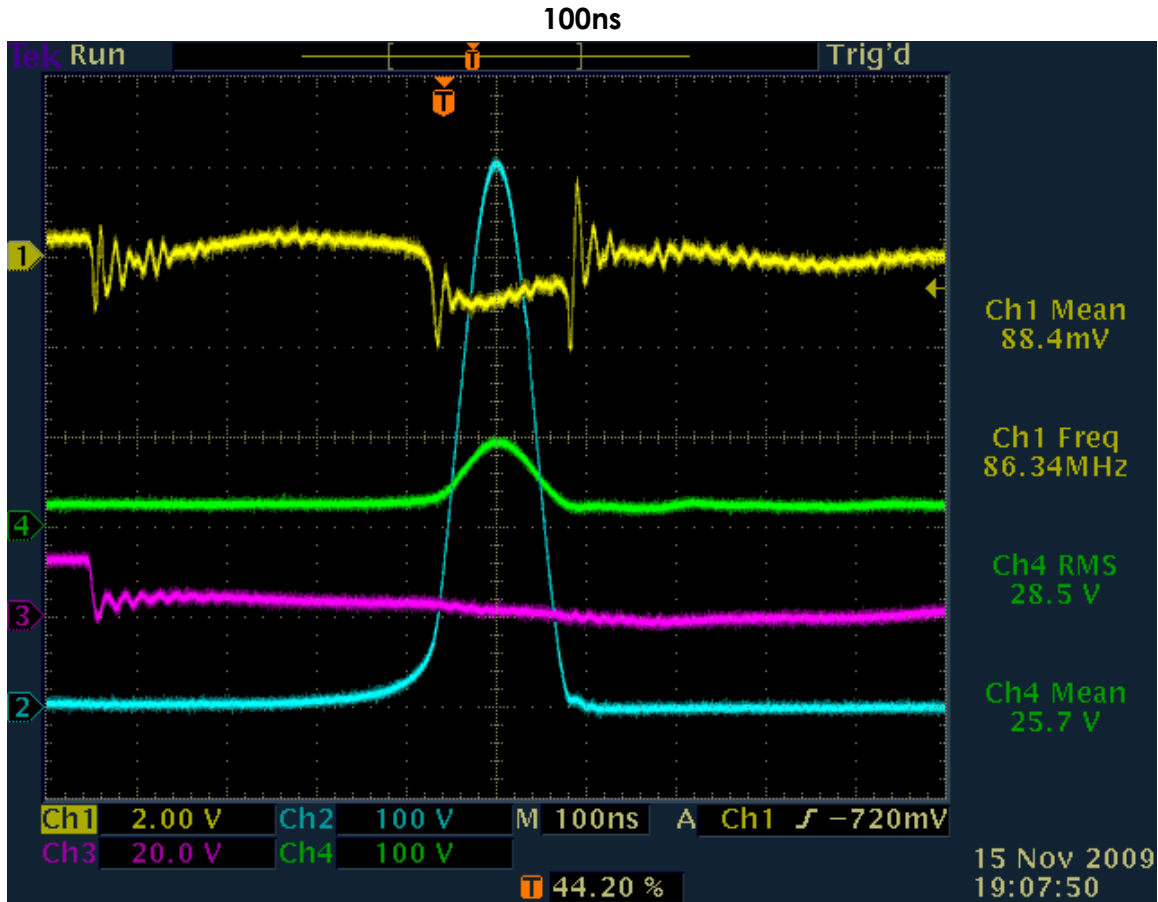

[Glen's Rosemary Ainslie COP>17 Heater Circuit – DATA TEST #10](#)

**Test #11**

I did a short test using a new replication of the "Quantum" October 2002 Load Resistor, as per some revised specifications from Harvey and Rosie with a 32mm x 254mm coil on a 280mm piece of "Borosilicate" glass tubing and a calculated inductance of 8.64 uH @ 48 turns of 22AWG Ni Cr type A wire.

The results were somewhat expected with the Mosfet Drain spikes (Channel-2) smaller in amplitude but the battery spikes (Channel-4) remained the same, the Channel-1 mV readings were much larger than a normal running at the frequency that I'm usually operating at. The Load resistor temperature was between 110 and 140 degrees F a normal range, and the Mosfet was running at 200 to 260 degrees F much higher than normal.

I was also refining the gate pot type for publication and am going to wind another load resistor coil for a comparison between my original prototype resistor with the same center to center coil wire spacing but using the "HUGE" 76mm "Borosilicate" glass 6 inch

long tubing shown in the set-up photograph.

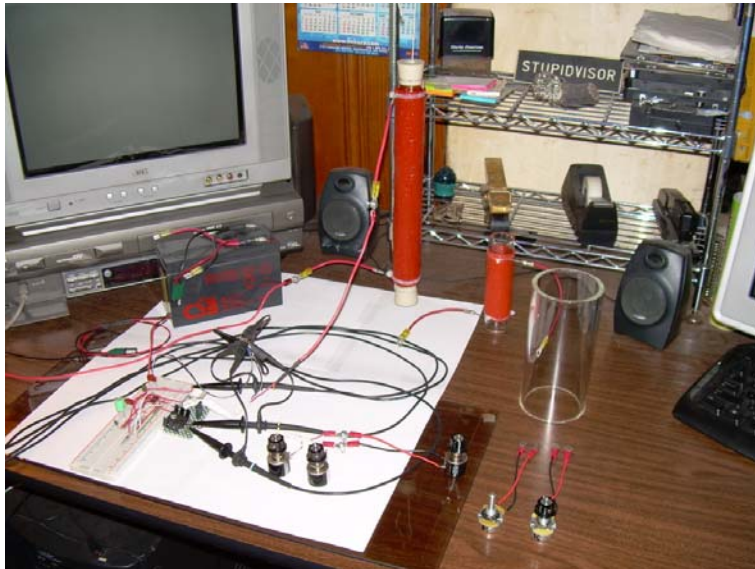

[Rosemary Ainslie COP>17 Heater Circuit](#)  
["Quantum" October 2002](#)

**Replication Components -**

- 1) [International Rectifier - IRFPG50 HEXFET® Power MOSFET](#)  
w/ Sil-Pad insulator between Mosfet and Heat Sink
- 2) [Fairchild Semiconductor - NE555N Timer](#)
- 3) [Vishay Spectrol - SP534 Percision Potentiometer/ 10-turn 2-Watt](#)
- 4) [Exide Technologies Battery "Liquid Lead Acid" Model # GT-H - TRACTOR 12V 12Ah CCA 235](#)
- 5) CSB Battery Company "Gel Lead Acid" #GP 1270 F2 / 12 Volt 7.0 Ah
- 6) Prototype "Quantum" Load Resister 10 ohm 32mm x 254mm
- 7) "Shunt" - Caddock High Performance Film Resistor "non-inductive" 30 watt type  
[MP930-0.25-1%](#)

**Channel 1 - Mosfet source shunt**

Channel 2 - Mosfet drain  
Channel 3 - 555 Timer pin #3  
Channel 4 - 24 VDC "Liquid" Lead Acid Battery Bank

40us

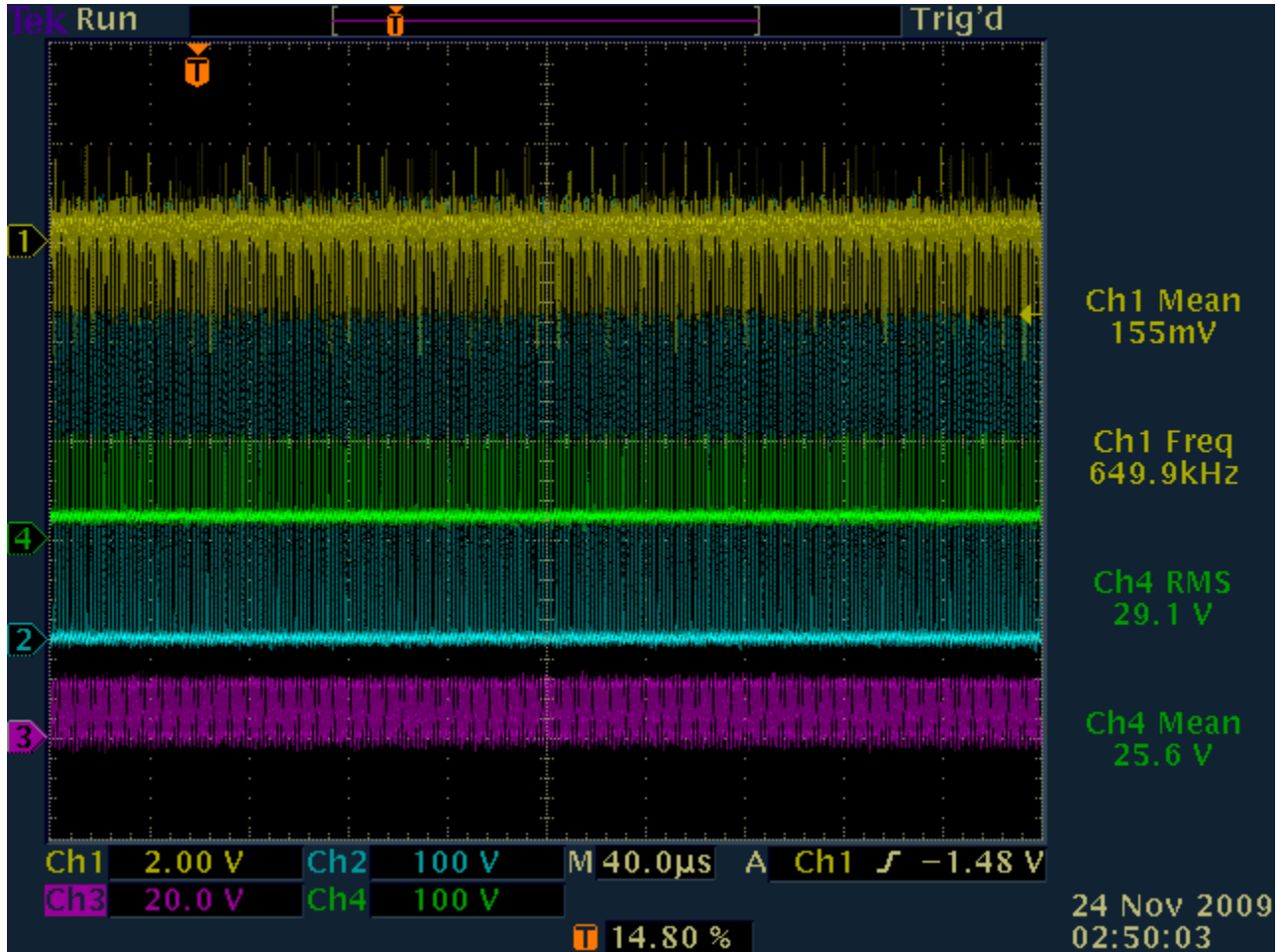

20us



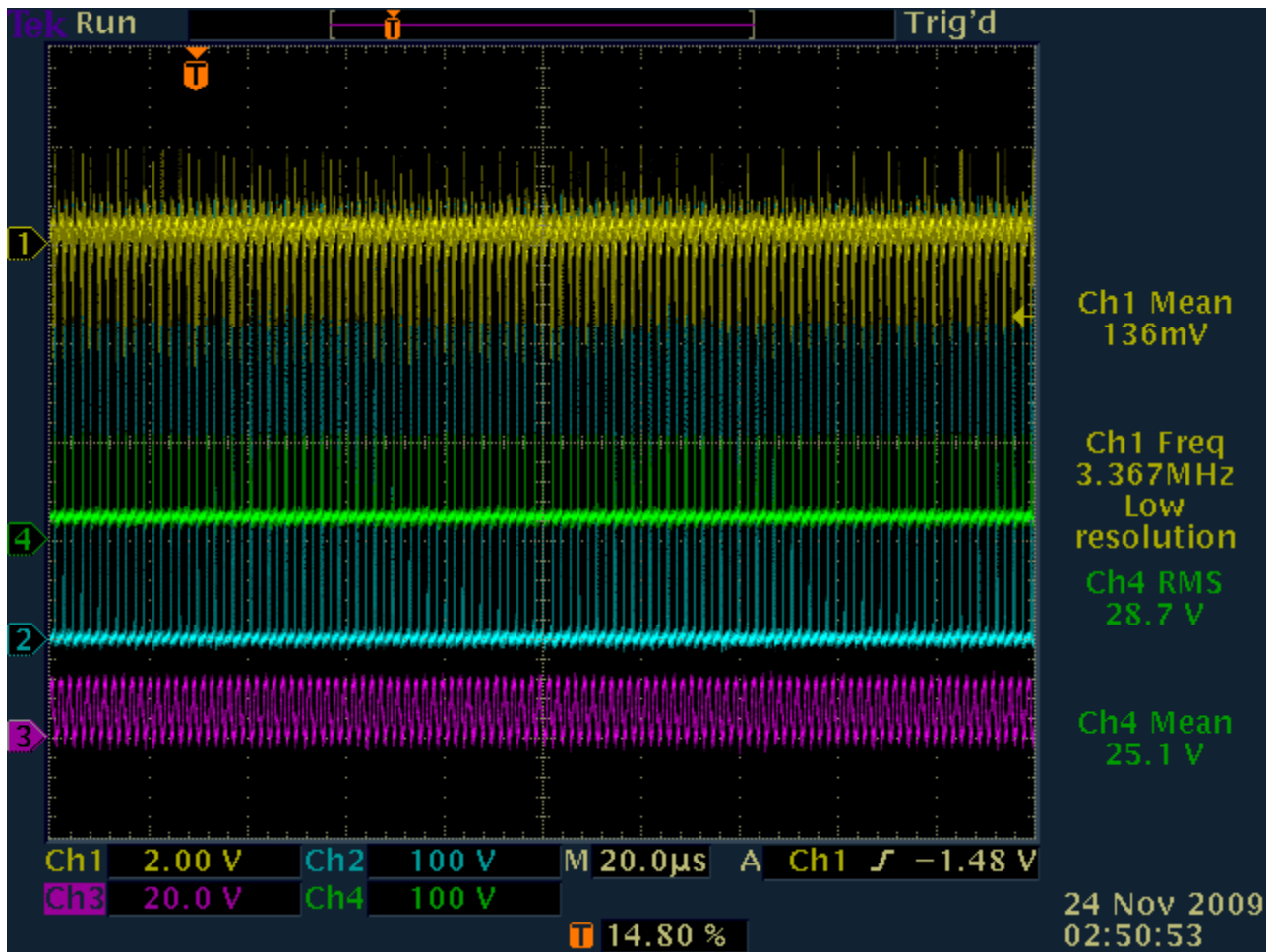

2us

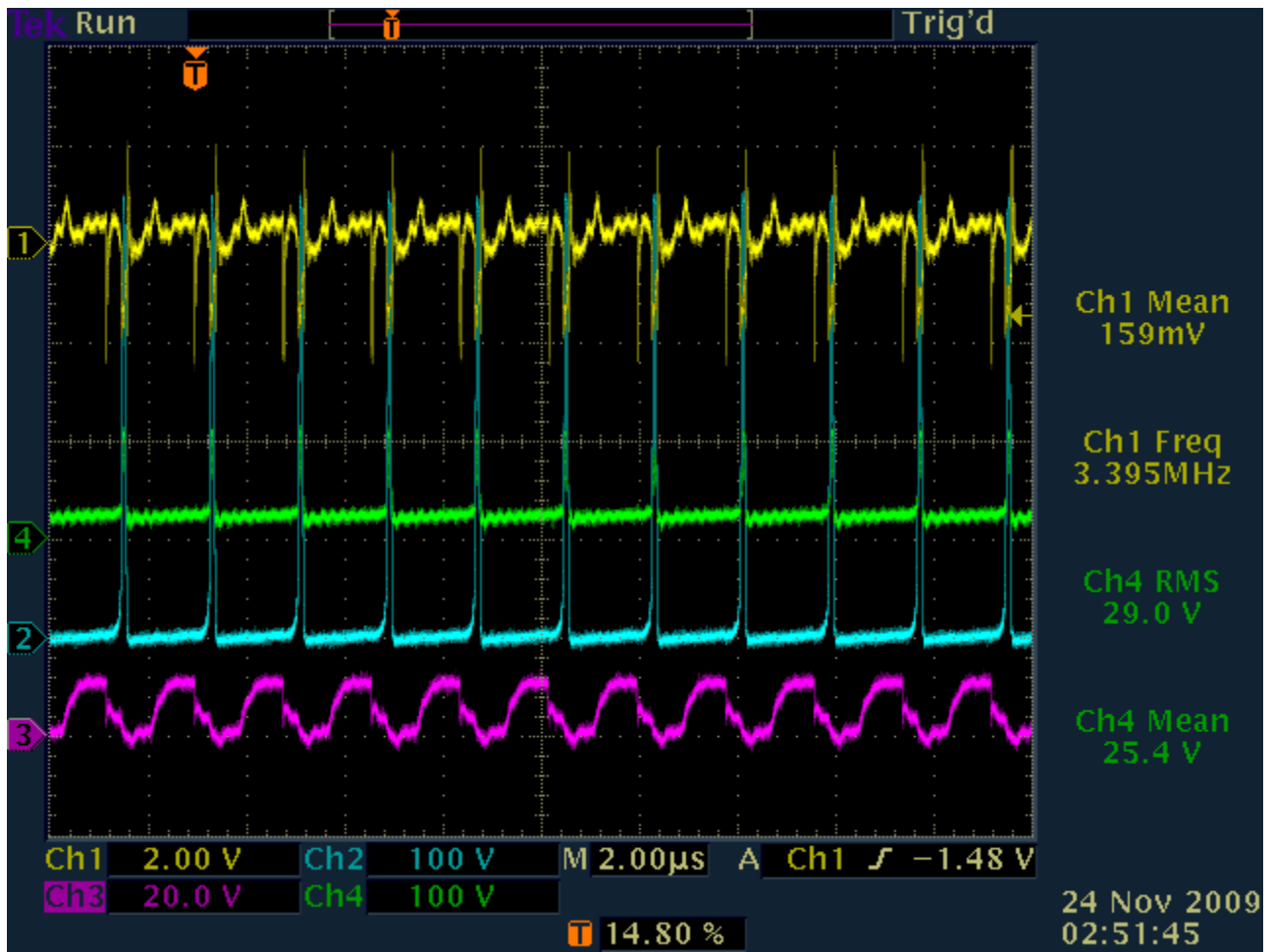

100ns

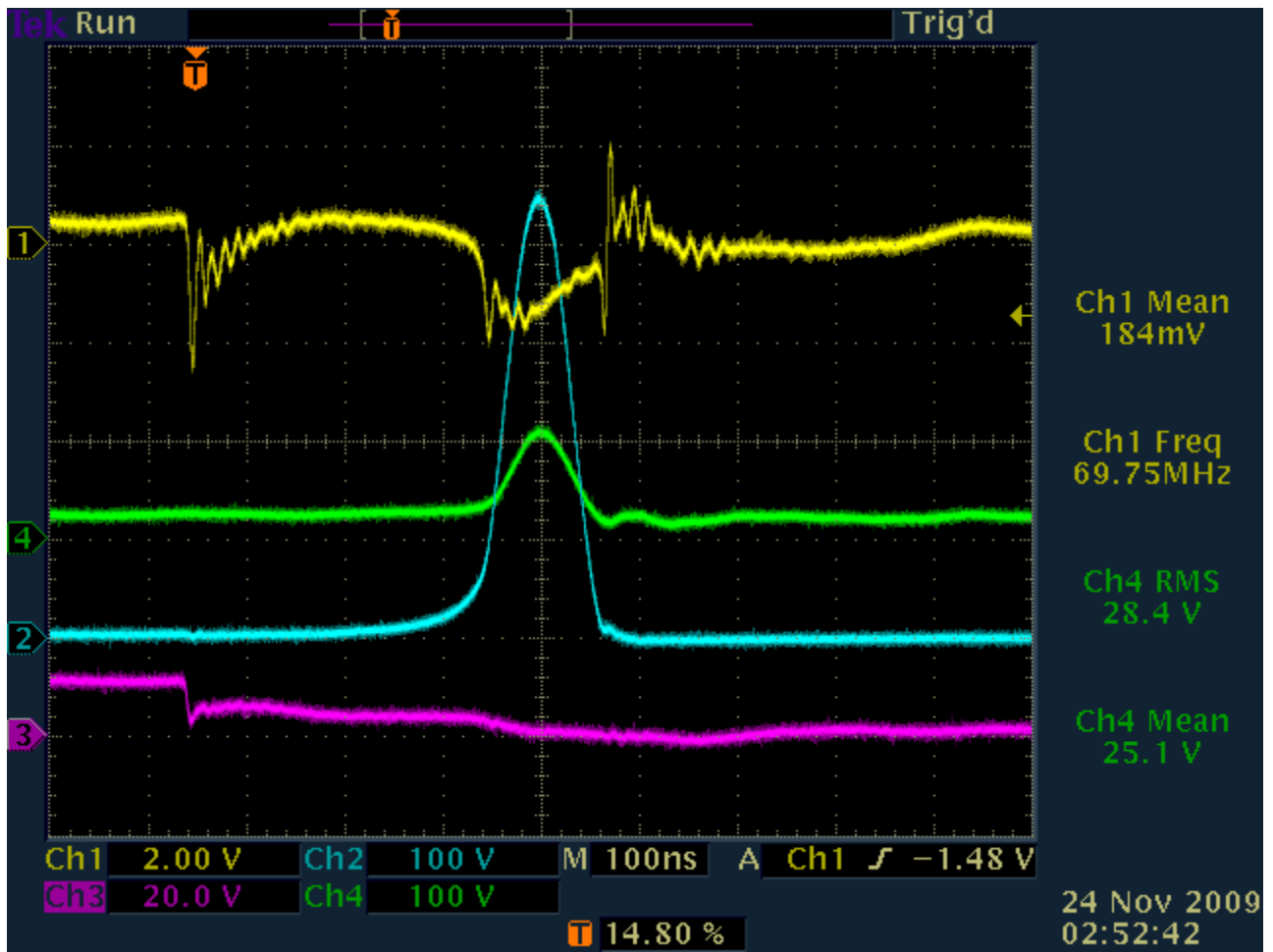

Channel-1

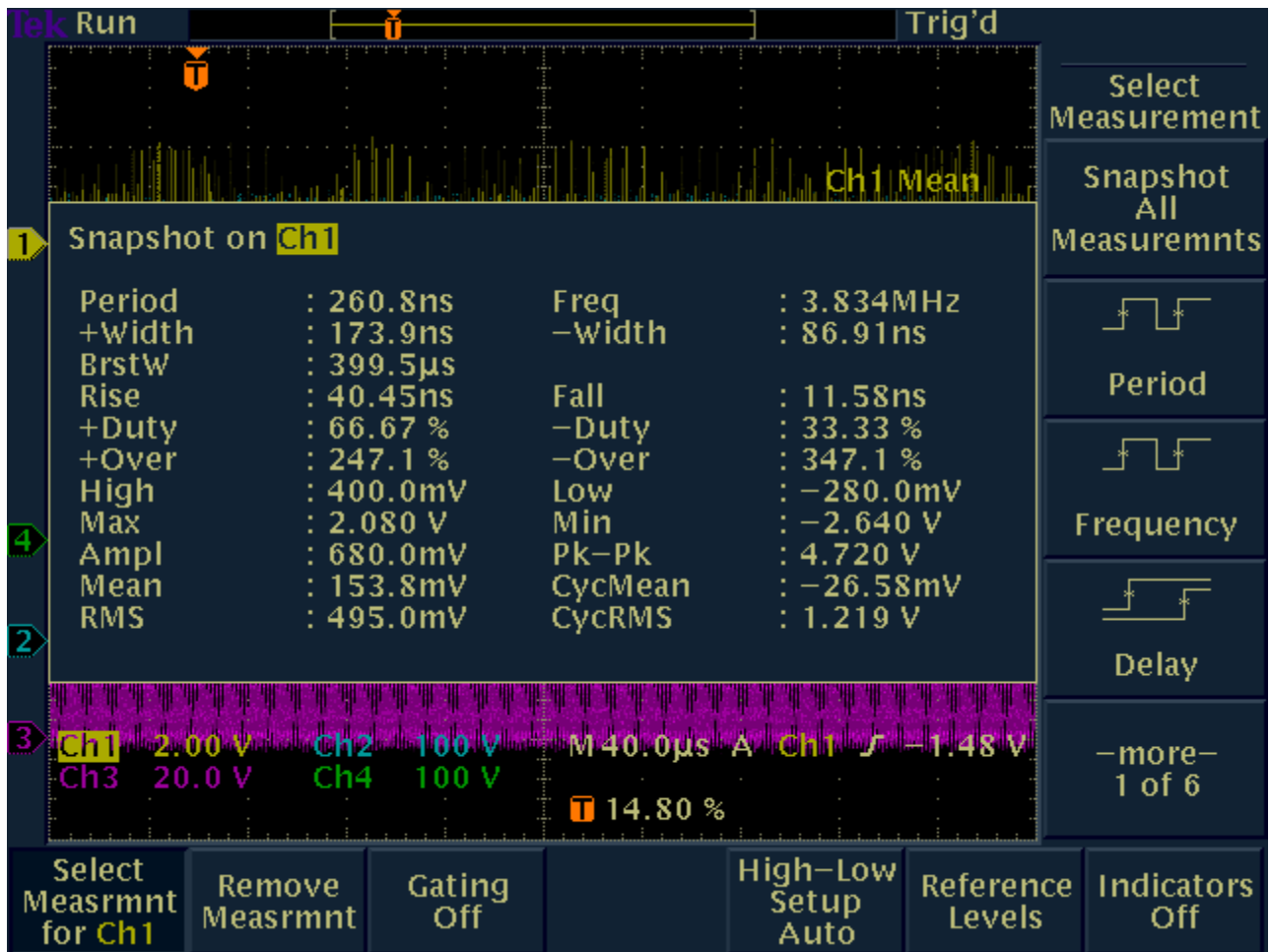

Channel-2

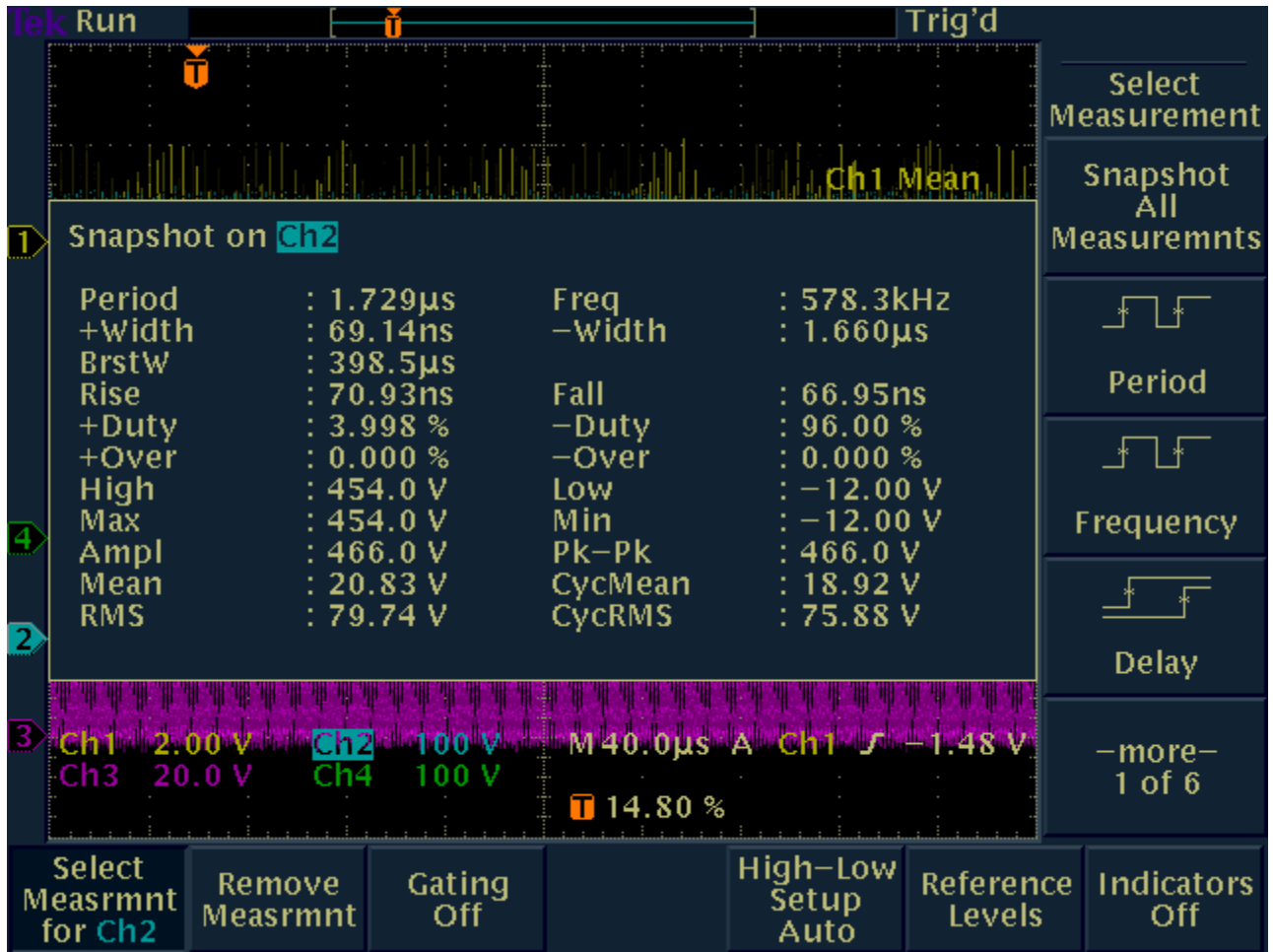

Channel-3

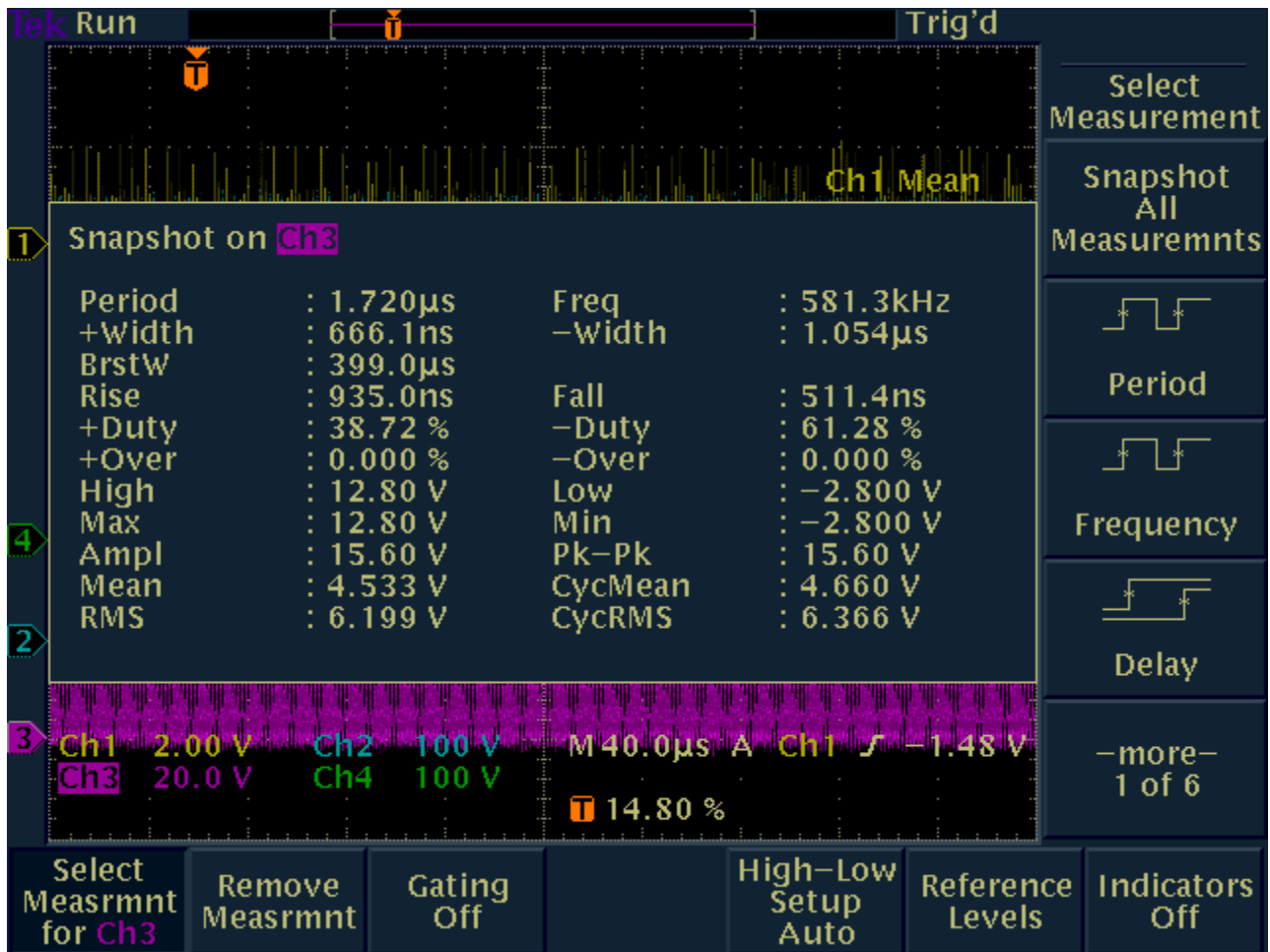

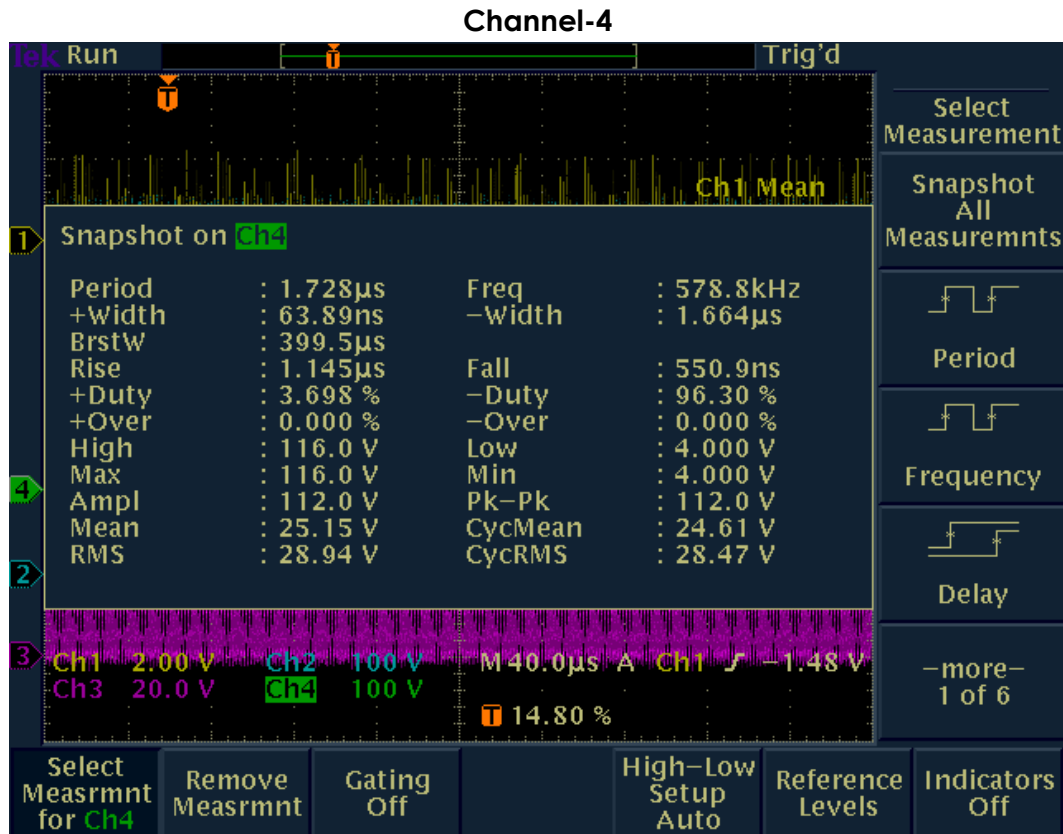

**Note on this test from Rose-** Fuzzy has just done a test on a resistor that closely approximates our quantum test resistor. He took the frequency down to 70 KHz and the sad news is that the advantage was completely lost. Please, therefore, do not get married to the quantum frequency. Test a range of this and the chances are that you will need to run at a higher frequency and possibly also a higher duty cycle. The assumption is that your 555 switching arrangement are in line with Fuzzy's and Aaron's before him. I suspect that the best guide here will be to let the circuit find its own preferred oscillation. Component variations seem to result in HUGE variations in frequency.

[Glen's Rosemary Ainslie COP>17 Heater Circuit – DATA TEST #11](#)

### TEST #12

Here is TEST #12 .... it's a one (1) hour test with 40us and 2us readings taken every six (6) minutes for a total of eleven (11) readings or twenty two (22) Image and Data files for one (1) hour.

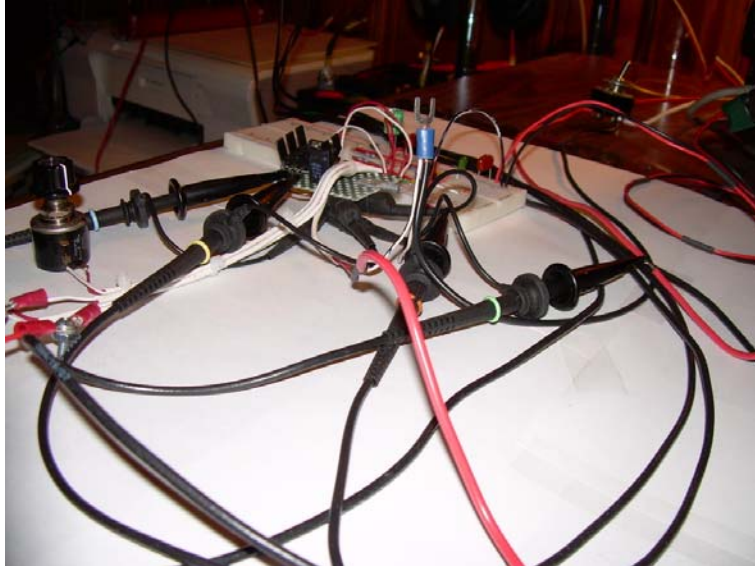

[Rosemary Ainslie COP>17 Heater Circuit  
"Quantum" October 2002](#)

#### **Replication Components -**

- 1) [International Rectifier - IRFPG50 HEXFET® Power MOSFET](#)  
w/ Sil-Pad insulator between Mosfet and Heat Sink
- 2) [Fairchild Semiconductor - NE555N Timer](#)
- 3) [Vishay Spectrol - SP534 Percision Potentiometer/ 10-turn 2-Watt](#)
- 4) [Exide Technologies Battery "Liquid Lead Acid" Model # GT-H - TRACTOR 12V 12Ah  
CCA 235](#)
- 5) CSB Battery Company "Gel Lead Acid" #GP 1270 F2 / 12 Volt 7.0 Ah
- 6) Prototype "Quantum" Load Resister 10 ohm + - 5%
- 7) "Shunt" - Caddock High Performance Film Resistor "non-inductive" 30 watt type  
[MP930-0.25-1%](#)

#### **Temperature Measurements -**

Fluke 62 "mini" IR Themometer ( used maximum reading on each component )

#### **Digital Mulit Meter -**



Fluke 87 DMM true RMS

- Channel 1 - Mosfet source shunt
- Channel 2 - Mosfet drain
- Channel 3 - 555 Timer pin #3
- Channel 4 - 24 VDC "Liquid" Lead Acid Battery Bank

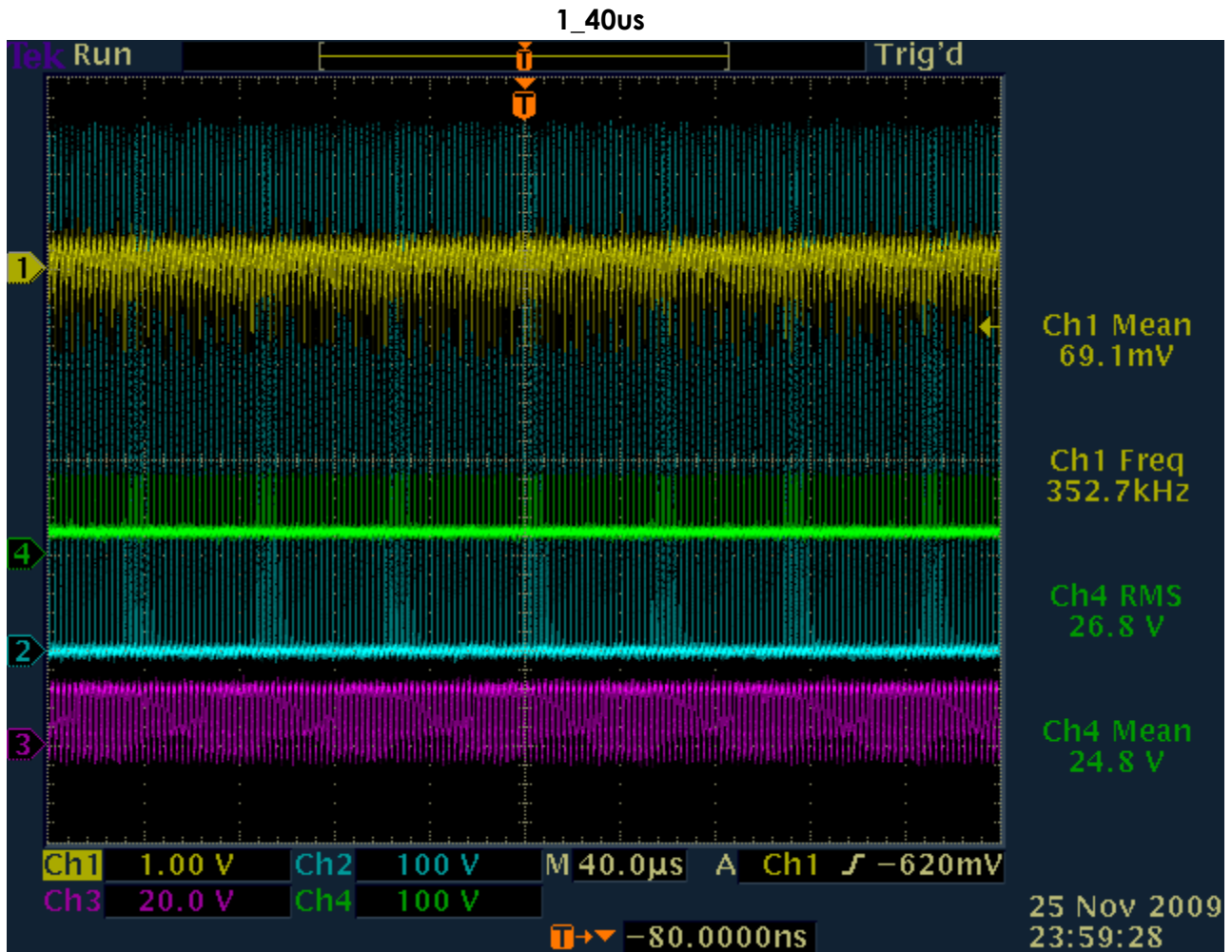

1\_2us

2\_40us

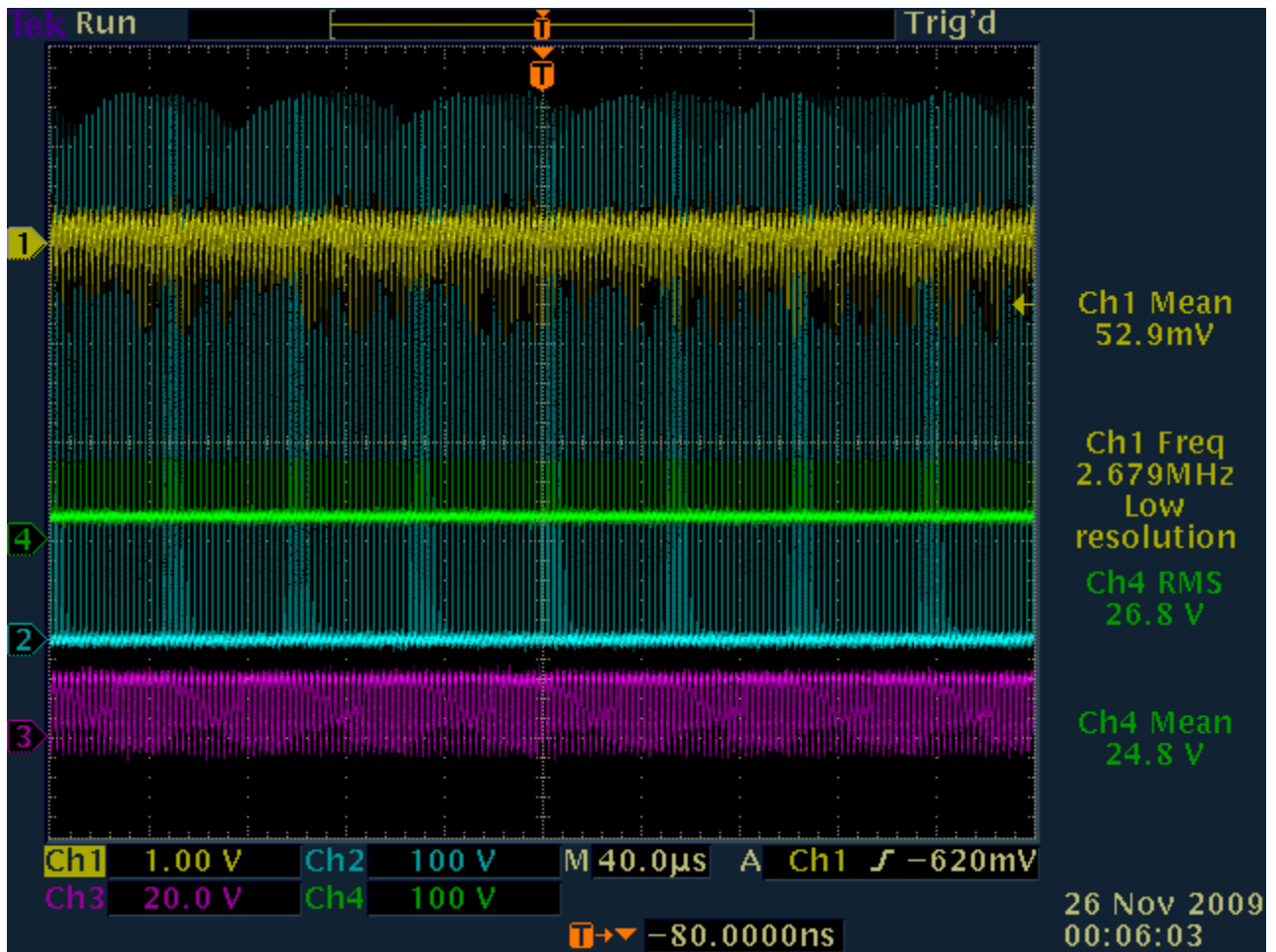

2-2us

3\_40us

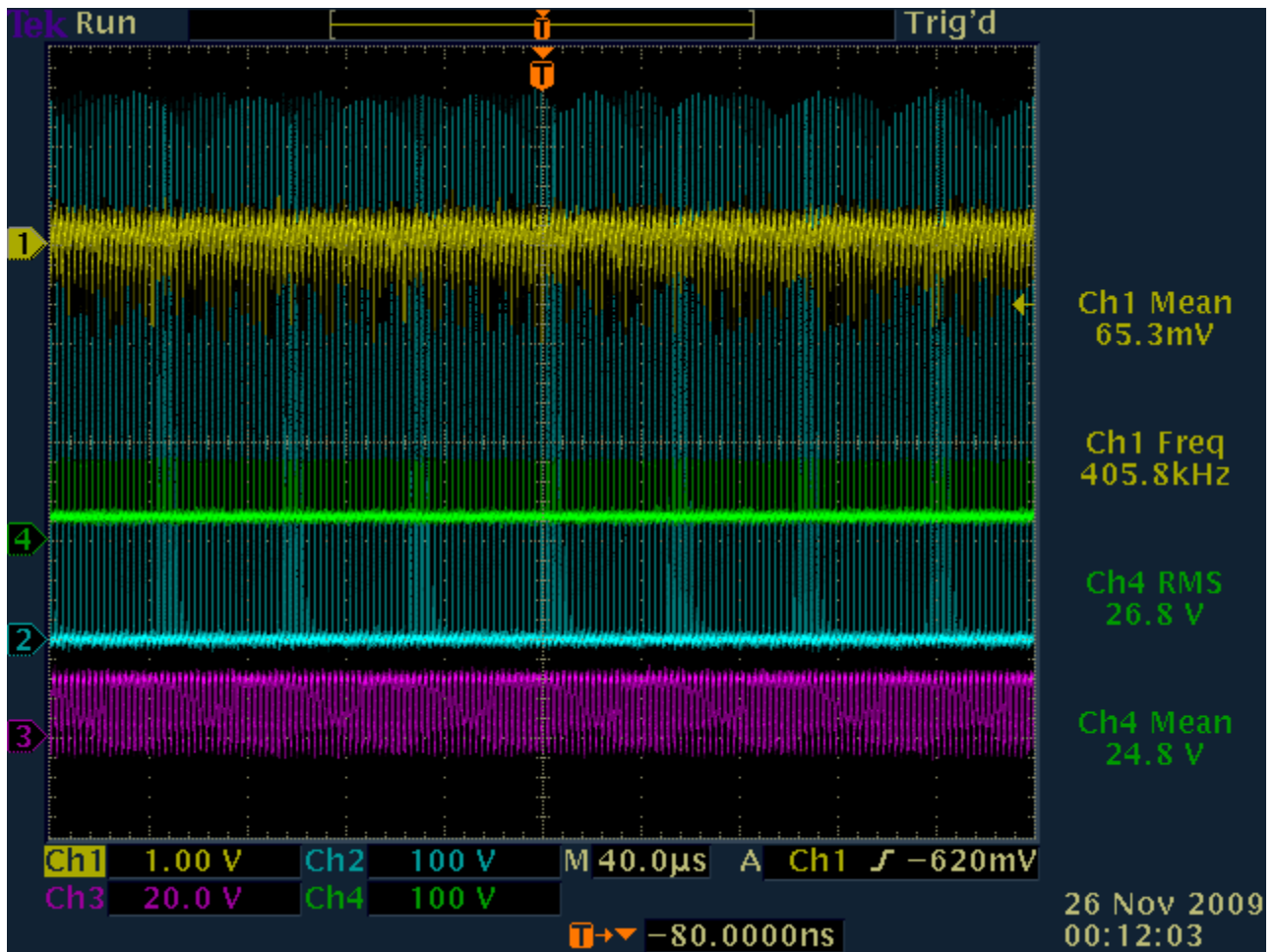

3\_2us

4\_40us

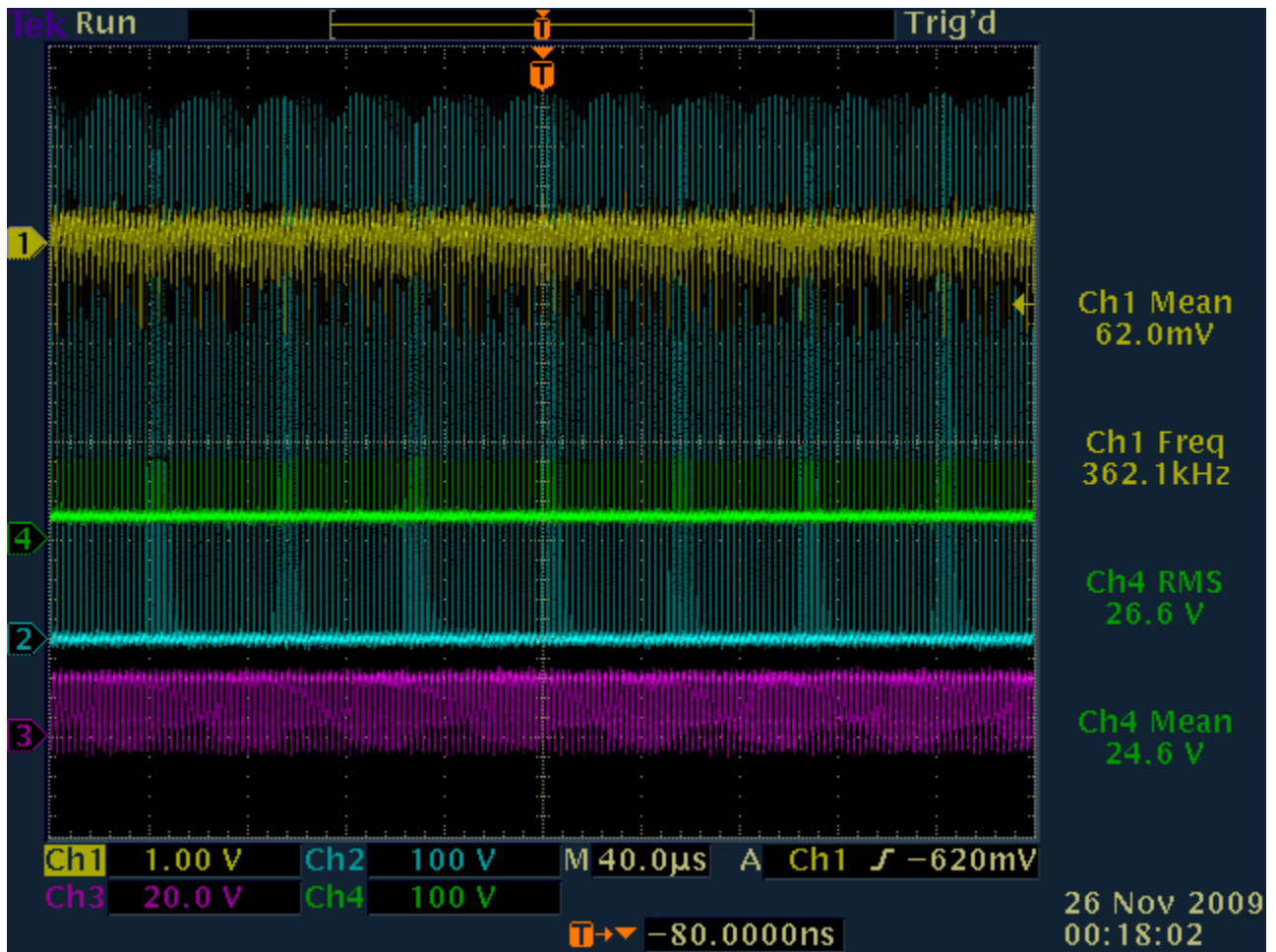

4\_2us

5\_40us

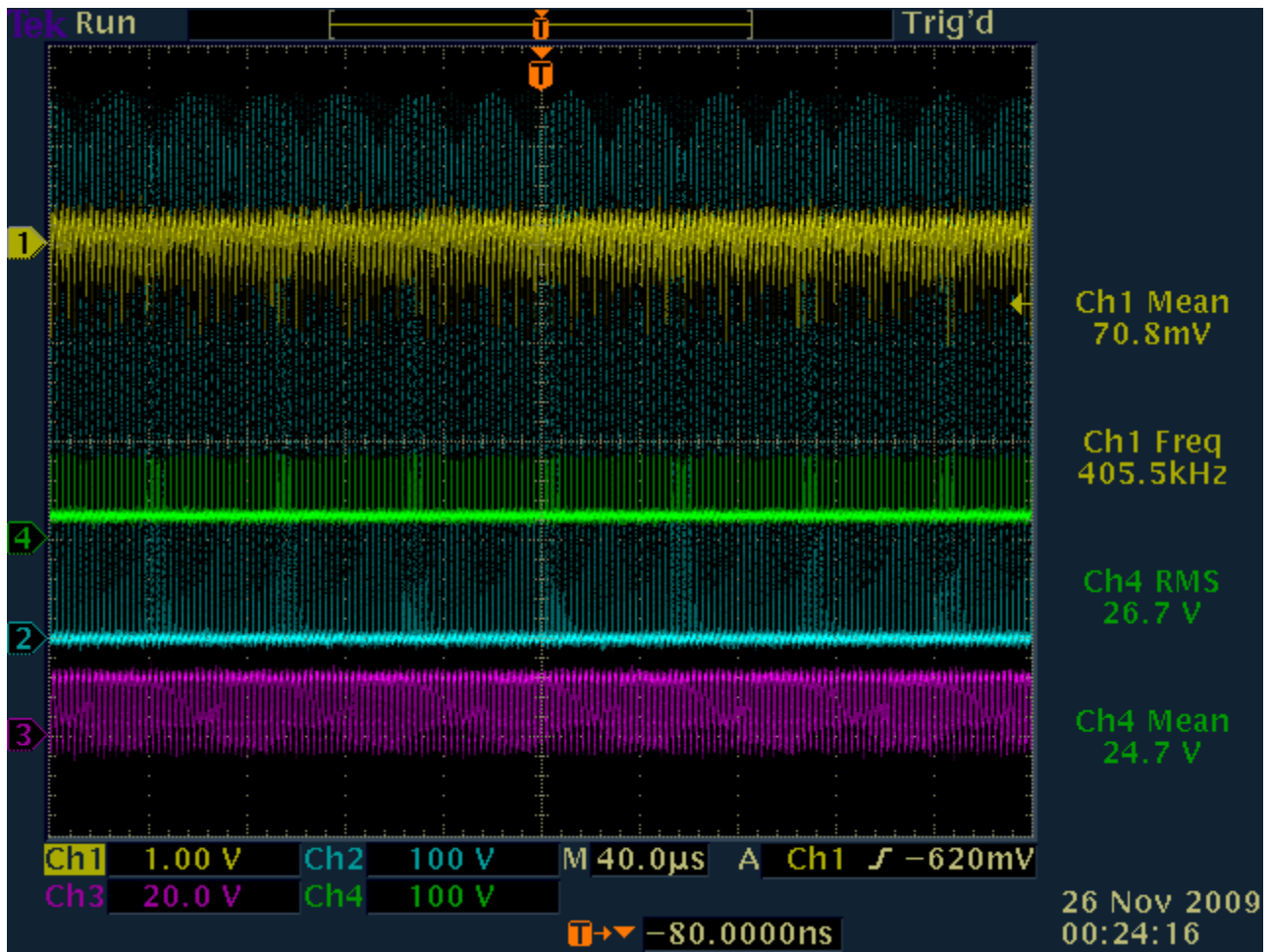

5\_2us

6\_40us

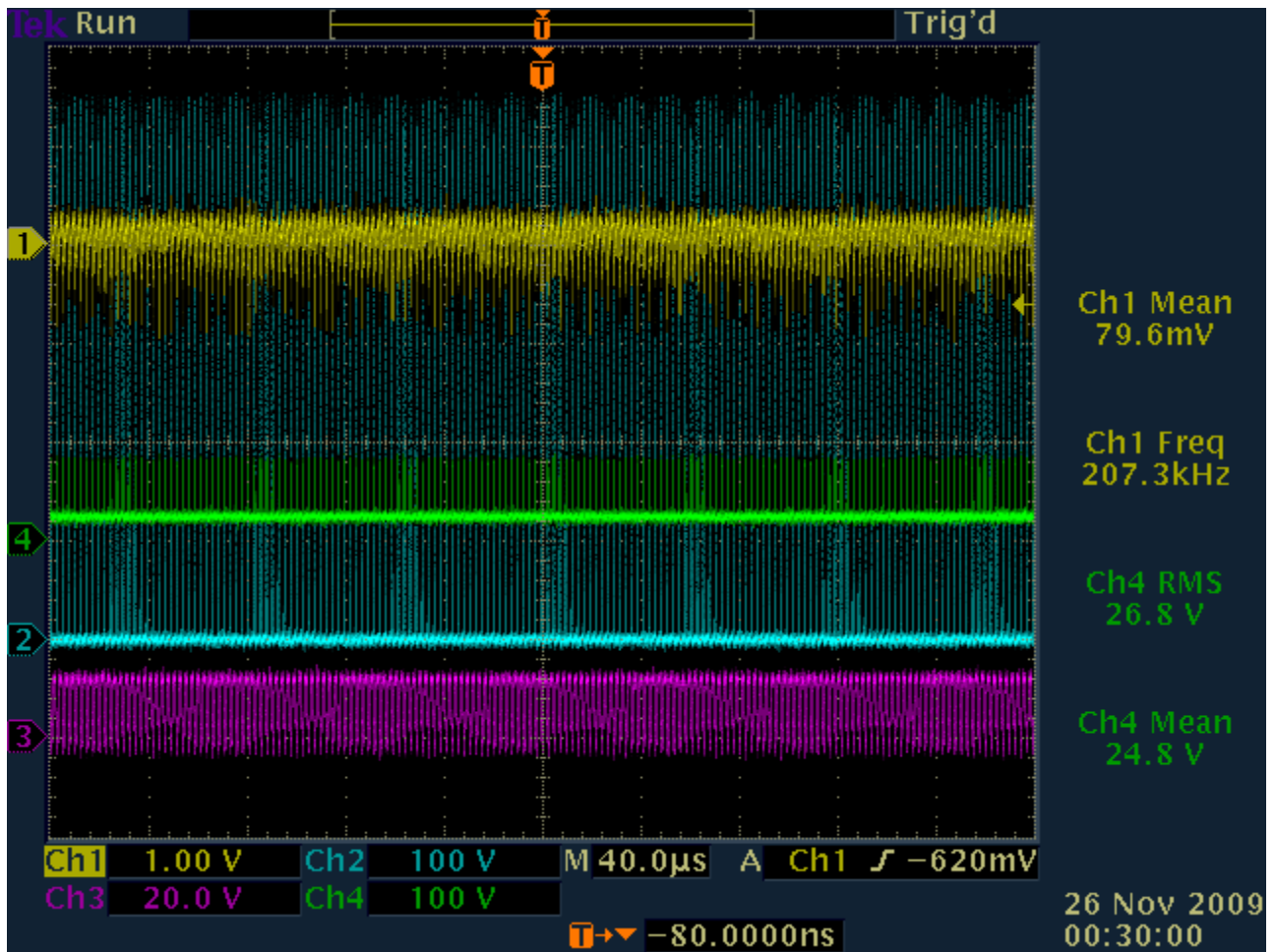

6\_2us

7\_40us

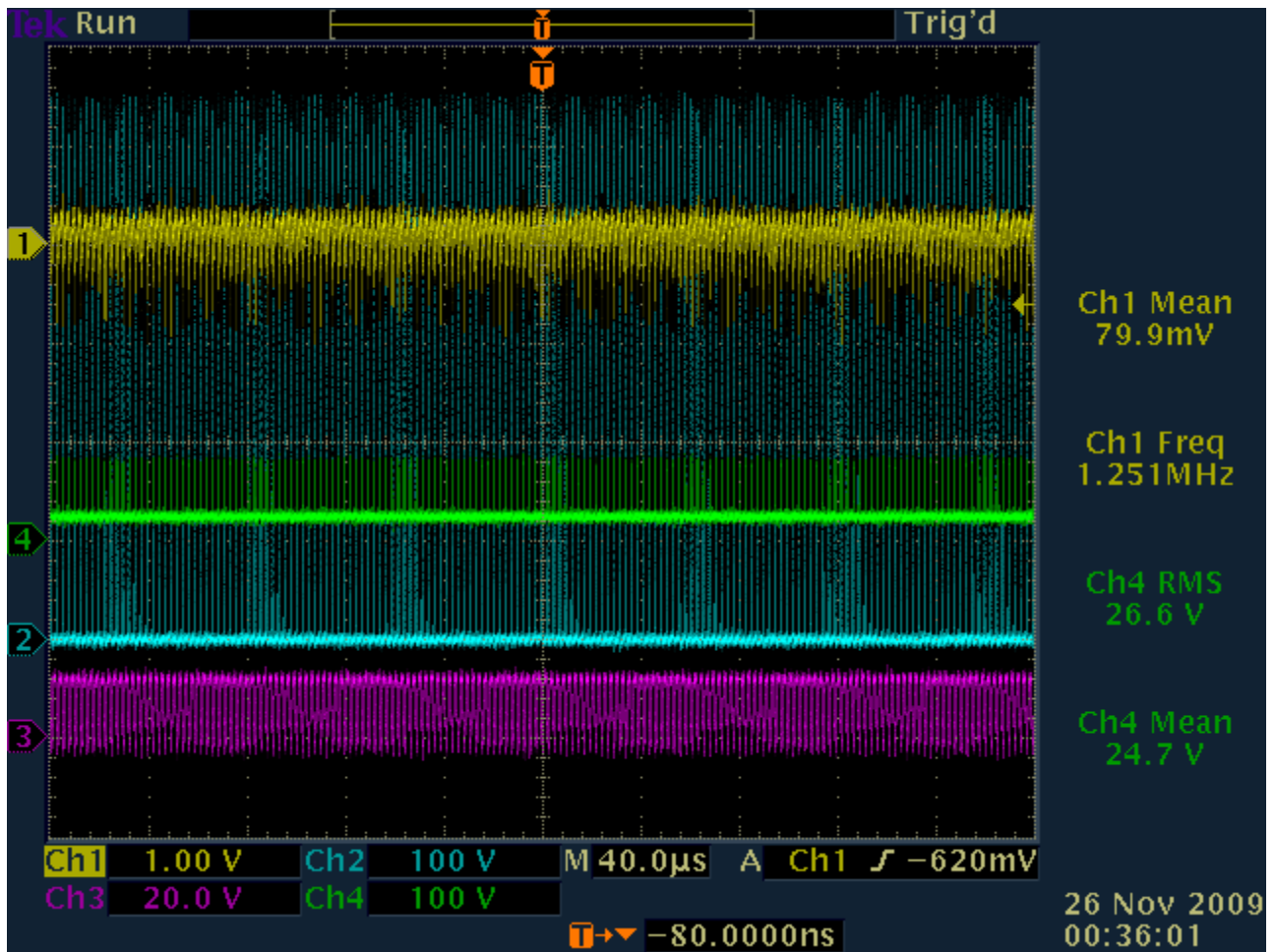

7\_2us

8\_40us

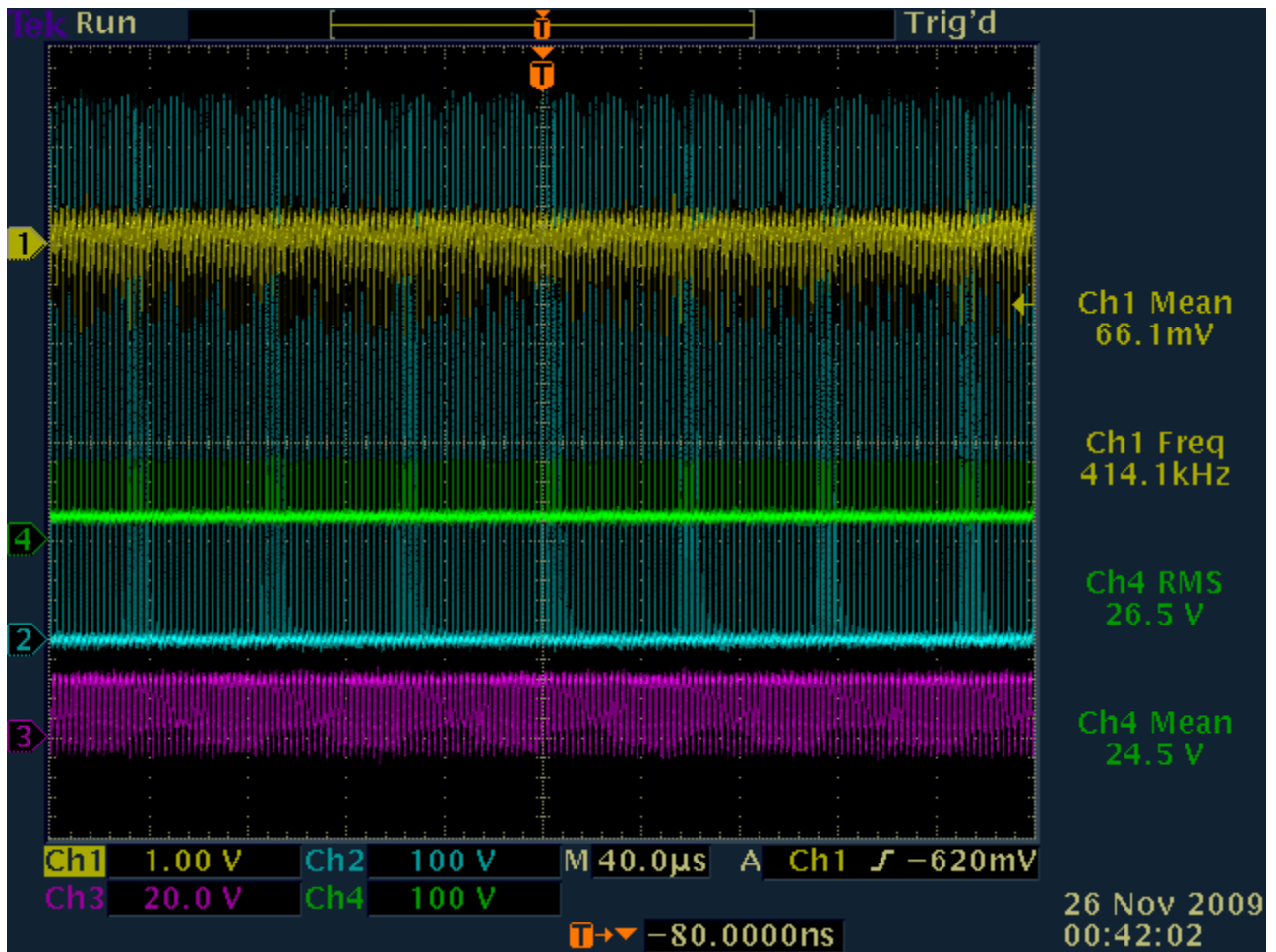

8\_2us

9\_40us



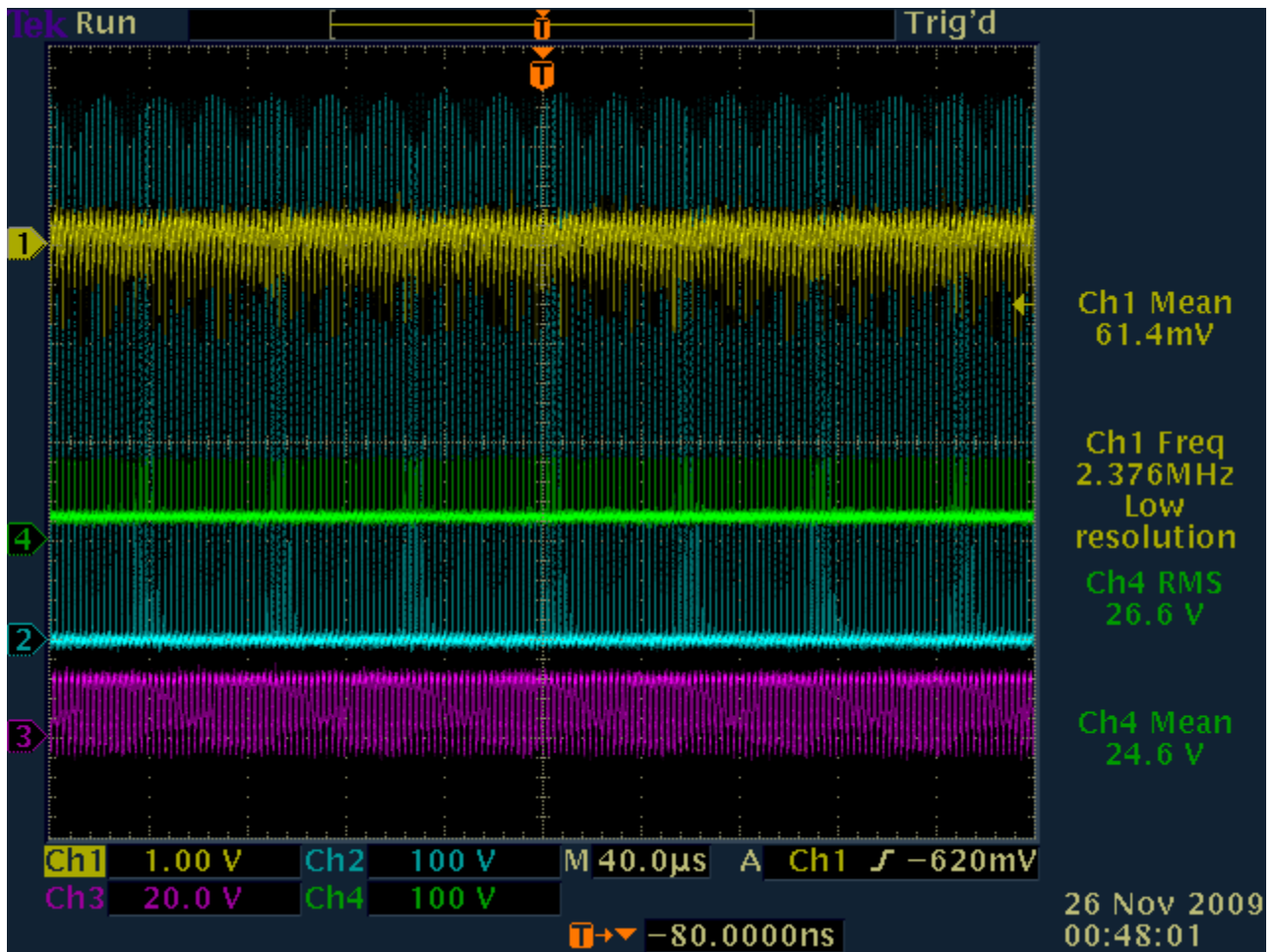

9\_2us

10\_40us

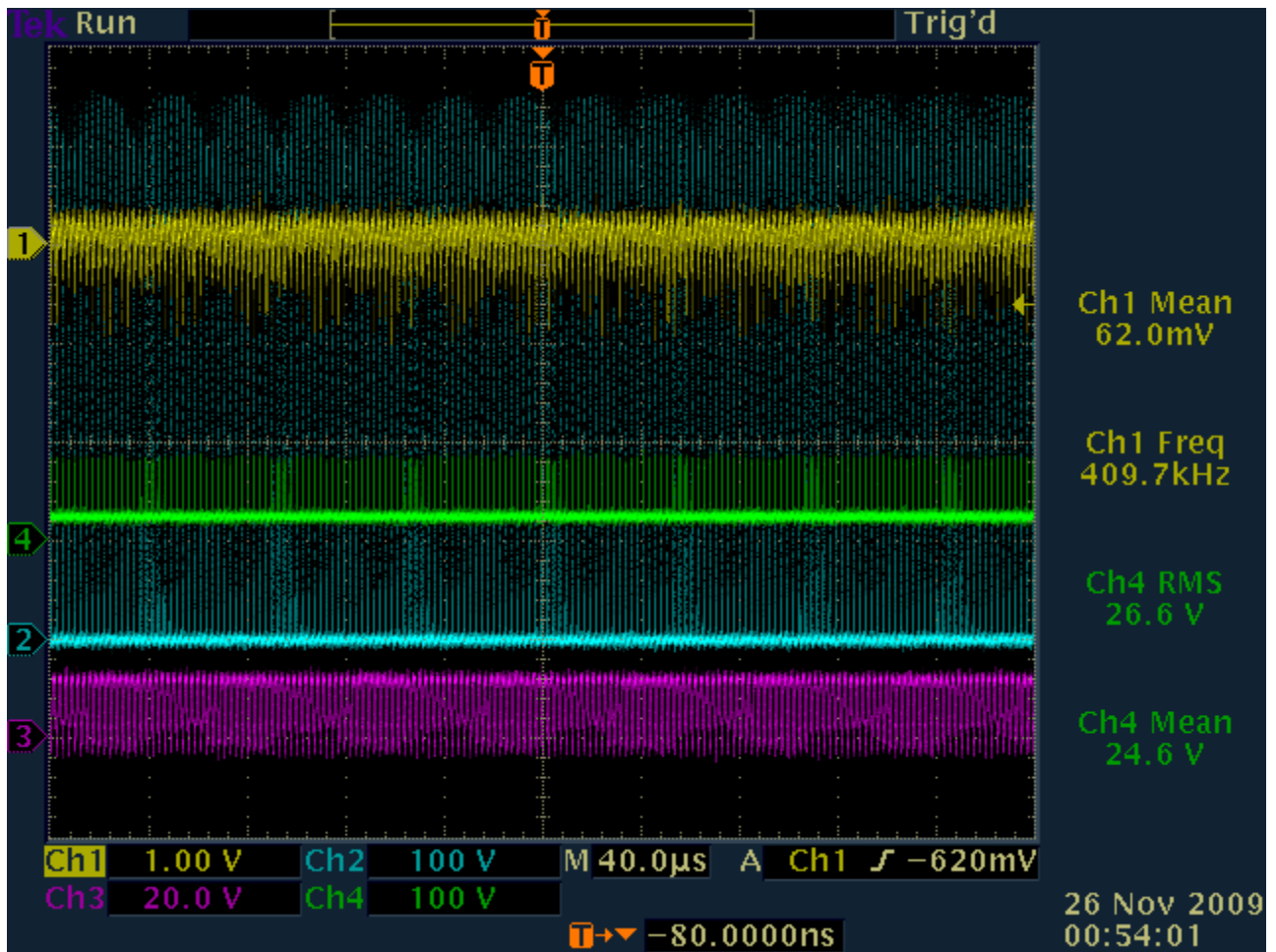

10\_2us

11\_40us

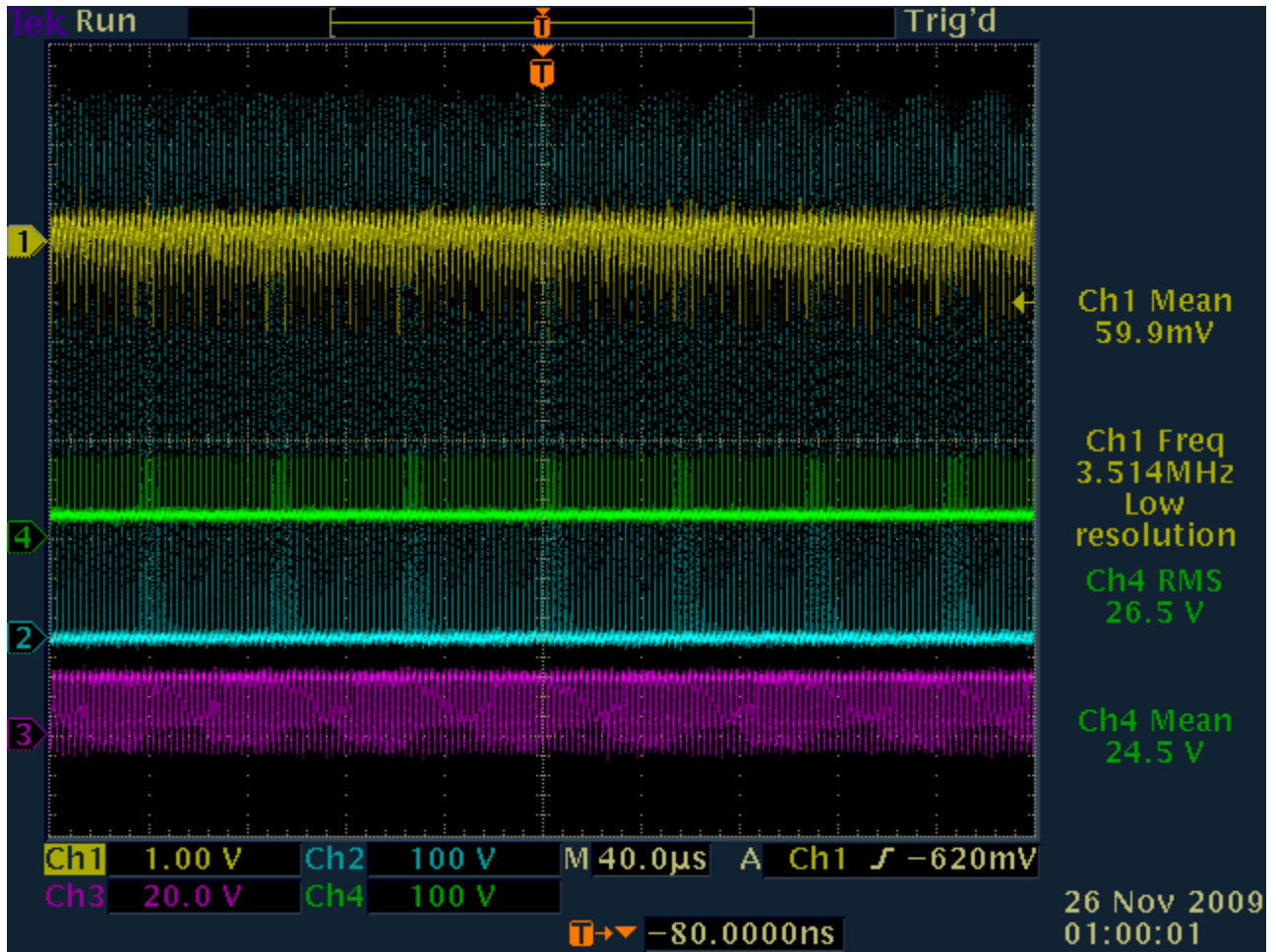

11\_2us

Thermal Data w/ Original Image Key

TEST #12  
11-26-09

1 HR X 6 MINUTE  
11 IMAGE & DATA

Prepared By	Initials	Date
Approved By		

© WILSON JONES

07506 ColorWrite II

#	TIME	MS	TEK CSV	TEK PNG	AMBIENT °F	LOAD 10 JL °F	MOSFET °F	SHUNT °F
1	00:00	40	000	000	74.8	138	165	108
	DMM 24.96	2	001	001				
2	00:06	40	002	002	74.8	138	165	115
	DMM 24.95	2	003	003				
3	00:12	40	004	004	75.0	137	162	111
	DMM 24.94	2	005	005				
4	00:18	40	006	006	74.8	137	161	107
	DMM 24.93	2	007	007				
5	00:24	40	008	008	74.5	138	161	103
	DMM 24.92	2	009	009				
6	00:30	40	010	010	74.0	139	162	107
	DMM 24.92	2	011	011				
7	00:36	40	012	012	73.8	138	160	107
	DMM 24.91	2	013	013				
8	00:42	40	014	014	73.8	138	160	105
	DMM 24.90	2	015	015				
9	00:48	40	016	016	73.6	138	160	105
	DMM 24.90	2	017	017				
10	00:54	40	018	018	73.6	137	161	112
	DMM 24.89	2	019	019				
11	01:00	40	020	020	73.6	138	160	109
	DMM 24.88	2	021	021				
	CHANNEL-1			022				
	CHANNEL-2			023				
	CHANNEL-3			024				
	CHANNEL-4			025				
	LOONS			026				

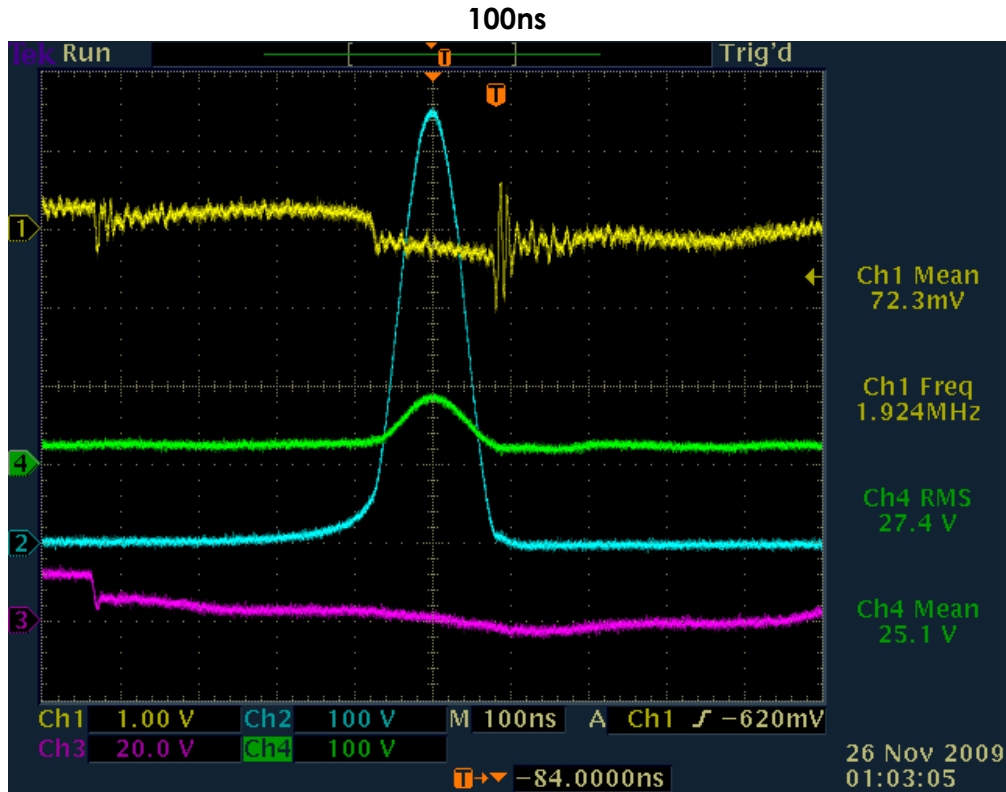

### Snap Shot Images - 40us

All Images and data from a Tektronix TDS 3054C from the Tektronix Corporation

[Glen's Rosemary Ainslie COP>17 Heater Circuit – DATA TEST #12](#)

Here is a "YouTube" video of Test #5 "FINISH" the last of recording of Images and Data at 40us, 20us and 2us divisions of the 6 hour test with circuit set up and additional wave forms included.

[Rosemary Ainslie COP>17 Heater Circuit - TEST #5 - Image and Data Recording](#)

[Rosemary Ainslie COP17 Heater Circuit - TEST #5 - Image and Data Recording - Complete - with Set Up and Additional Wave Forms](#)

### Test #13

Here is TEST #13 .... it's another one (1) hour test with 40us and 2us readings taken every six (6) minutes for a total of eleven (11) readings or twenty two (22) Image and Data files for one (1) hour.

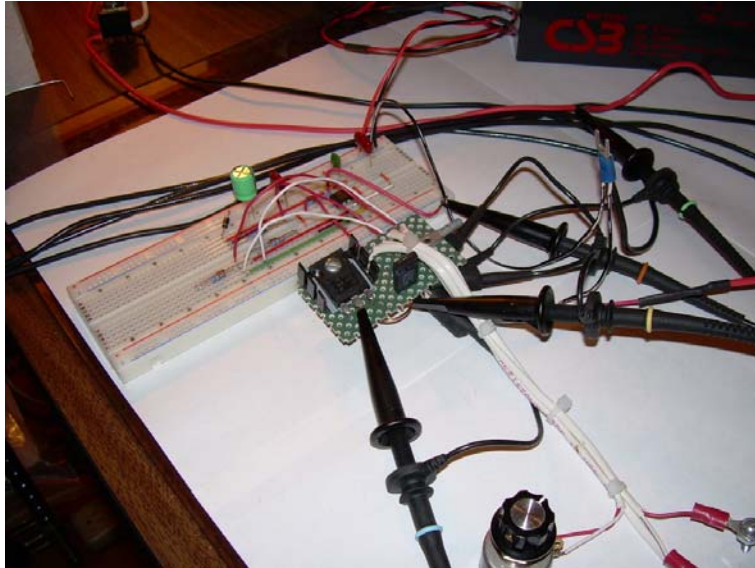

[Rosemary Ainslie COP>17 Heater Circuit](#)  
["Quantum" October 2002](#)

**Replication Components -**

- 1) [International Rectifier - IRFPG50 HEXFET® Power MOSFET](#)  
w/ Sil-Pad insulator between Mosfet and Heat Sink
- 2) [Fairchild Semiconductor - NE555N Timer](#)
- 3) [Vishay Spectrol - SP534 Precision Potentiometer/ 10-turn 2-Watt](#)
- 4) [Exide Technologies Battery "Liquid Lead Acid" Model # GT-H - TRACTOR 12V 12Ah CCA 235](#)
- 5) CSB Battery Company "Gel Lead Acid" #GP 1270 F2 / 12 Volt 7.0 Ah
- 6) Prototype "Quantum" Load Resister 10 ohm + - 5%
- 7) "Shunt" - Caddock High Performance Film Resistor "non-inductive" 30 watt type  
[MP930-0.25-1%](#)

**Temperature Measurements -**

Fluke 62 "mini" IR Themometer ( used maximum reading on each component )

# Digital Multimeter -

Fluke 87 DMM true RMS

- Channel 1 - Mosfet source shunt
- Channel 2 - Mosfet drain
- Channel 3 - 555 Timer pin #3
- Channel 4 - 24 VDC "Liquid" Lead Acid Battery Bank

Gate Potentiometer set at - 6.1 Ohms (+ -)

1\_40us

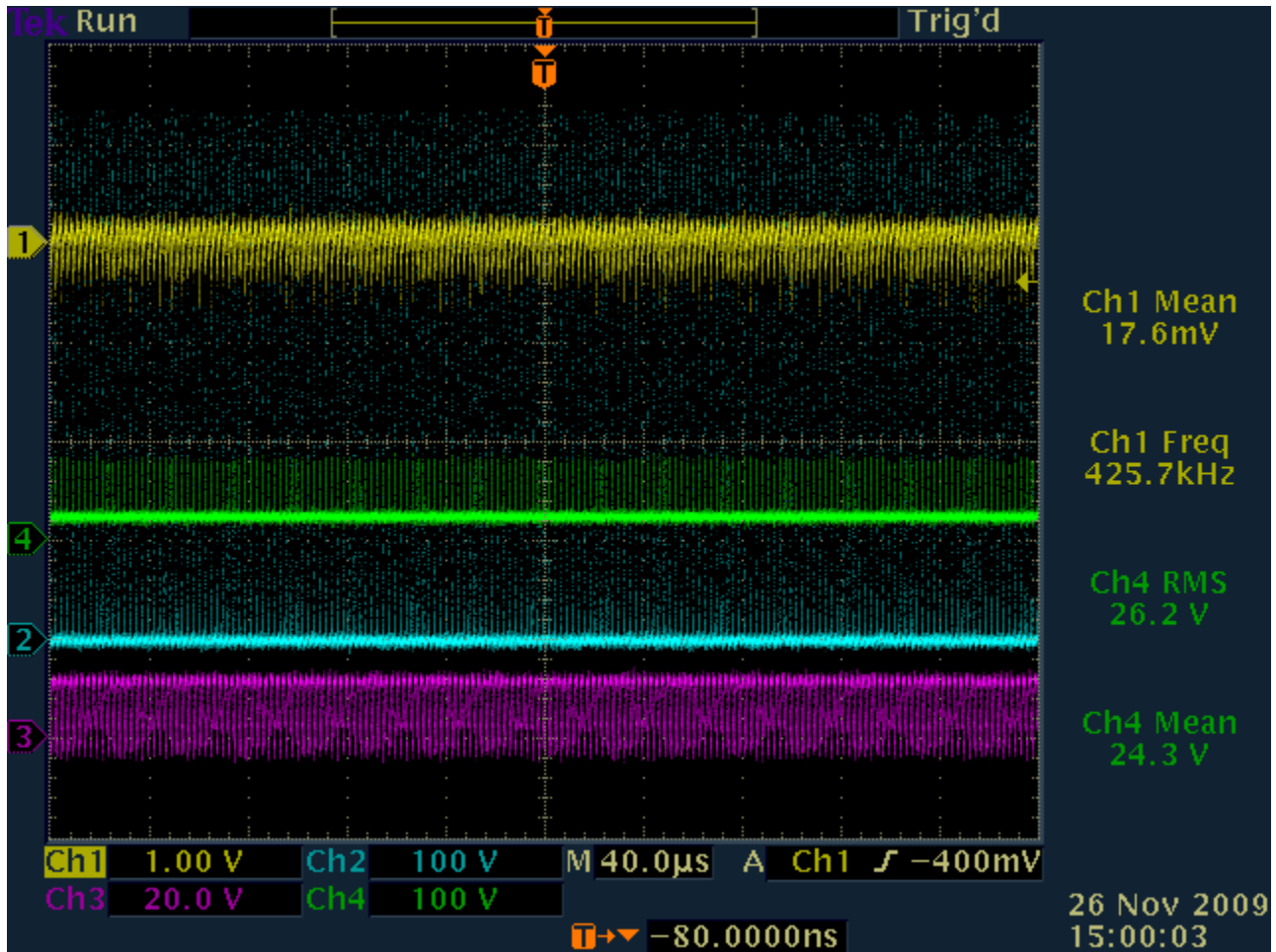

1\_2us

2\_40us

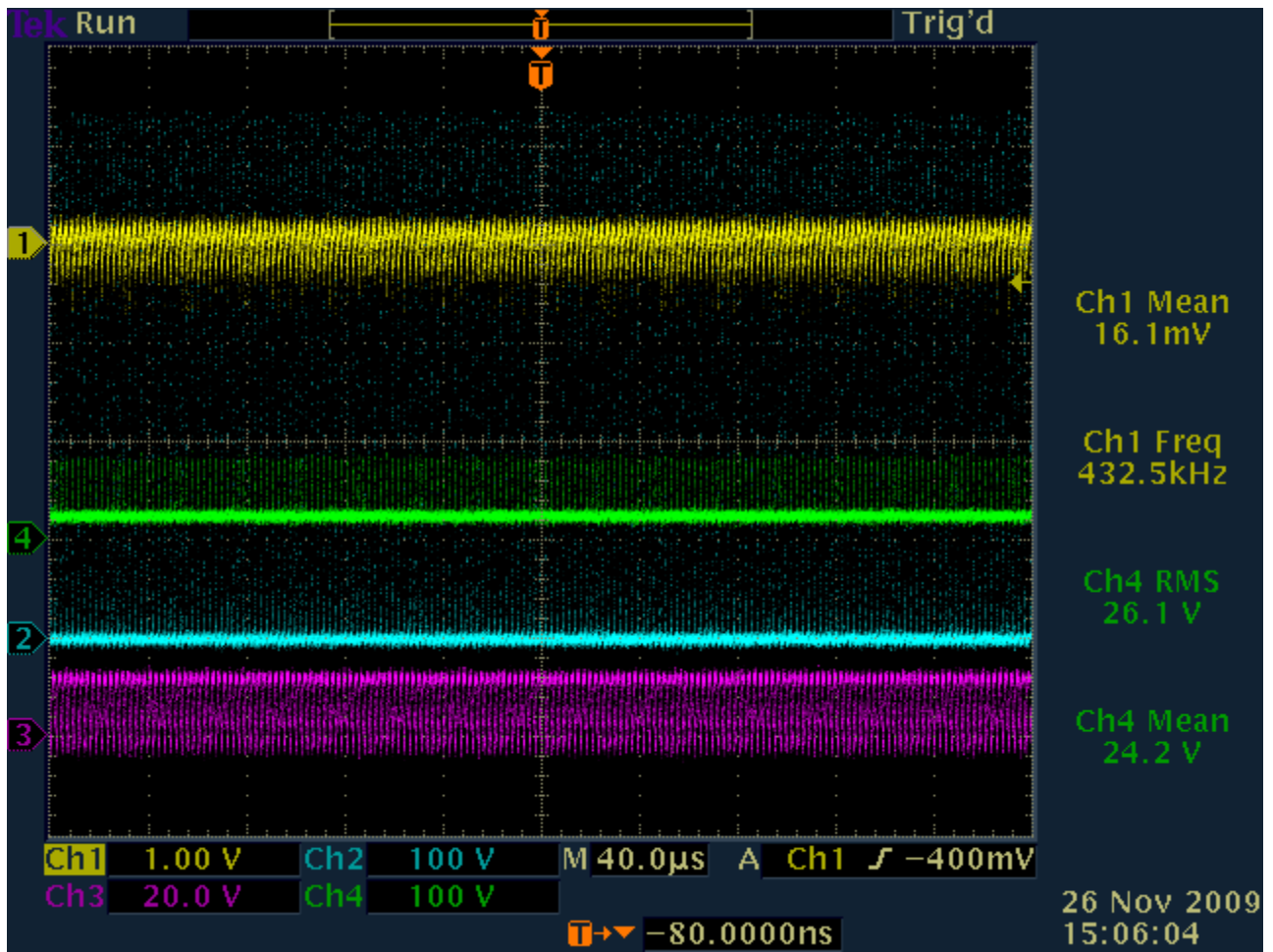

2\_2us

3\_40us



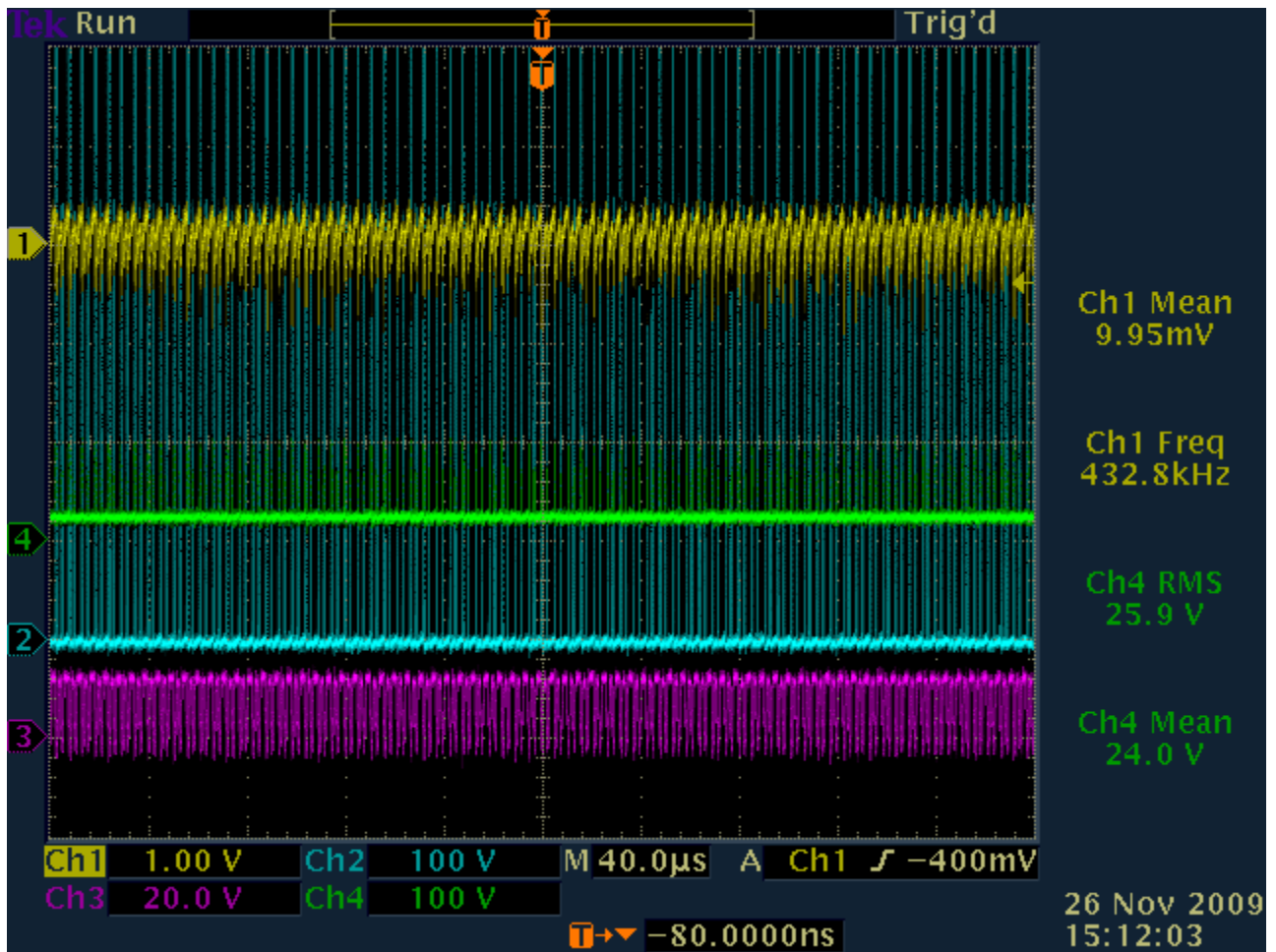

3\_2us

4\_40us

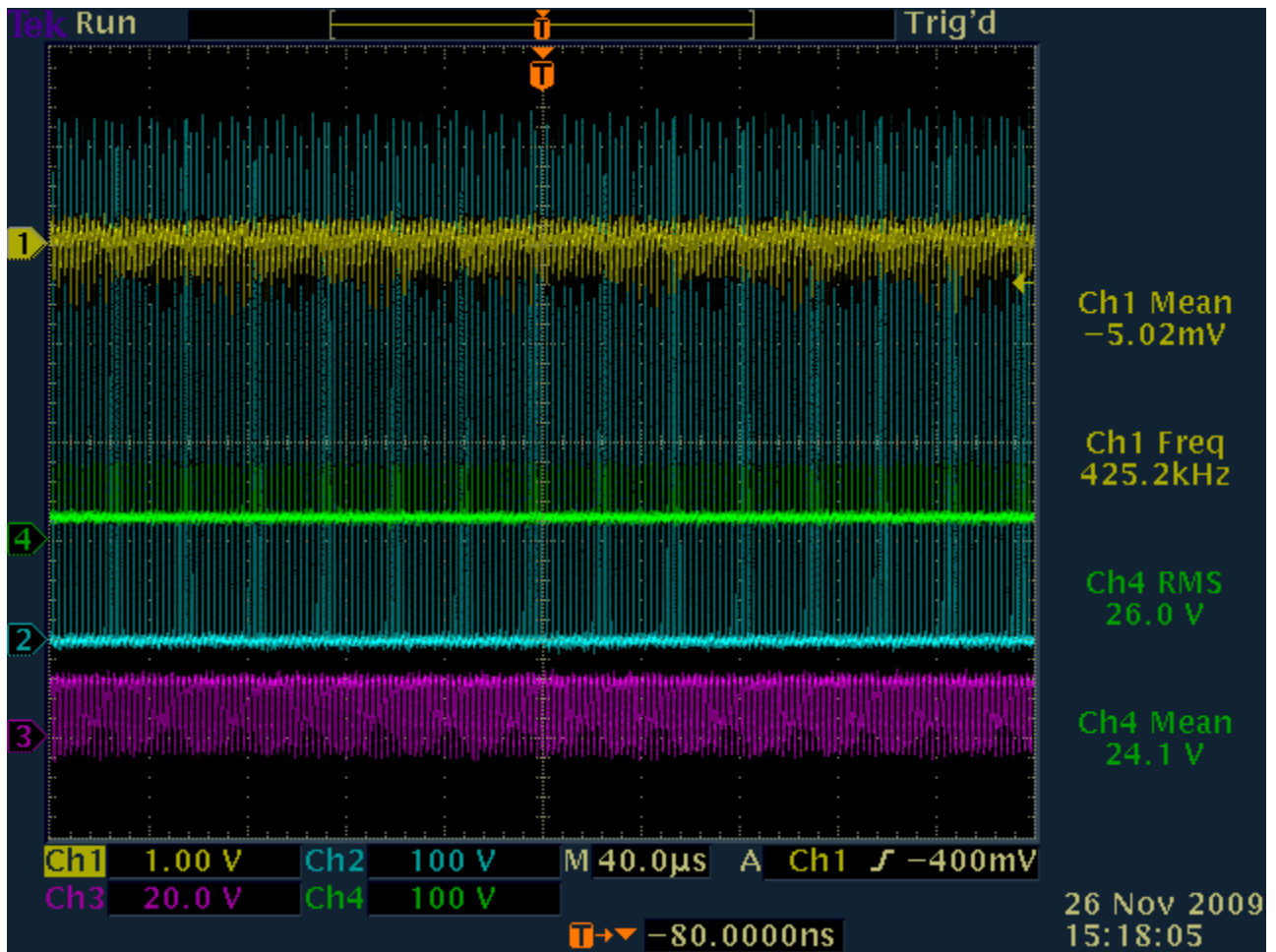

4\_2us

5\_40us

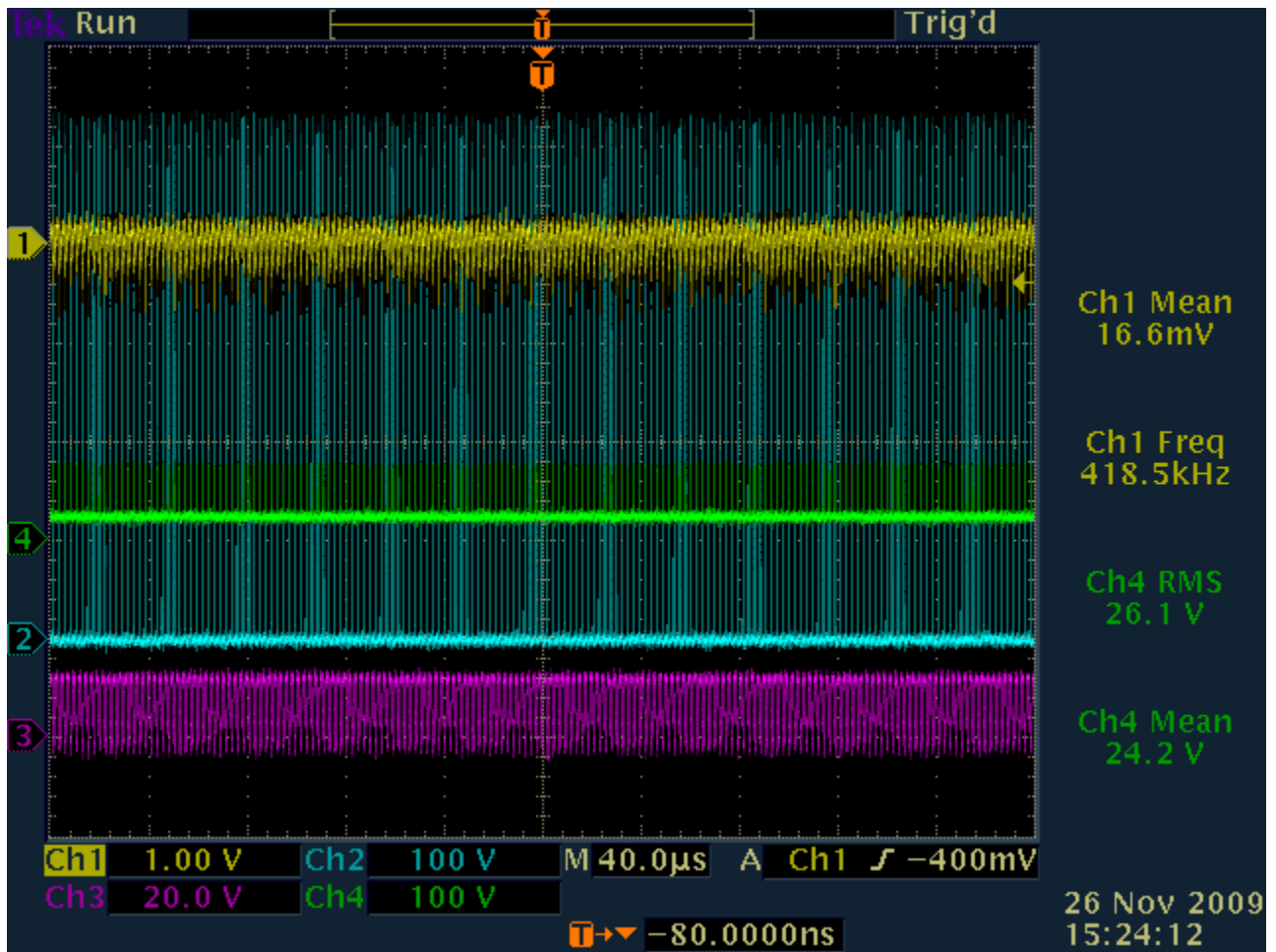

5\_2us

6\_40us

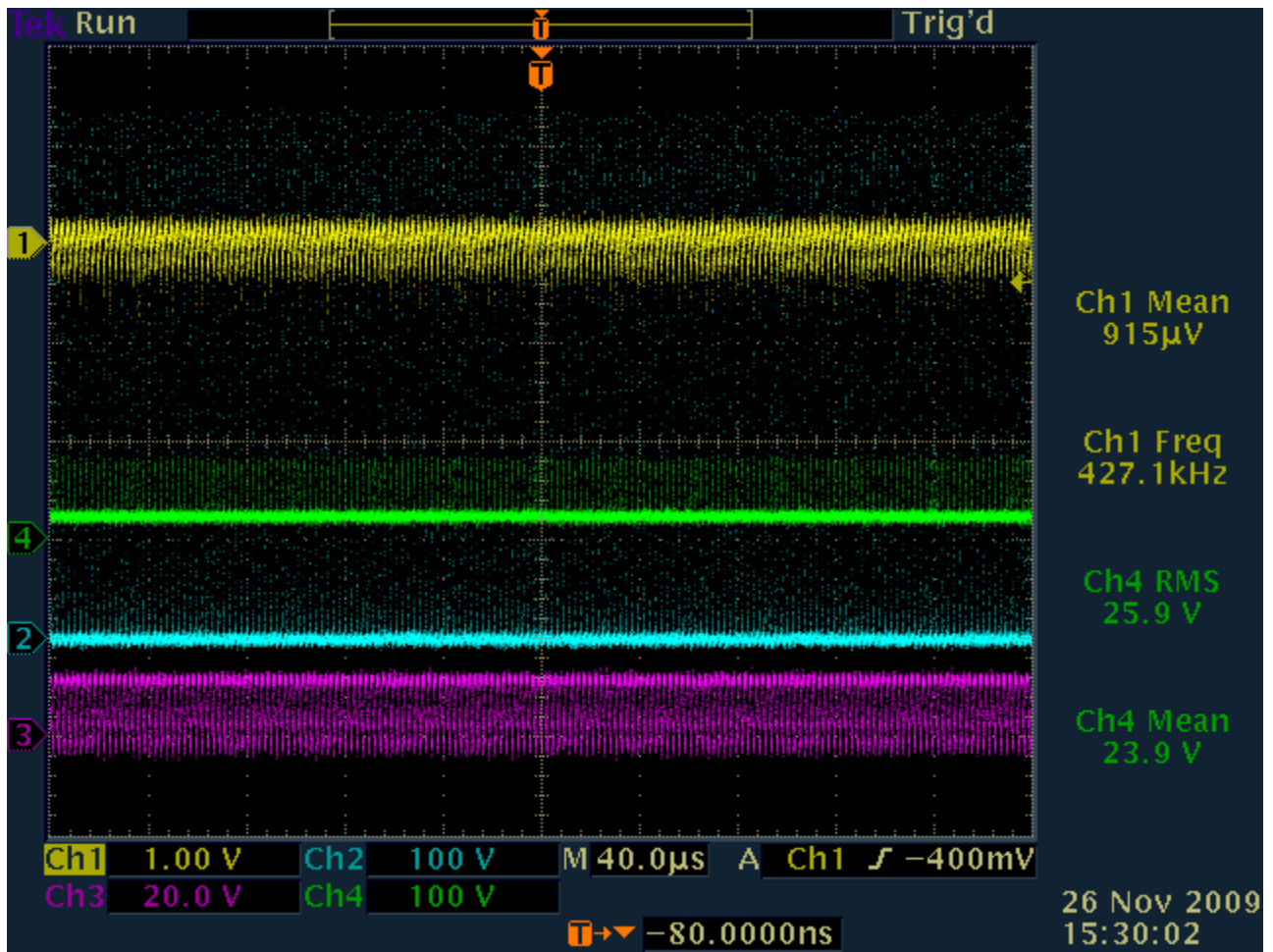

6\_2us

7\_40us

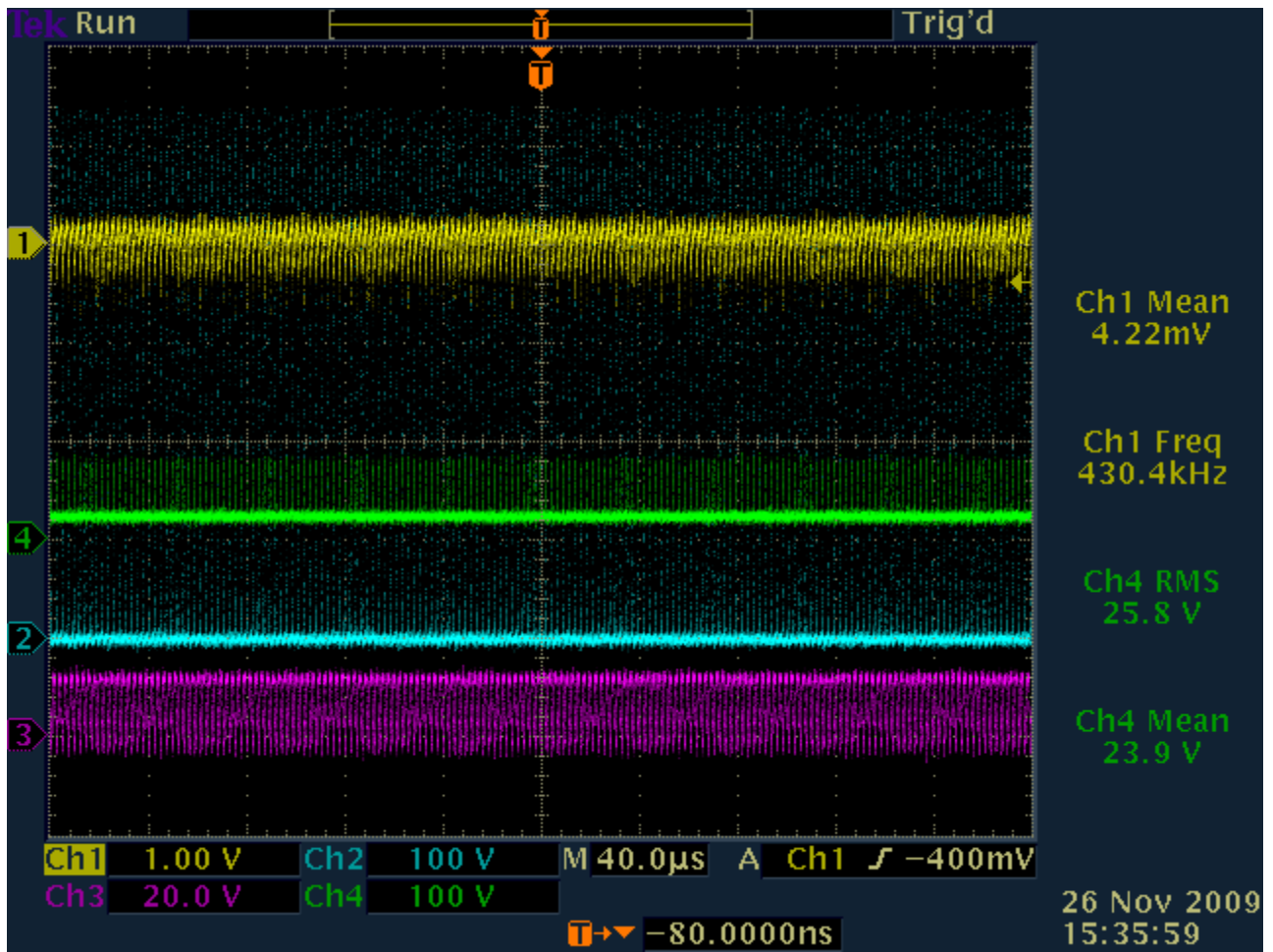

7\_2us

8\_40us

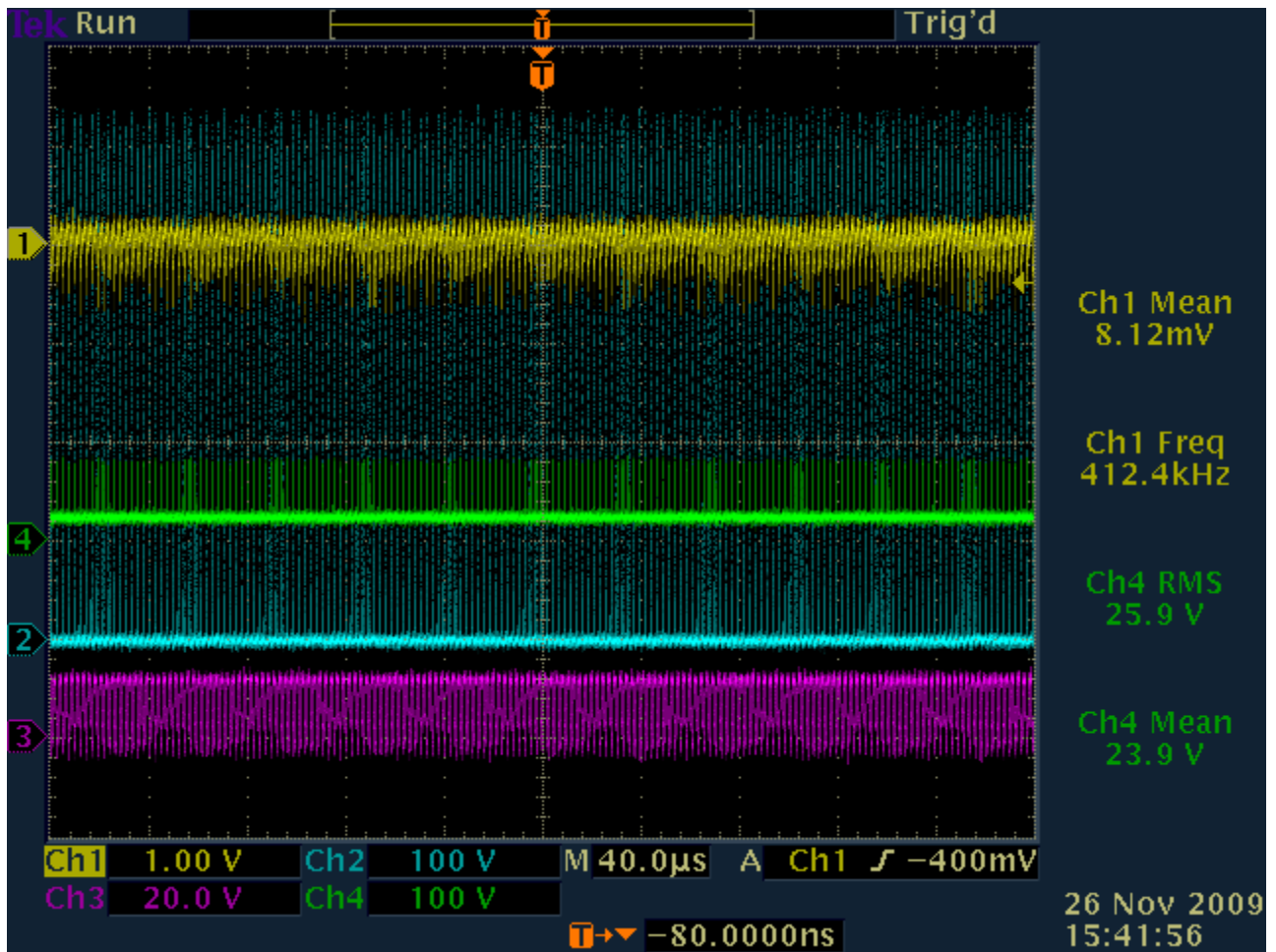

8\_2us

9\_40us

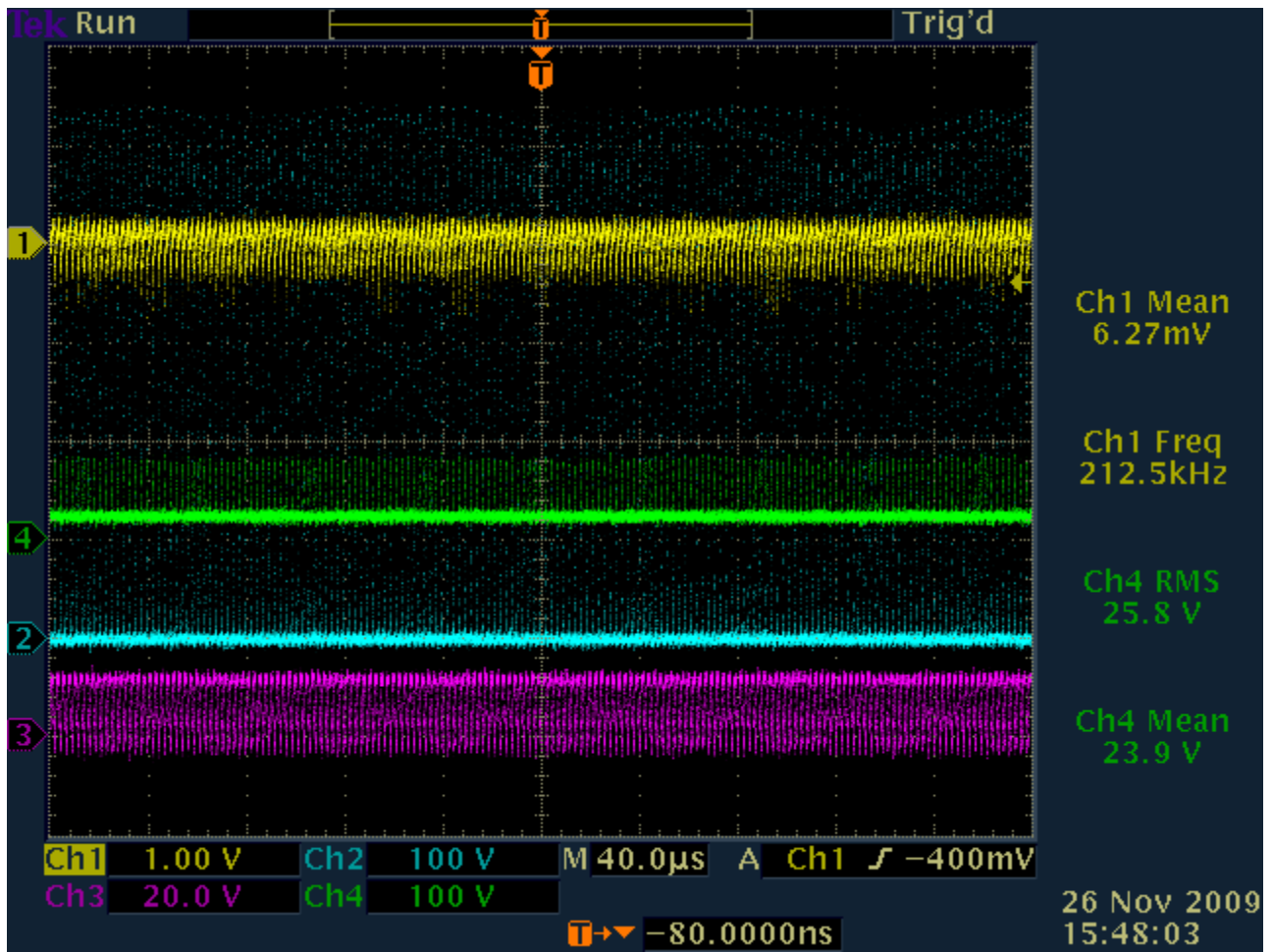

9\_2us

10\_40us

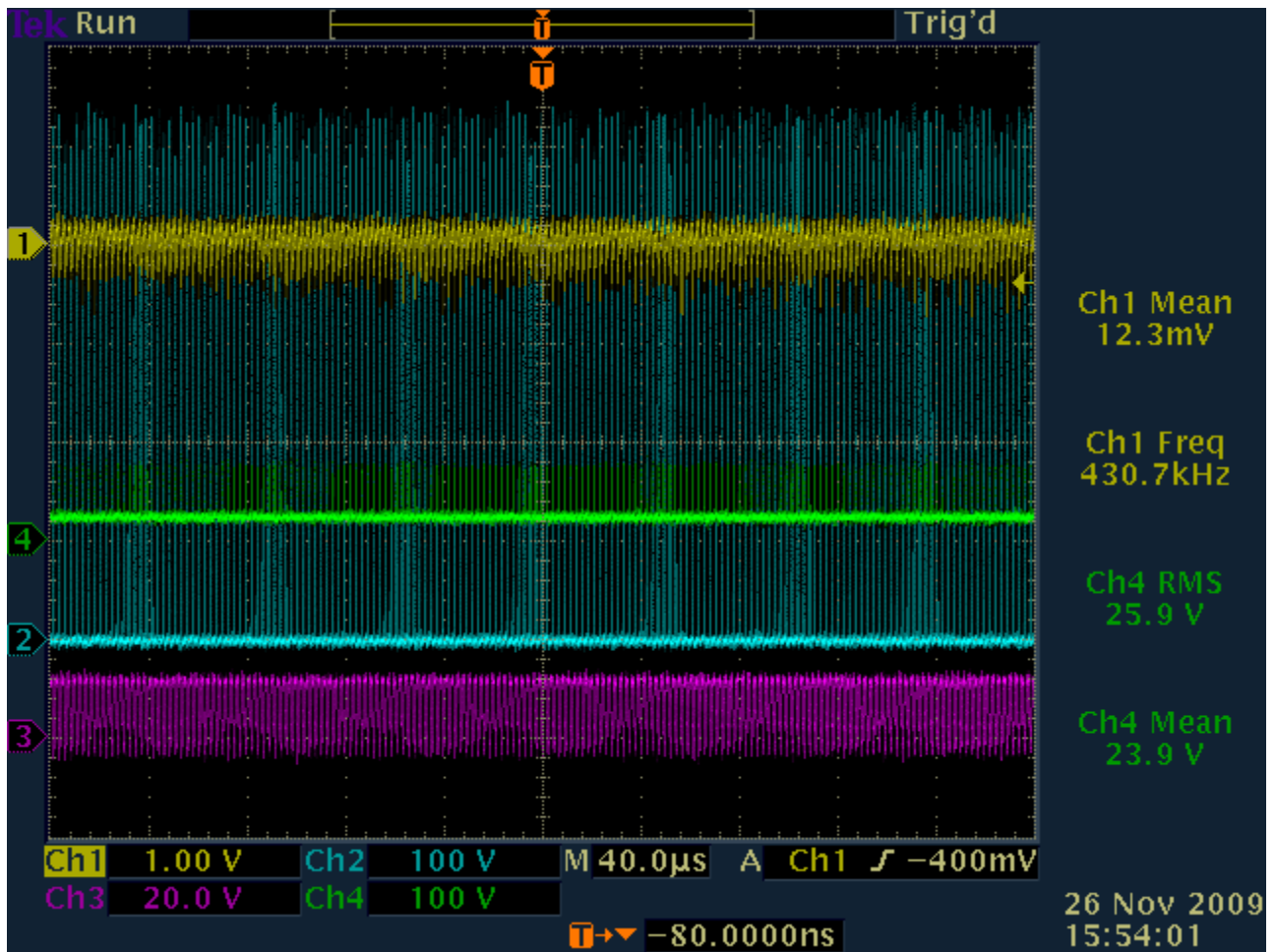

10\_2us

11\_40us



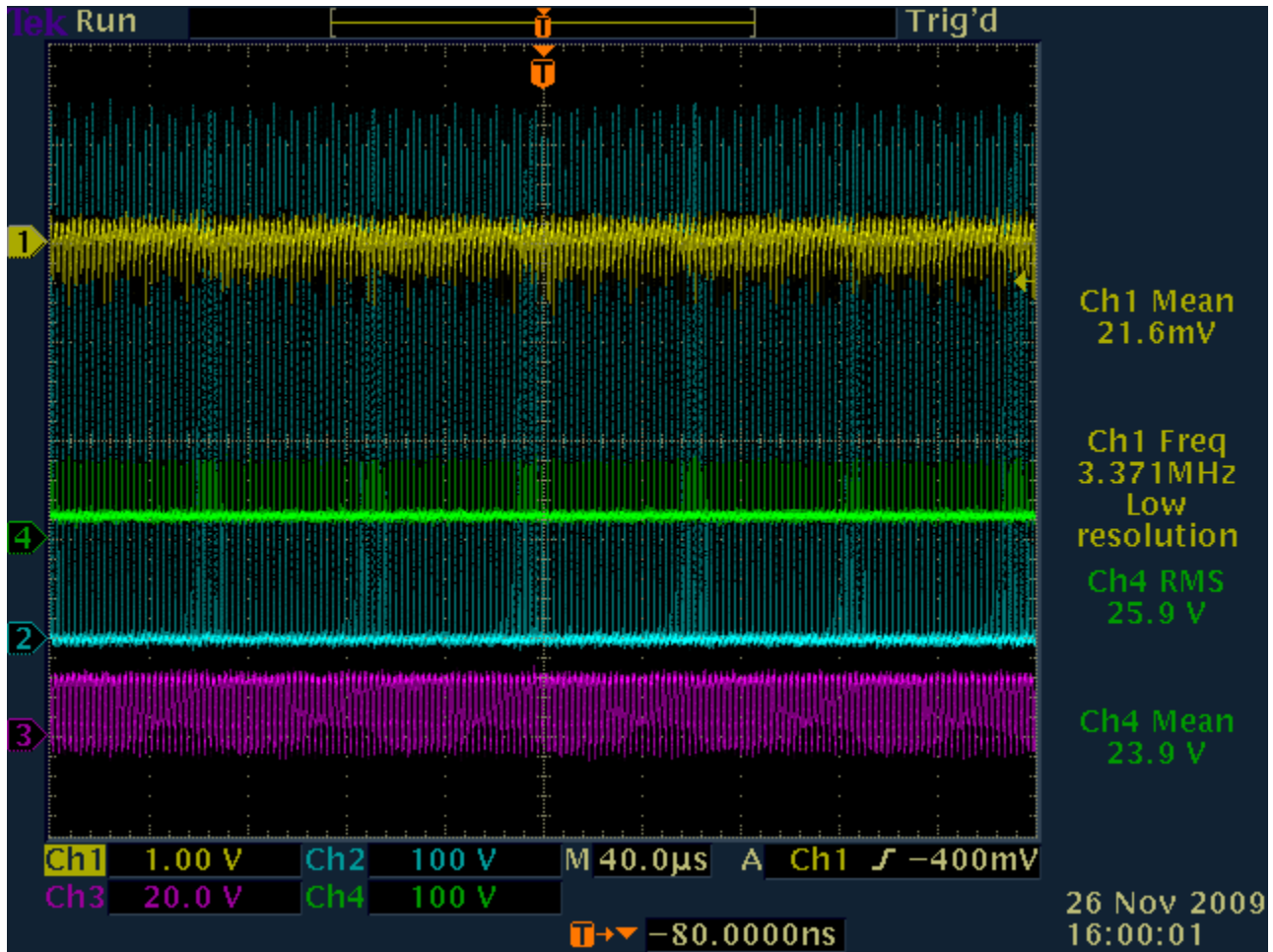

11\_2us

Thermal Data w/ Original Image Key

TEST #13  
11-26-09

1 HR X 6 MINUTE  
11 IMAGE & DATA

Prepared By	Initials	Date
Approved By		

© WILSON JONES

07508 ColumnWrite®

#	TIME	TEK CSV	TEK PNG	AMBIENT °F	LOAD DOL OF	MOSTET OF	SKUNT OF
1	15:00	40 000	000	72.8	130	161	110
	DMM 24.80	2 001	001				
2	15:06	40 002	002	72.8	137	160	107
	DMM 24.78	2 003	003				
3	15:12	40 004	004	72.9	139	161	109
	DMM 24.79	2 005	005				
4	15:18	40 006	006	72.7	140	164	110
	DMM 24.79	2 007	007				
5	15:24	40 008	008	72.6	140	165	102
	DMM 24.78	2 009	009				
6	15:30	40 010	010	72.5	139	162	112
	DMM 24.77	2 011	011				
7	15:36	40 012	012	72.5	138	161	104
	DMM 24.78	2 013	013				
8	15:42	40 014	014	72.5	138	161	107
	DMM 24.78	2 015	015				
9	15:48	40 016	016	72.5	138	162	109
	DMM 24.77	2 017	017				
10	15:54	40 018	018	72.5	137	158	114
	DMM 24.77	2 019	019				
11	16:00	40 020	020	72.5	137	156	107
	DMM 24.77	2 021	021				
	CHANNEL-1		022				
	CHANNEL-2		023				
	CHANNEL-3		024				
	CHANNEL-4		025				
	100NS		026				

100ns

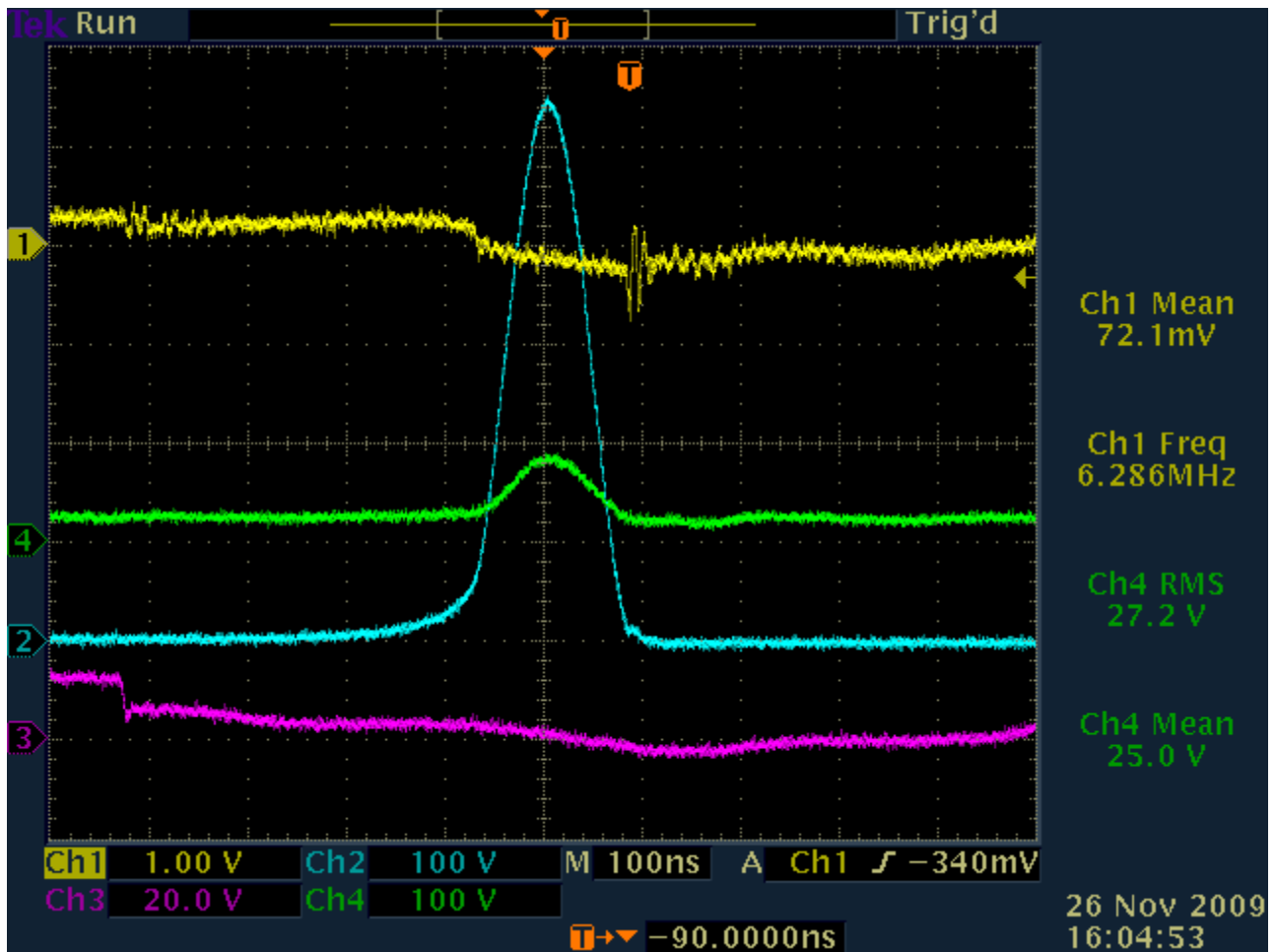

### Snap Shot Images - 2us

[Glen's Rosemary Ainslie COP>17 Heater Circuit – DATA TEST #13](#)

### Test #14

Here is TEST #14. This used an experimental 10 Ohm load resistor that is 76mm in diameter with 18 turns of #20 AWG Ni-Cr Type "A" wire with a 1mm gap spacing. This is another one (1) hour test with 40us and 10us readings taken every six (6) minutes for a total of eleven (11) readings or twenty two (22) Image and Data files for one (1) hour.

This experiment was a first time test using this "HUGE" 76mm load resistor that had marginal results and will be revisited at a later date when more time is available to see if better data can be obtained.

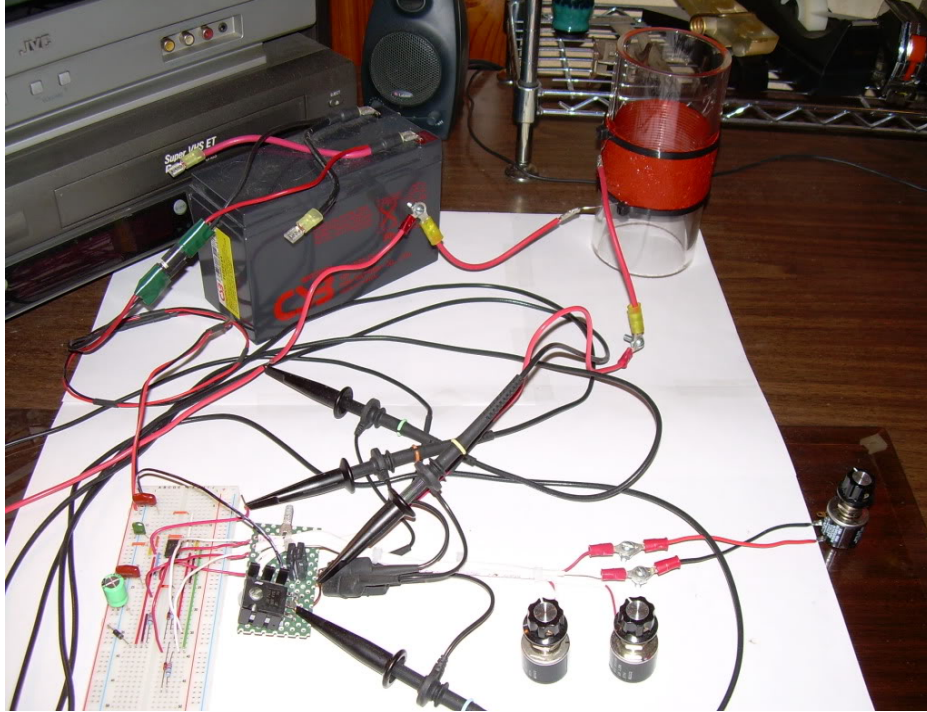

[Rosemary Ainslie COP>17 Heater Circuit](#)  
["Quantum" October 2002](#)

**Replication Components -**

- 1) [International Rectifier - IRFPG50 HEXFET® Power MOSFET](#)  
w/ Sil-Pad insulator between Mosfet and Heat Sink
- 2) [Fairchild Semiconductor - NE555N Timer](#)
- 3) [Vishay Spectrol - SP534 Precision Potentiometer/ 10-turn 2-Watt](#)
- 4) [Exide Technologies Battery "Liquid Lead Acid" Model # GT-H - TRACTOR 12V 12Ah CCA 235](#)
- 5) CSB Battery Company "Gel Lead Acid" #GP 1270 F2 / 12 Volt 7.0 Ah
- 6) Prototype 76mm Load Resister 10 ohm + - 5%
- 7) "Shunt" - Caddock High Performance Film Resistor "non-inductive" 30 watt type  
[MP930-0.25-1%](#)

**Temperature Measurements –**

Fluke 62 "mini" IR Themometer ( used maximum reading on each componenet )

**Digital Multi Meter -**

Fluke 87 DMM true RMS

**Channel 1 - Mosfet source shunt**

**Channel 2 - Mosfet drain**

**Channel 3 - 555 Timer pin #3**

**Channel 4 - 24 VDC "Liquid" Lead Acid Battery Bank**

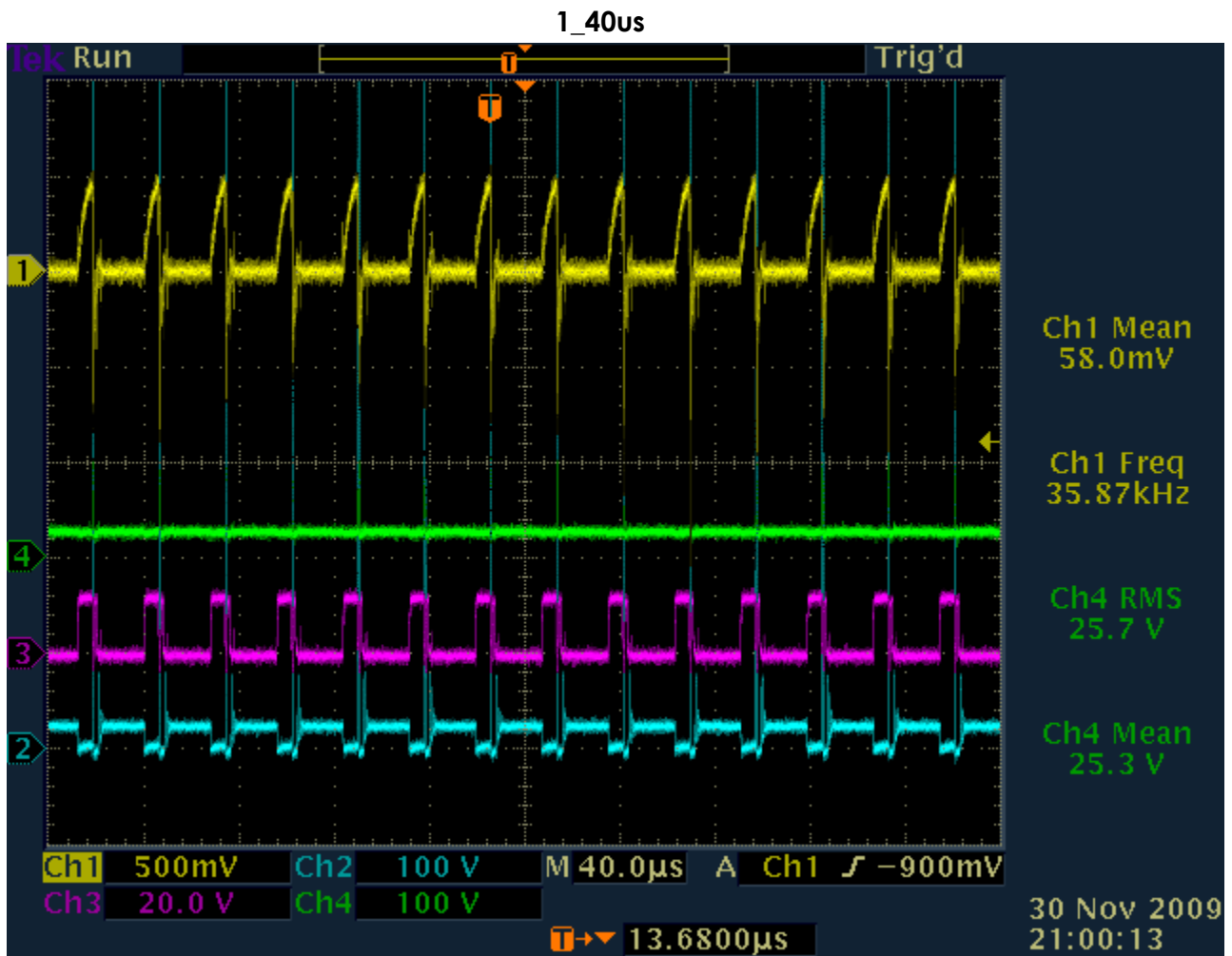

1\_10us

2\_40us

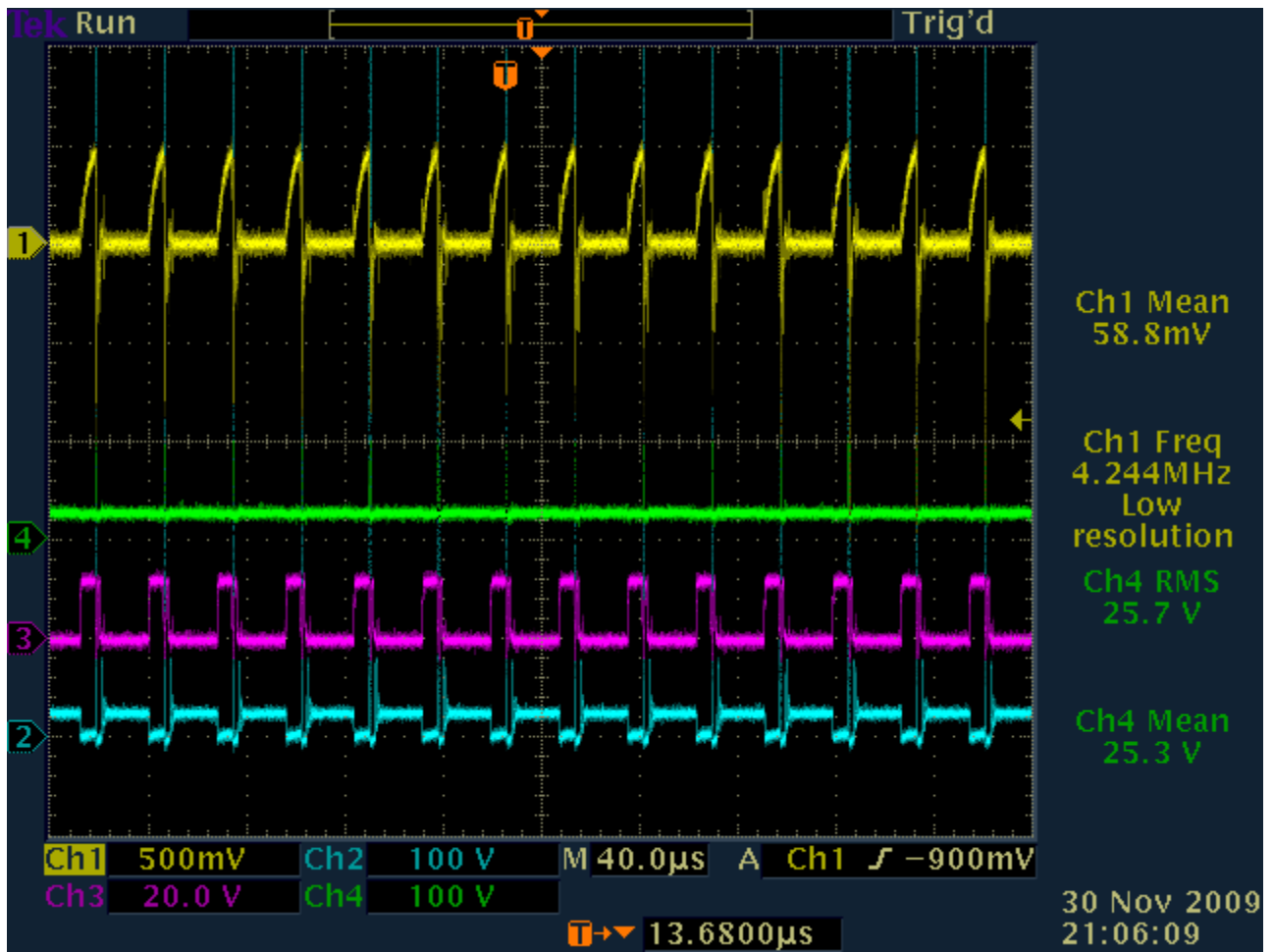

2\_10us

3\_40us

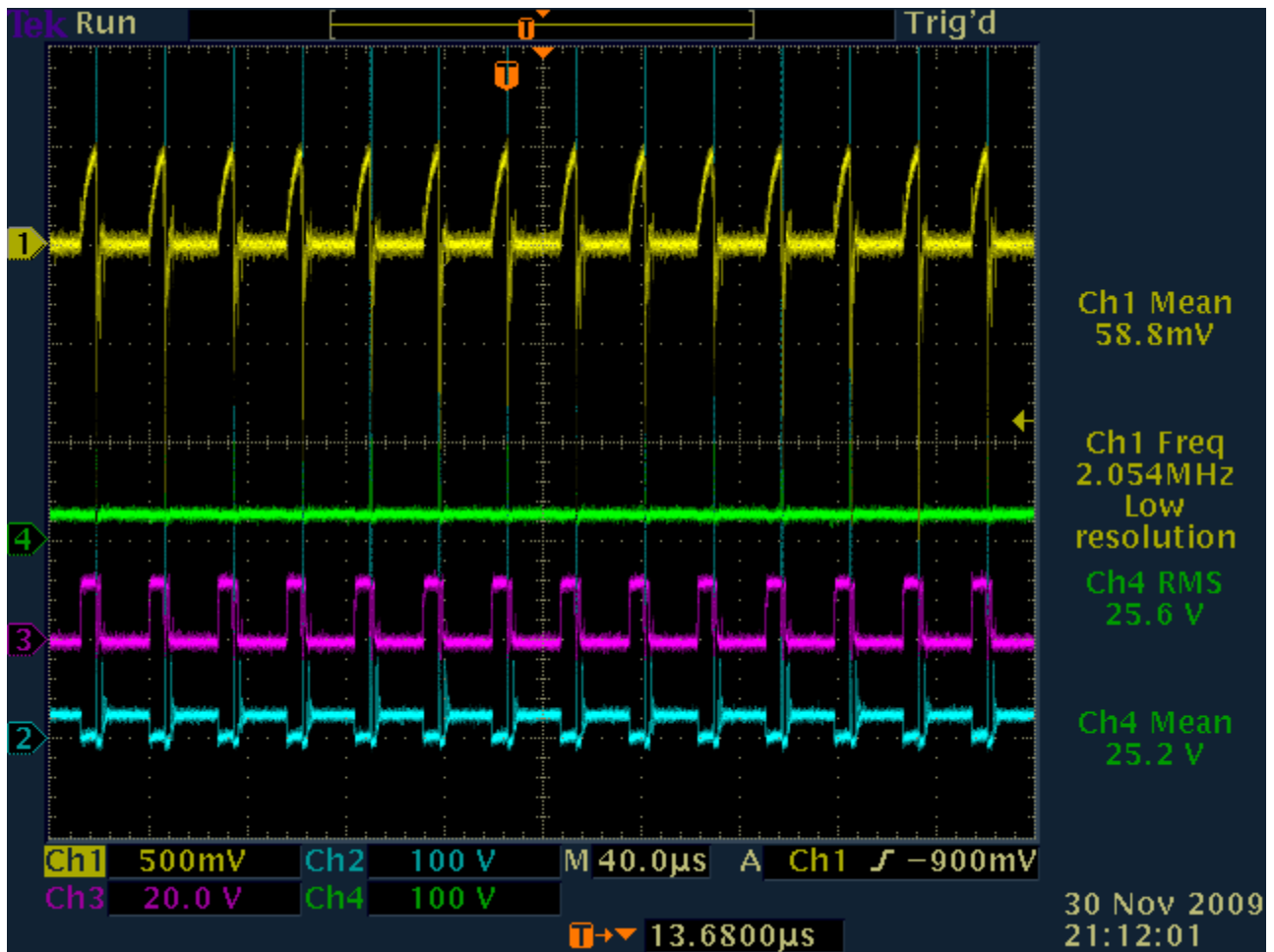

3\_10us

4\_40us

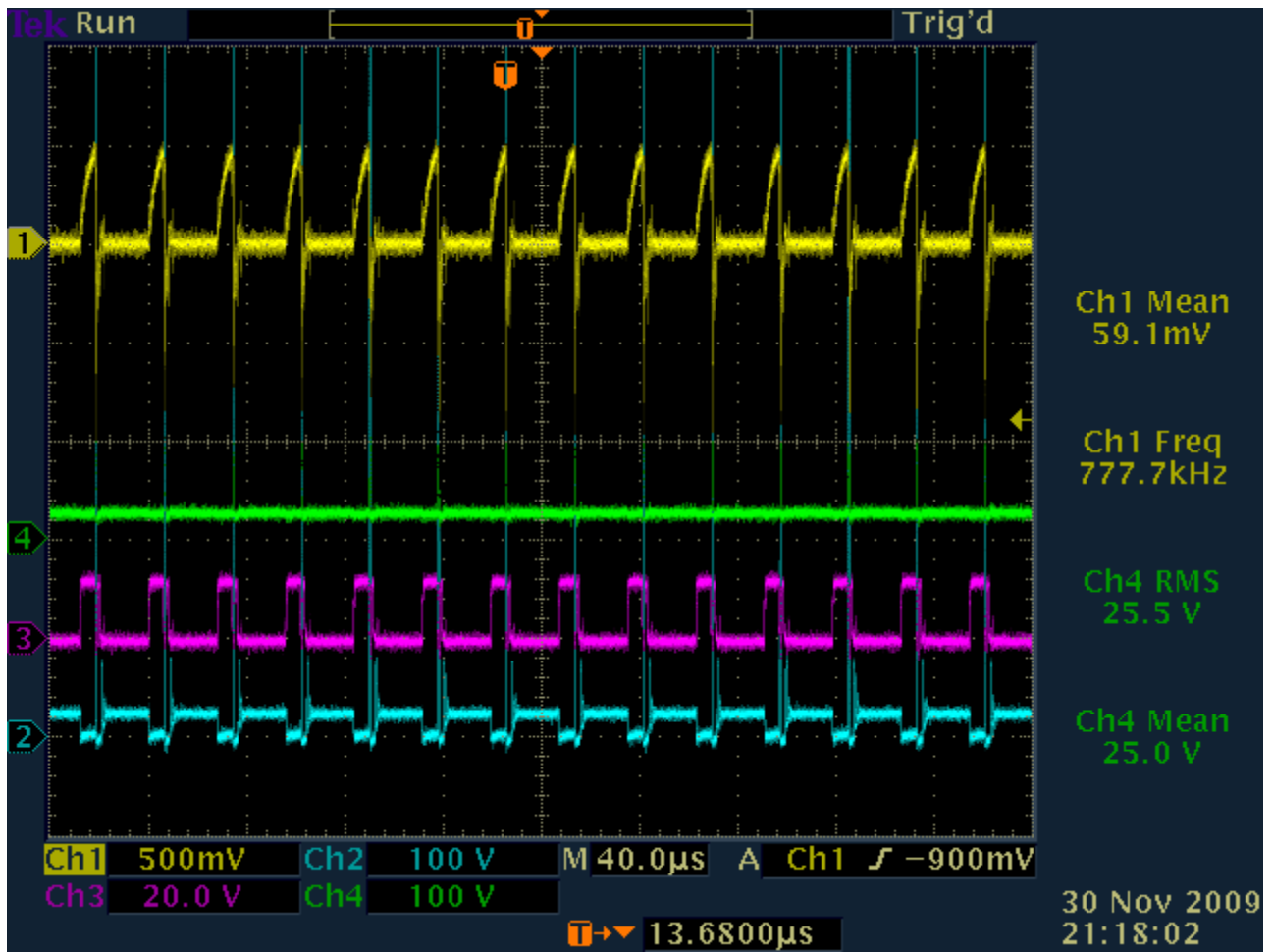

4\_10us

5\_40us



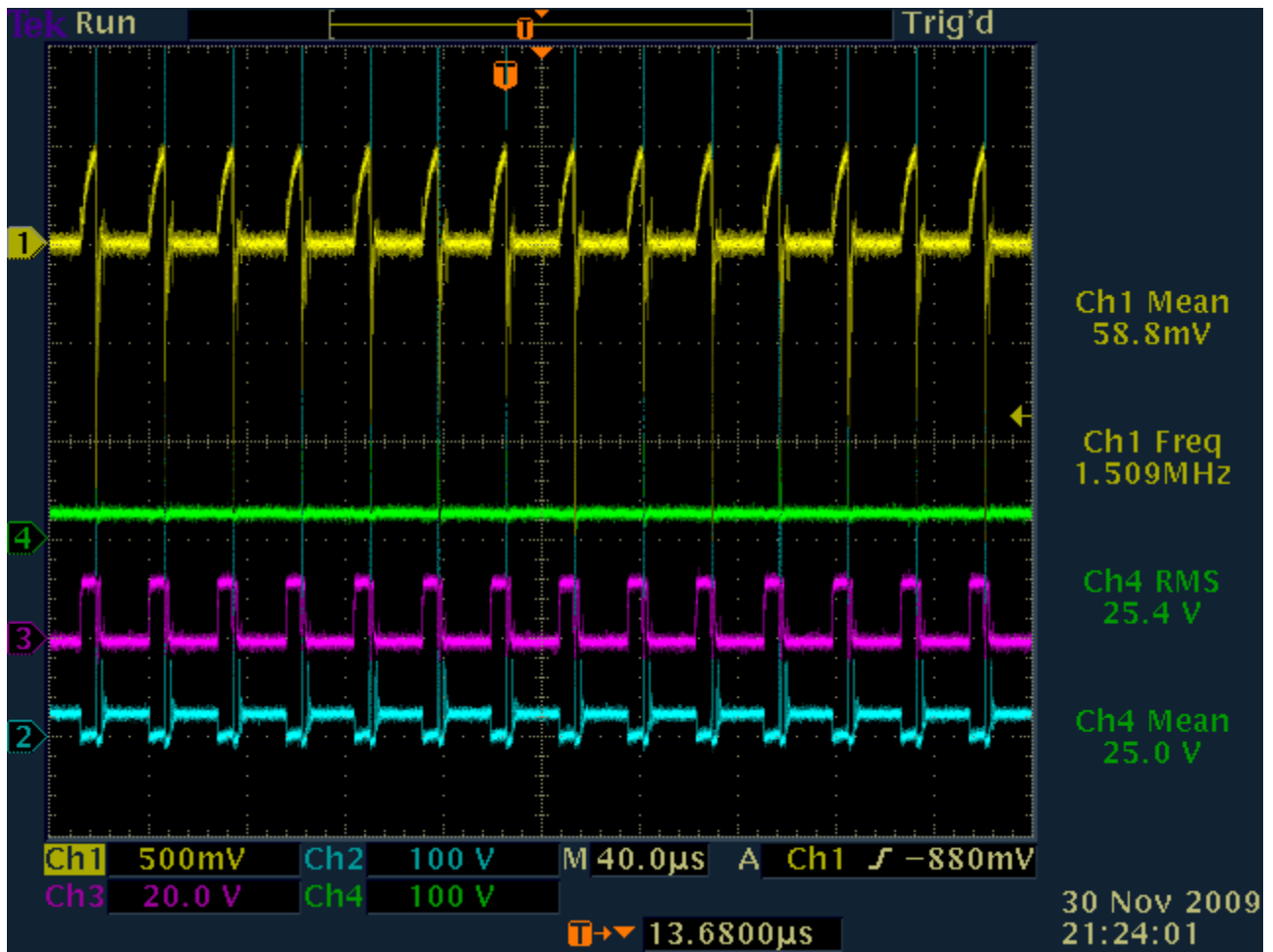

5\_10us

6\_40us

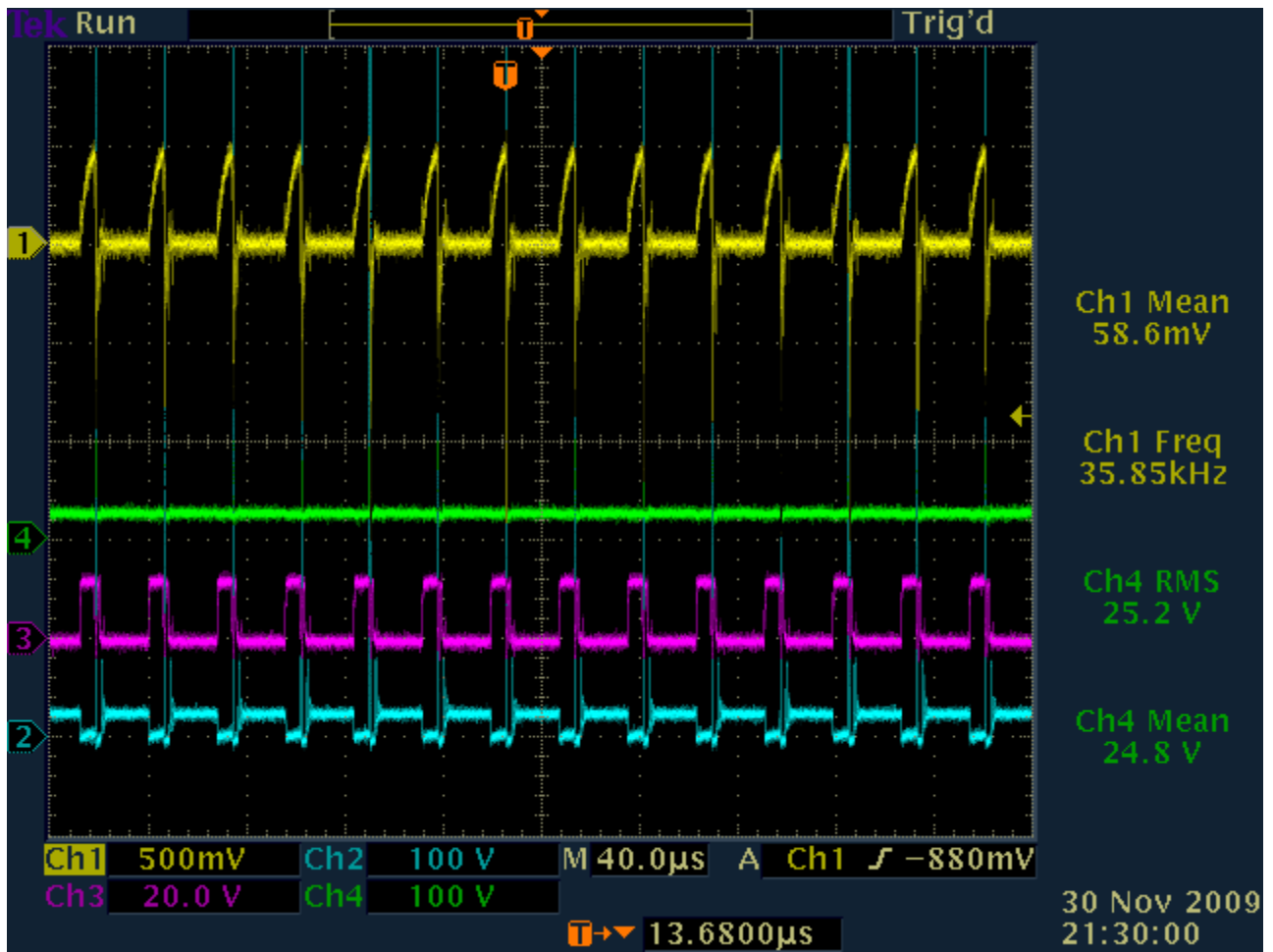

6\_10us

7\_40us

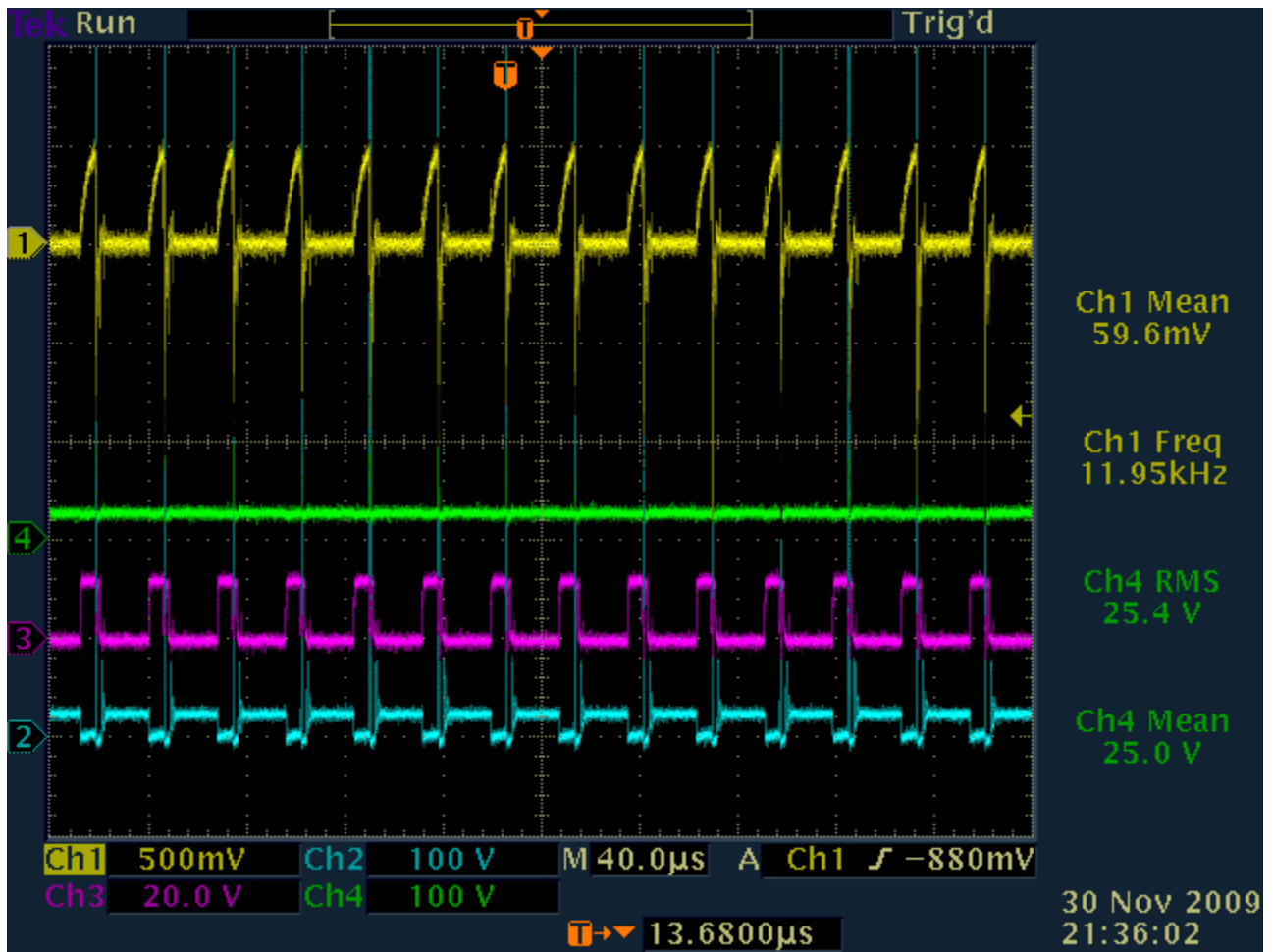

7\_10us

8\_40us

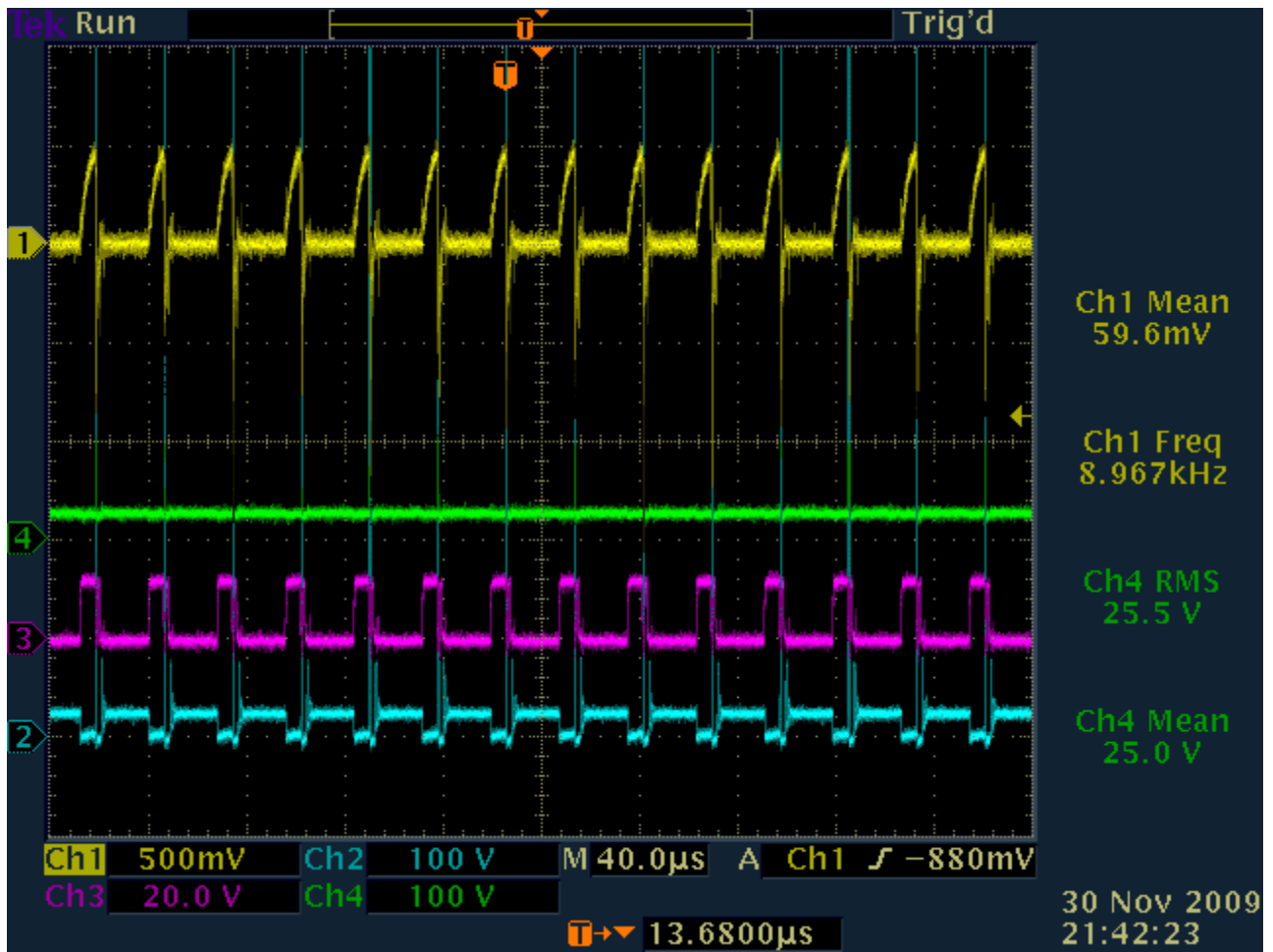

8\_10us

9\_40us

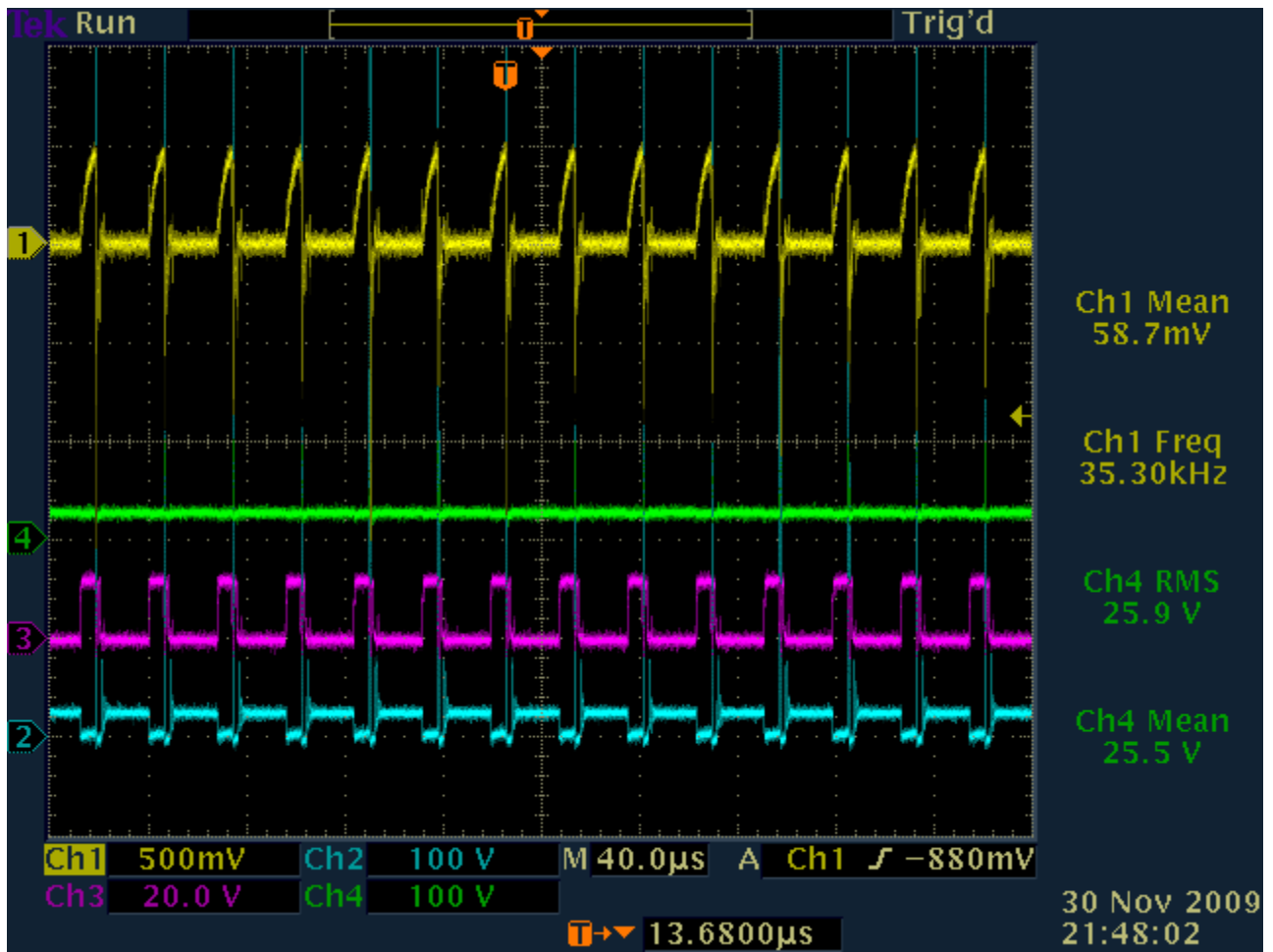

9\_10us

10\_40us

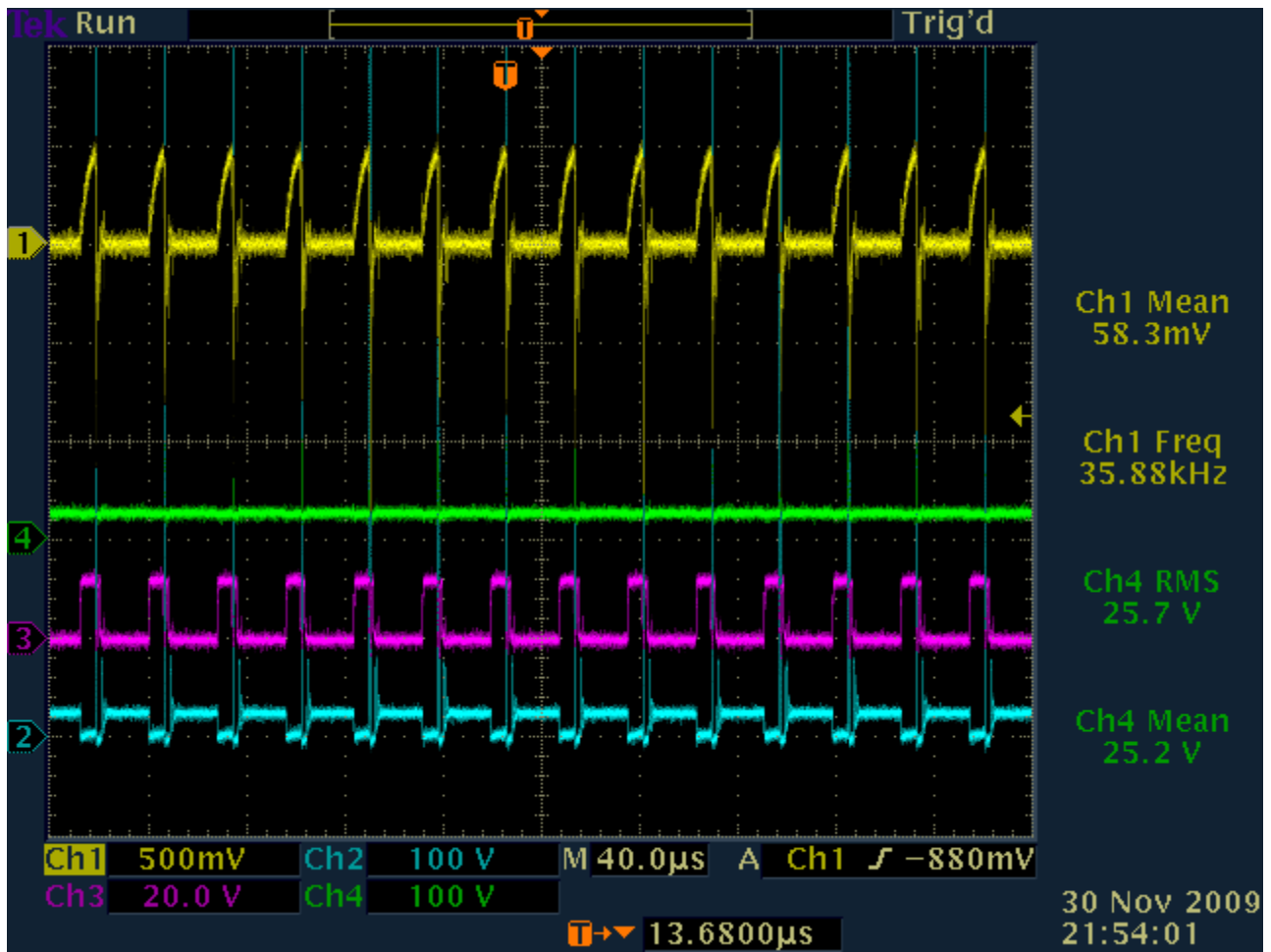

10\_10us

11\_40us

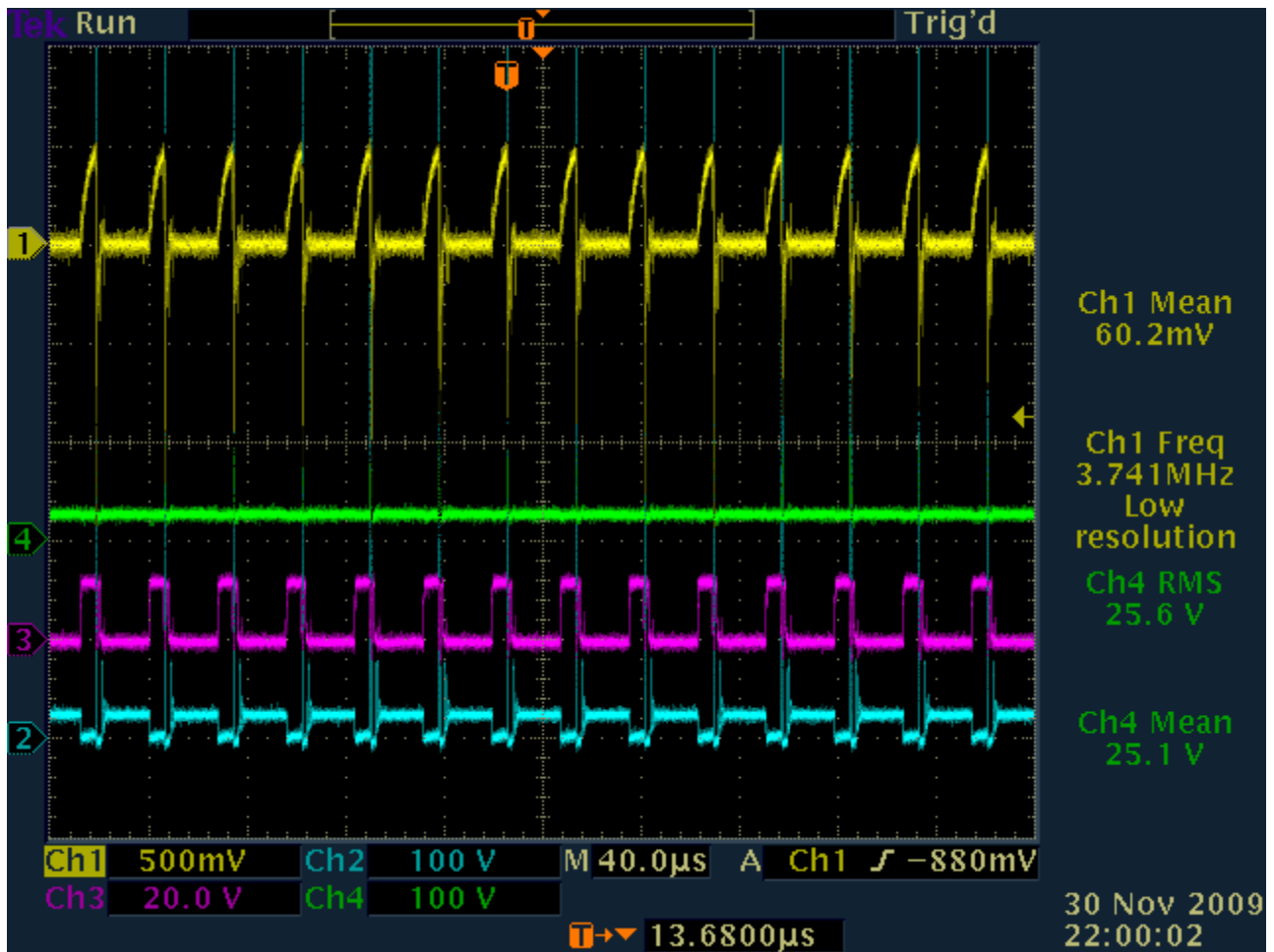

11\_10us

Thermal Data w/ Key

TEST #14  
11-30-09

"76MM"  
1 HR X 6 MINUTE  
IMAGE & DATA

Initials \_\_\_\_\_ Date \_\_\_\_\_  
Prepared By \_\_\_\_\_  
Approved By \_\_\_\_\_

#	TIME	TEK CSV	TEK PNG	AMBIENT °F	LOAD LOJ °F	MOSPET °F	SHUTT °F
1	21:06	40 000	000	74.2	113	138	100
	DMM 25.03	10 001	001				
2	21:06	40 002	002	74.2	113	137	100
	DMM 25.03	10 003	003				
3	21:12	40 004	004	74.1	112	136	102
	DMM 25.03	10 005	005				
4	21:18	40 006	006	73.9	112	136	98
	DMM 25.02	10 007	007				
5	21:24	40 008	008	73.9	112	135	100
	DMM 25.02	10 009	009				
6	21:30	40 010	010	73.9	112	135	103
	DMM 25.02	10 011	011				
7	21:36	40 012	012	73.8	112	134	99
	DMM 25.01	10 013	013				
8	21:42	40 014	014	73.8	112	136	101
	DMM 25.01	10 015	015				
9	21:48	40 016	016	74.0	112	136	98
	DMM 25.00	10 017	017				
10	21:54	40 018	018	74.0	113	134	99
	DMM 25.00	10 019	019				
11	22:00	40 020	020	74.0	113	136	101
	DMM 25.00	10 021	021				
	CHANNEL - 1		022				
	" 2		023				
	" 3		024				
	" 4		025				
	100NS		026				
	2US		027				



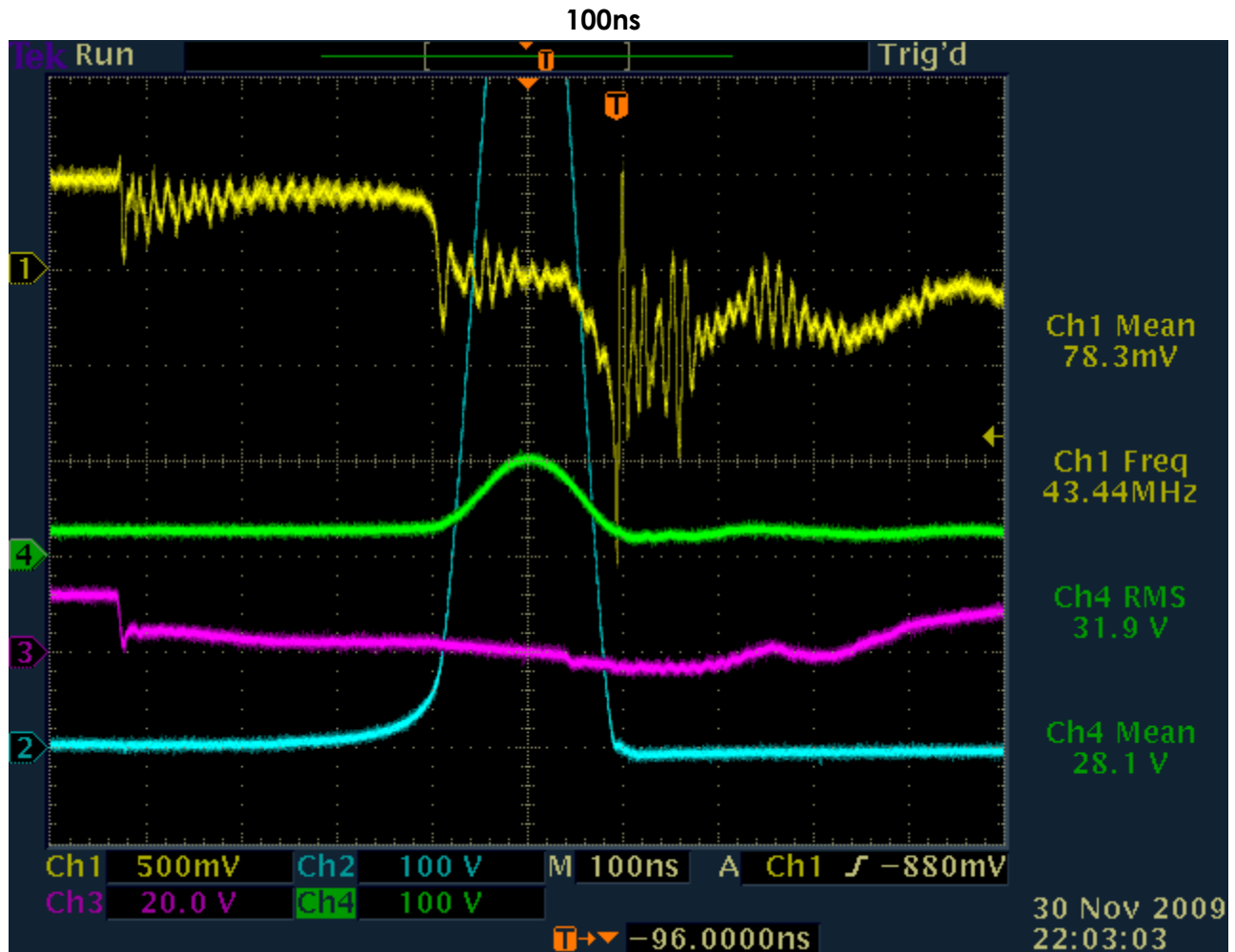

**Closing comments by Rose** -The experiment that Fuzzy has completed shows that it's theoretically possible to run the average household heating requirements at anything up to and less than 75% of the current that you normally use. This also means that you can reduce your electricity bill by this amount. And also, it means that theoretically, we could reduce global carbon pollution that results from the way we're using electricity, by at least that amount. In fact, with fine tuning, we are not sure of the upper levels of efficiency that can be reached. But the numbers seem to get better with each test.

The problem is that we needed to prove this which meant that Fuzzy's measurements had to be accurate. Tektronix rallied and we were privileged to use their TDS3054C DPO which, as Fuzzy describes it, - is to measuring - what a Ferrari is to driving. Brilliant and perfect. But all oscilloscopes have a limit in the voltages they can measure. This meant that tests had to be kept to 'smallish values'. So. Nothing was tested at really high values. But enough was evidenced to show 'proof of concept'.

**In other words, plenty research still needs to be done. This especially relates to the kind**

**of heating elements which are needed** - and the way to make those elements 'resonate' - which is tricky. But notwithstanding this, the facts are that there is early and unequivocal evidence that we can use electricity very much more economically than we are doing at present. Which is good news, as mentioned, both for the pocket and for the planet.

The down side is that these results are not really 'allowed' in terms of classical and quantum physics. It's to do with the laws that state - you can only get out what you put in. Something like that. They're known as Thermodynamic Laws and they've been in force and effect since the days of Newton. So. Our academics are justifiably skeptical. In fact they have entirely disassociated themselves from these tests and these claims for upwards of 10 years. We have repeatedly tried to bring them demonstrations and submitted papers that were rejected outright. But we're hoping that this 'open source' application may carry more justification for review as it's sort of 'public'.

The other thing of interest is that academics may need to revisit those thermodynamic laws. There are plenty of competing theories that account for this 'effect'. But I'm reasonably sure that our learned and revered will come up with an explanation that somehow reconciles these anomalies.

I'm writing this in the hopes that it'll explain the position better to our lay public - and hope this helps clarify things. And Harvey, Fuzzy, anybody, if I've left out anything critical please do your thing here.

### **Test #15**

This is a re-test of the experimental 10 Ohm load resistor that is 76mm Outside Diameter with 18 turns of #20 AWG Ni-Cr Type "A" wire with 1mm gap spacing. The 76mm Borosilicate Tubing has a inside diameter of 66.5mm so the wall thickness is 4.75mm or about 3/16" inches ( a lot to heat ) and will have to do a resistor "thermo profile" to see what the actual results are. This is another one (1) hour test with 40us and 2us readings taken every six (6) minutes for a total of eleven (11) readings or twenty two (22) Image and Data files for one (1) hour. This experiment was the second time testing the "HUGE" 76mm load resistor with a smaller 10 Ohm 100 watt "Wire Wound" resistor with a GE #T464 28 volt lamp connected for tuning, varying in brightness at different frequencies.

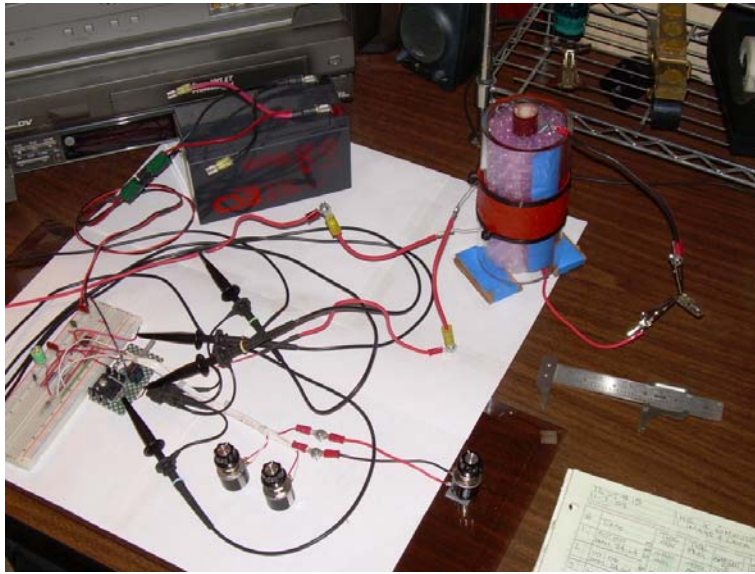

[Test15 Resistor Set-up 12-07-09.jpg Image File](#)  
[Rosemary Ainslie COP>17 Heater Circuit](#)  
["Quantum" October 2002](#)

### **Replication Components -**

- 1) [International Rectifier - IRFPG50 HEXFET® Power MOSFET](#)  
w/ Sil-Pad insulator between Mosfet and Heat Sink
- 2) [Fairchild Semiconductor - NE555N Timer](#)
- 3) [Vishay Spectrol - SP534 Precision Potentiometer/ 10-turn 2-Watt](#)
- 4) [Exide Technologies Battery "Liquid Lead Acid" Model # GT-H - TRACTOR 12V 12Ah CCA 235](#)
- 5) CSB Battery Company "Gel Lead Acid" #GP 1270 F2 / 12 Volt 7.0 Ah
- 6) Prototype 76mm Load Resistor 10 ohm + - 5%
- 7) "Shunt" - Caddock High Performance Film Resistor "non-inductive" 30 watt type  
[MP930-0.25-1%](#)

### **Temperature Measurements -**

Fluke 62 "mini" IR Thermometer ( used maximum reading on each component )

### **Digital Multi Meter -**

Fluke 87 DMM true RMS  
Channel 1 - Mosfet source shunt  
Channel 2 - Mosfet drain  
Channel 3 - 555 Timer pin #3  
Channel 4 - 24 VDC "Liquid" Lead Acid Battery Bank

1\_40us

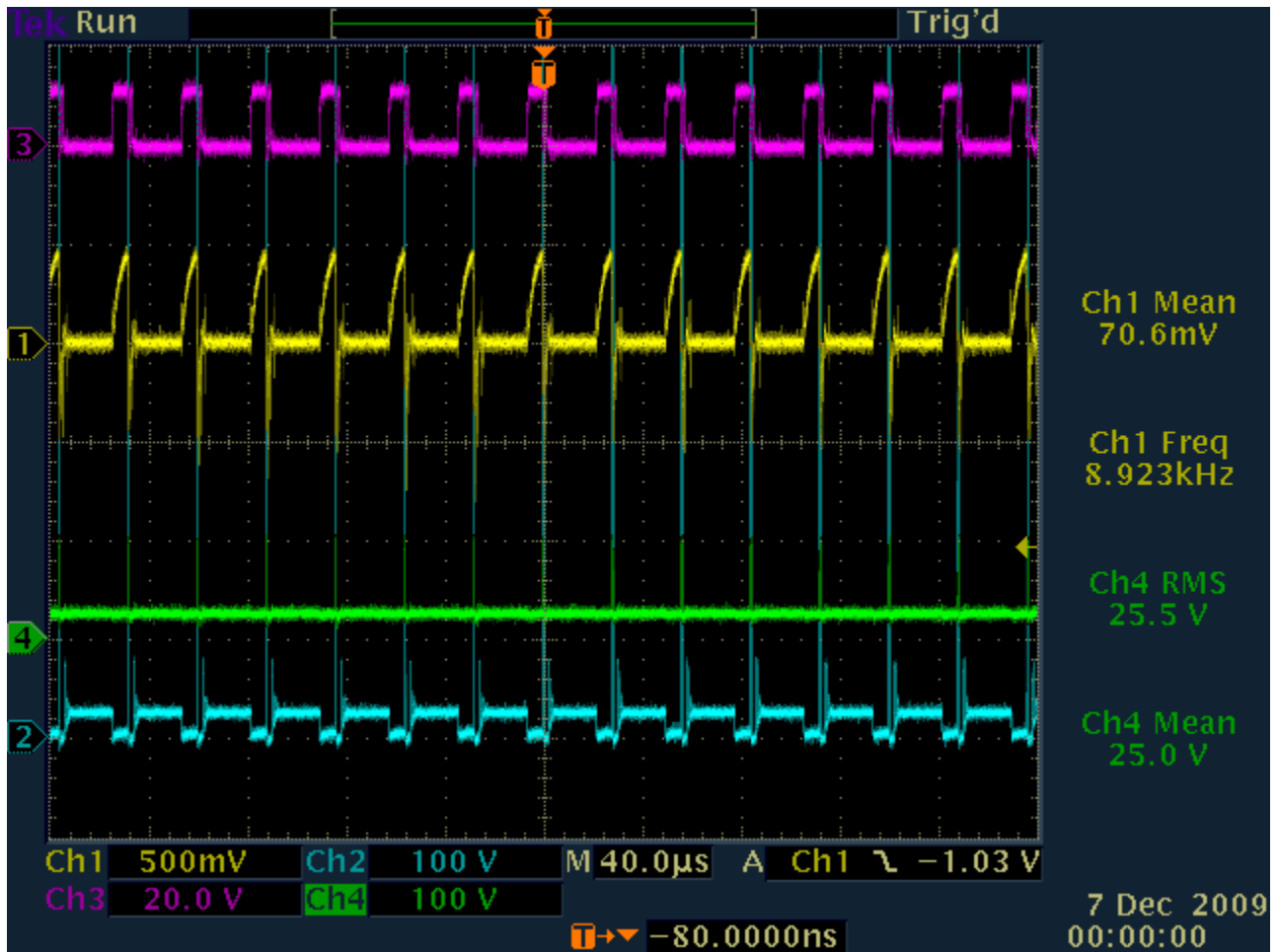

1\_20us

2\_40us

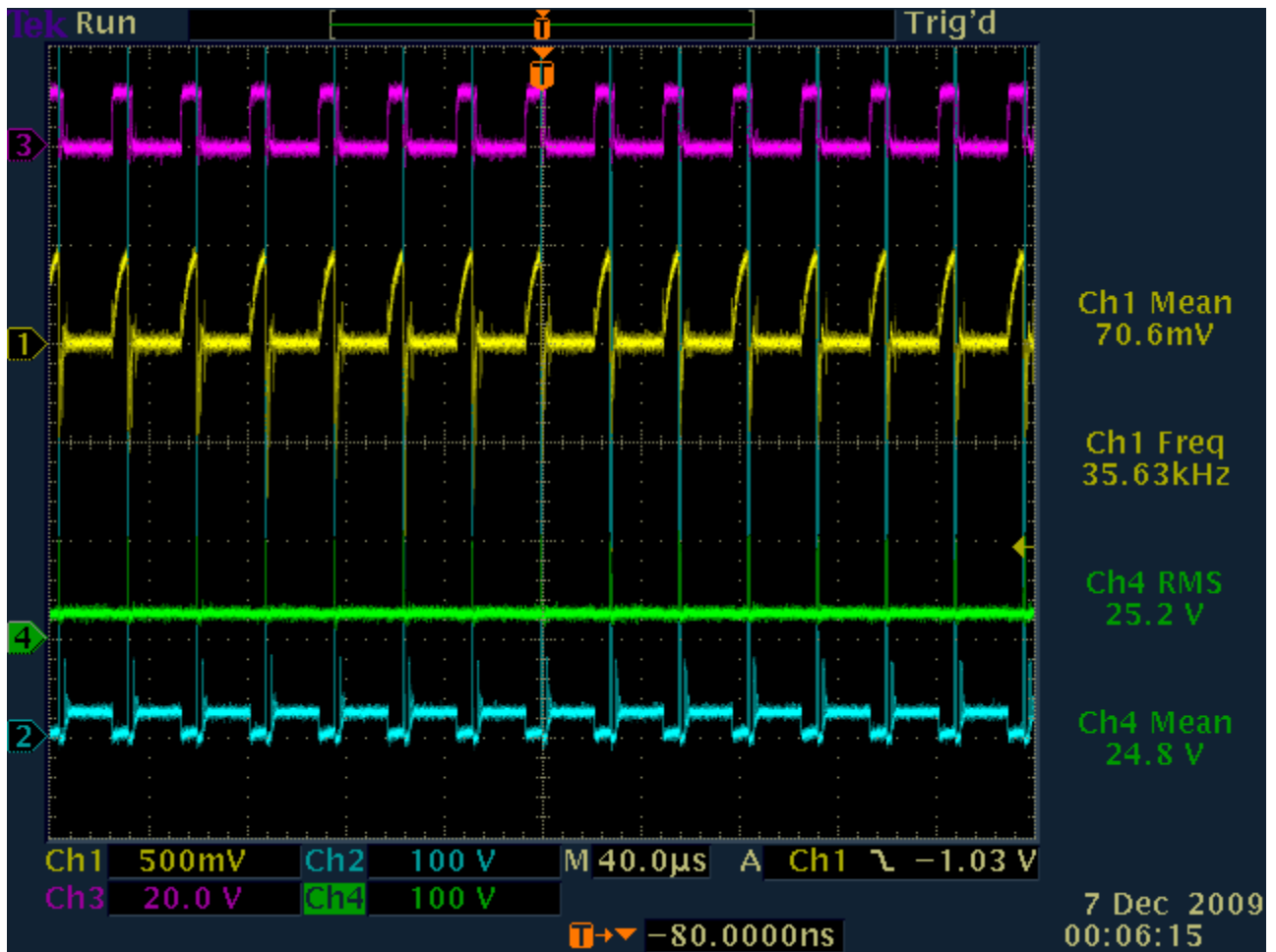

2\_20us

3\_40us

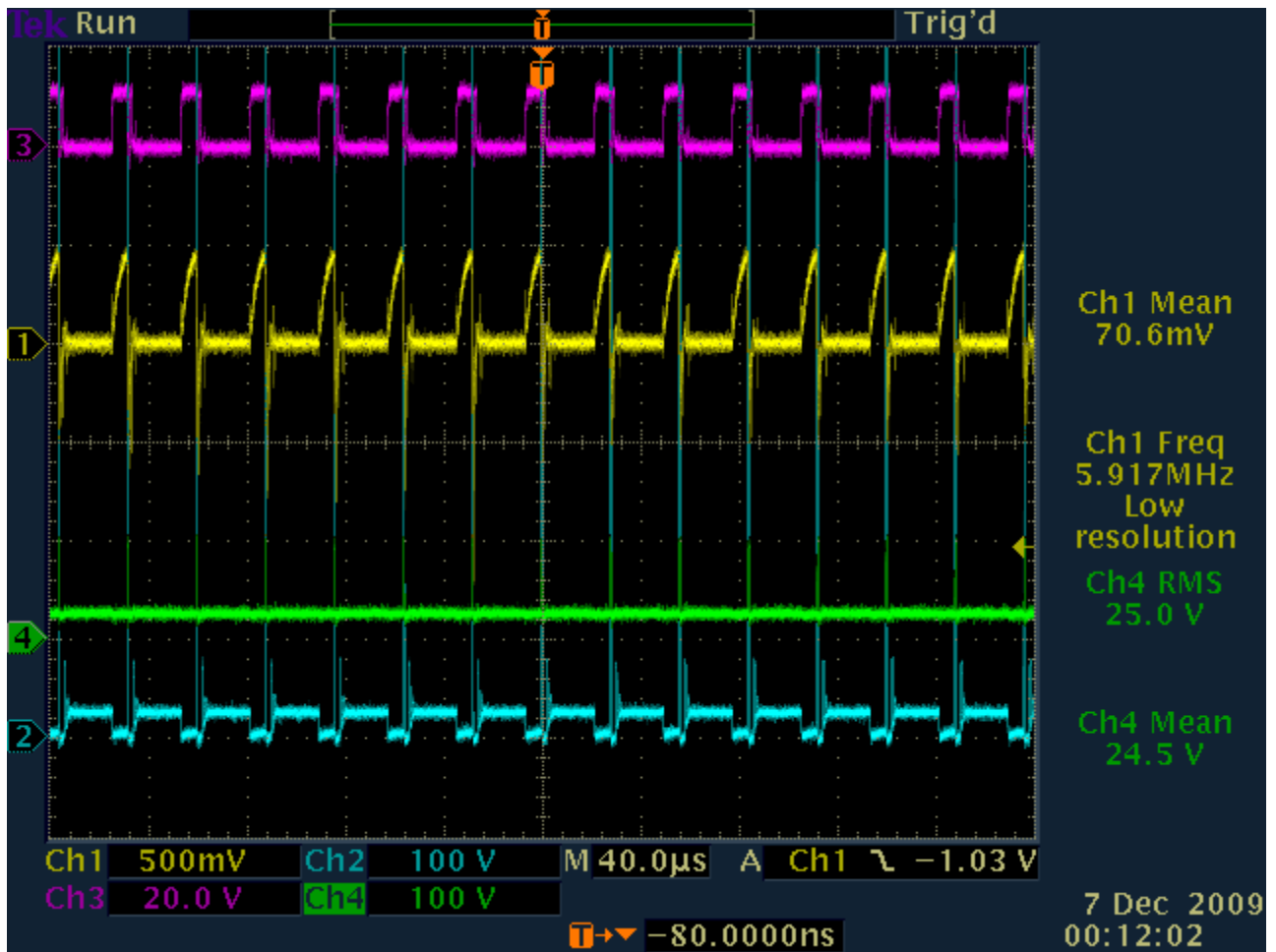

3\_20us

4\_40us

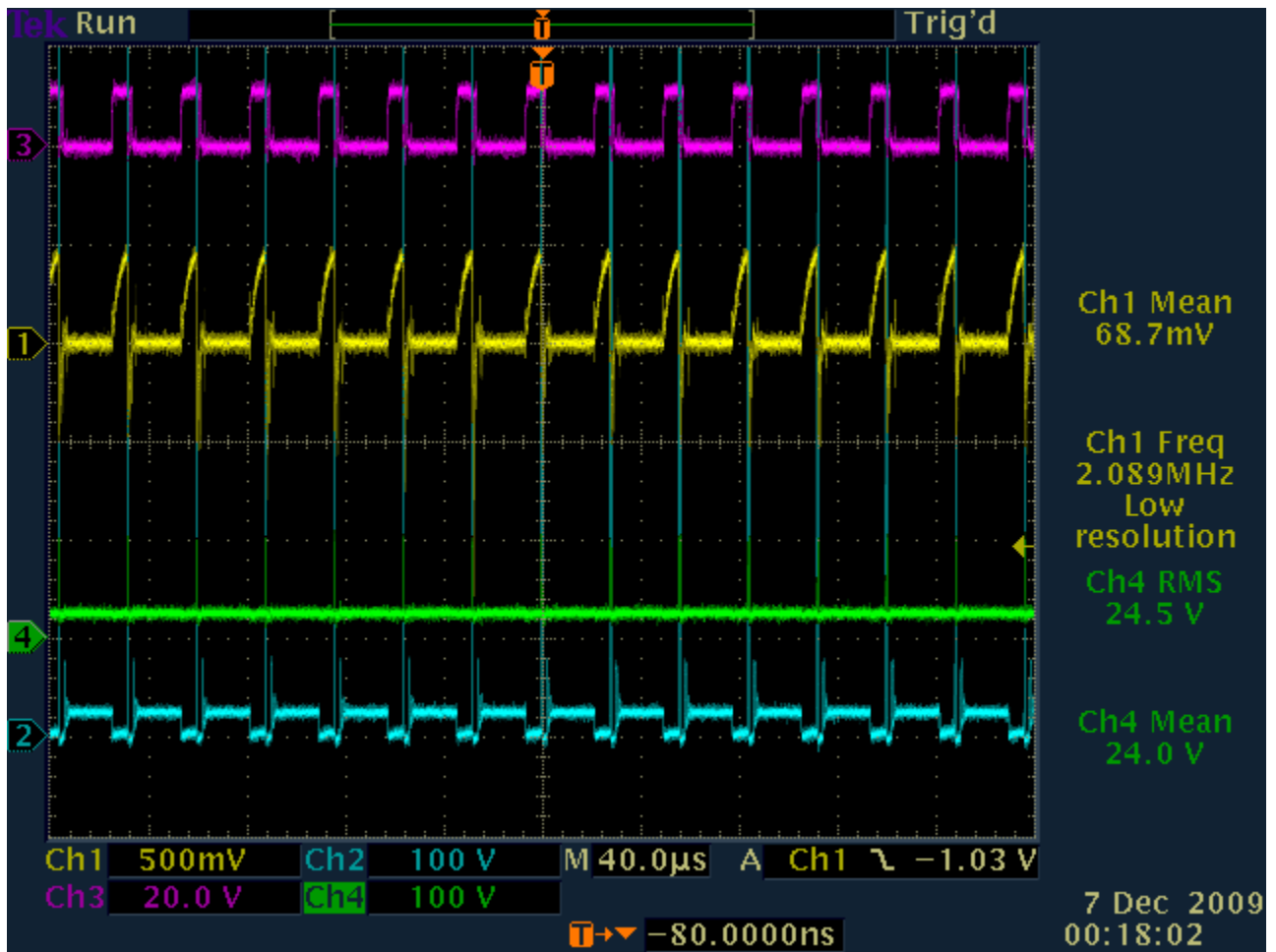

4\_20us

5\_40us

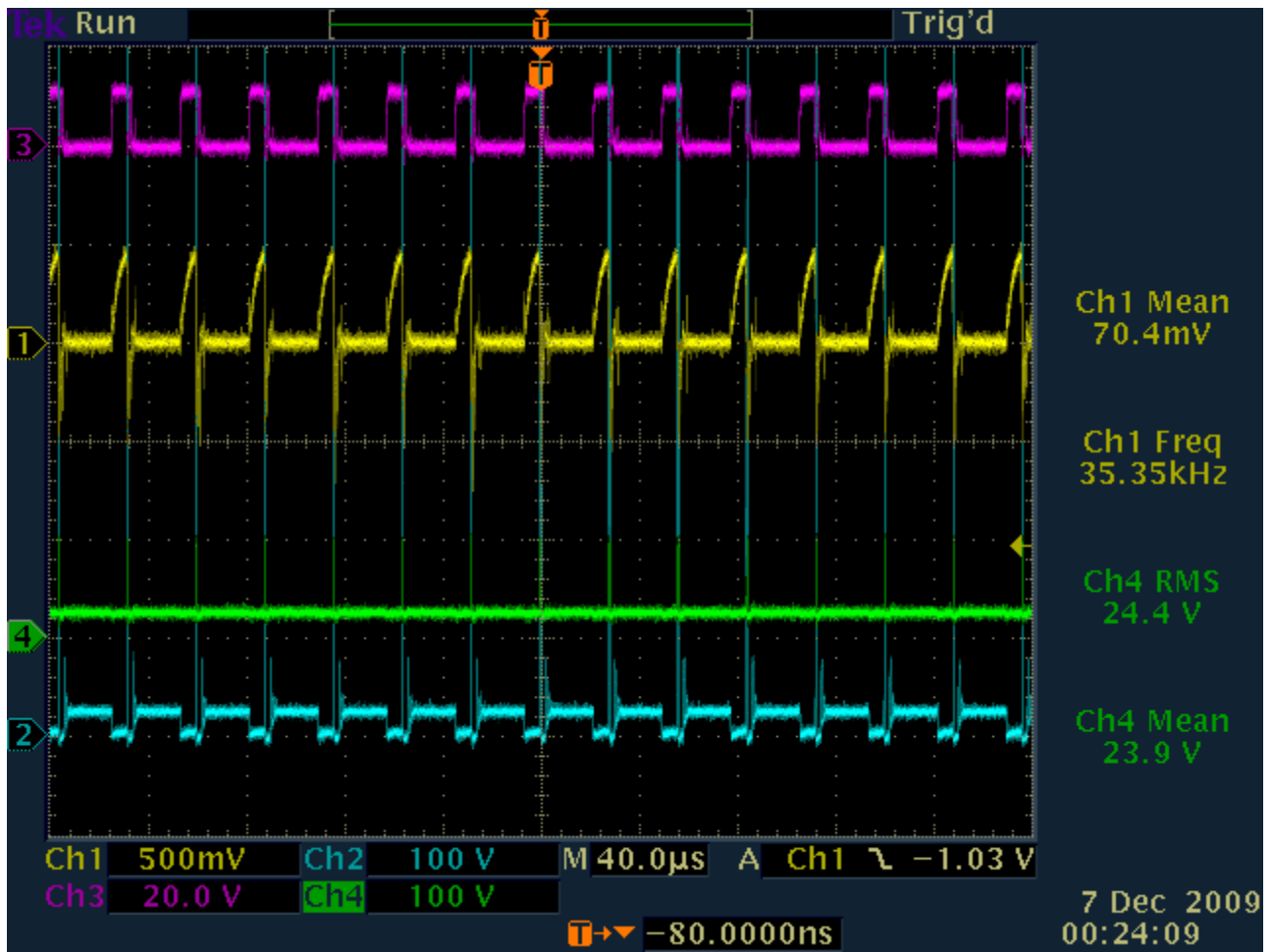

5\_20us

6\_40us



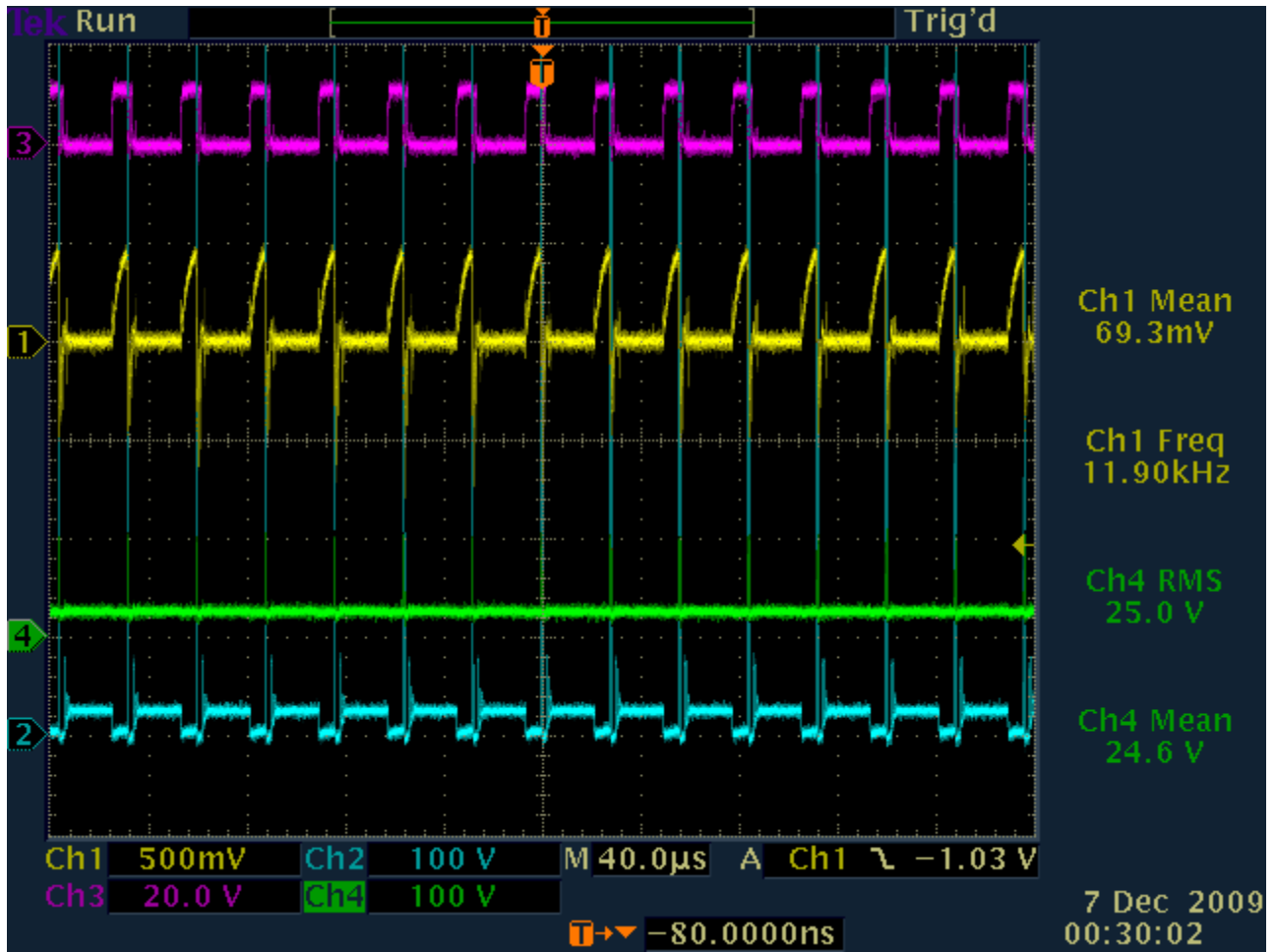

6\_20us

7\_40us

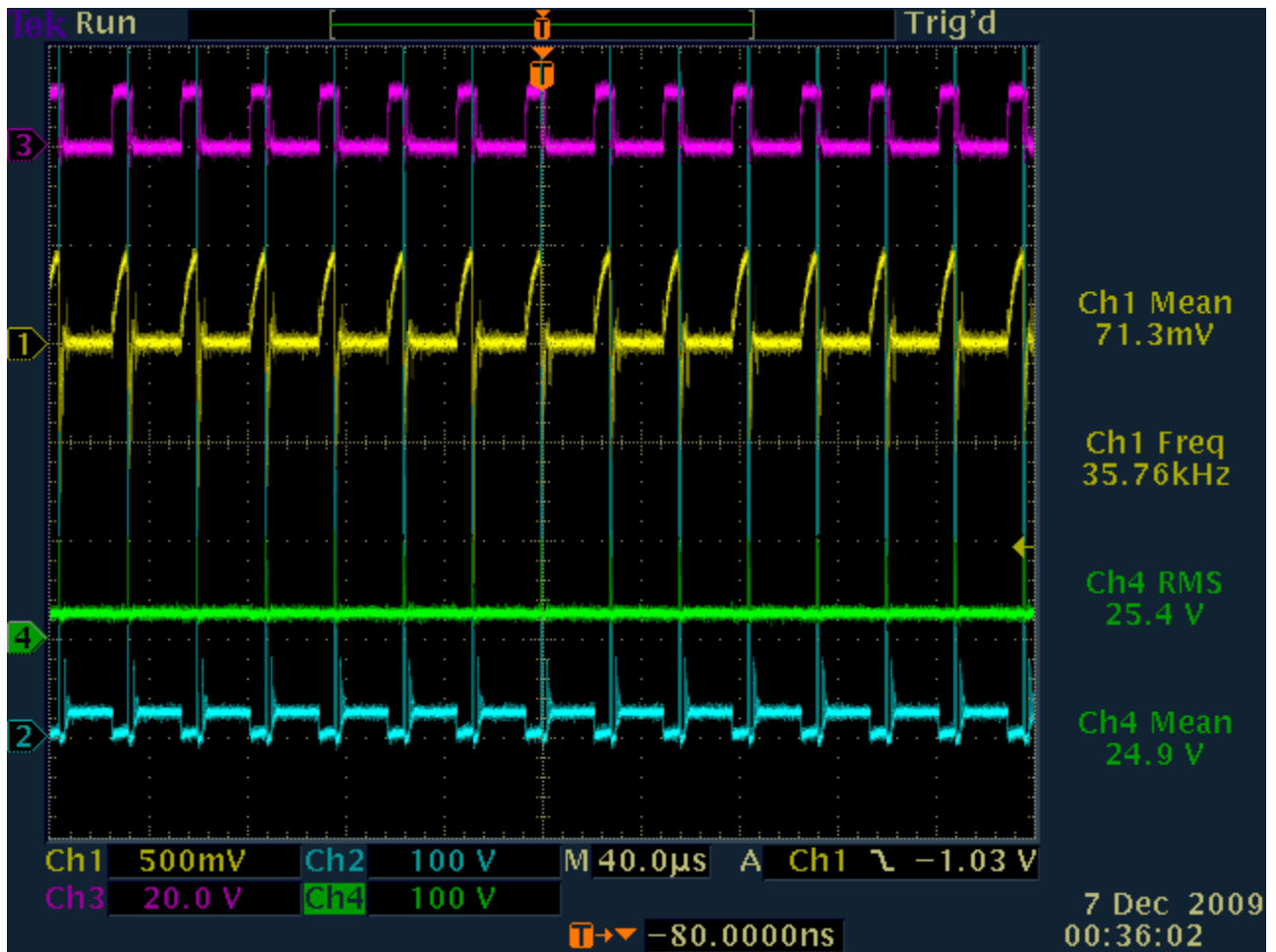

7\_20us

8\_40us

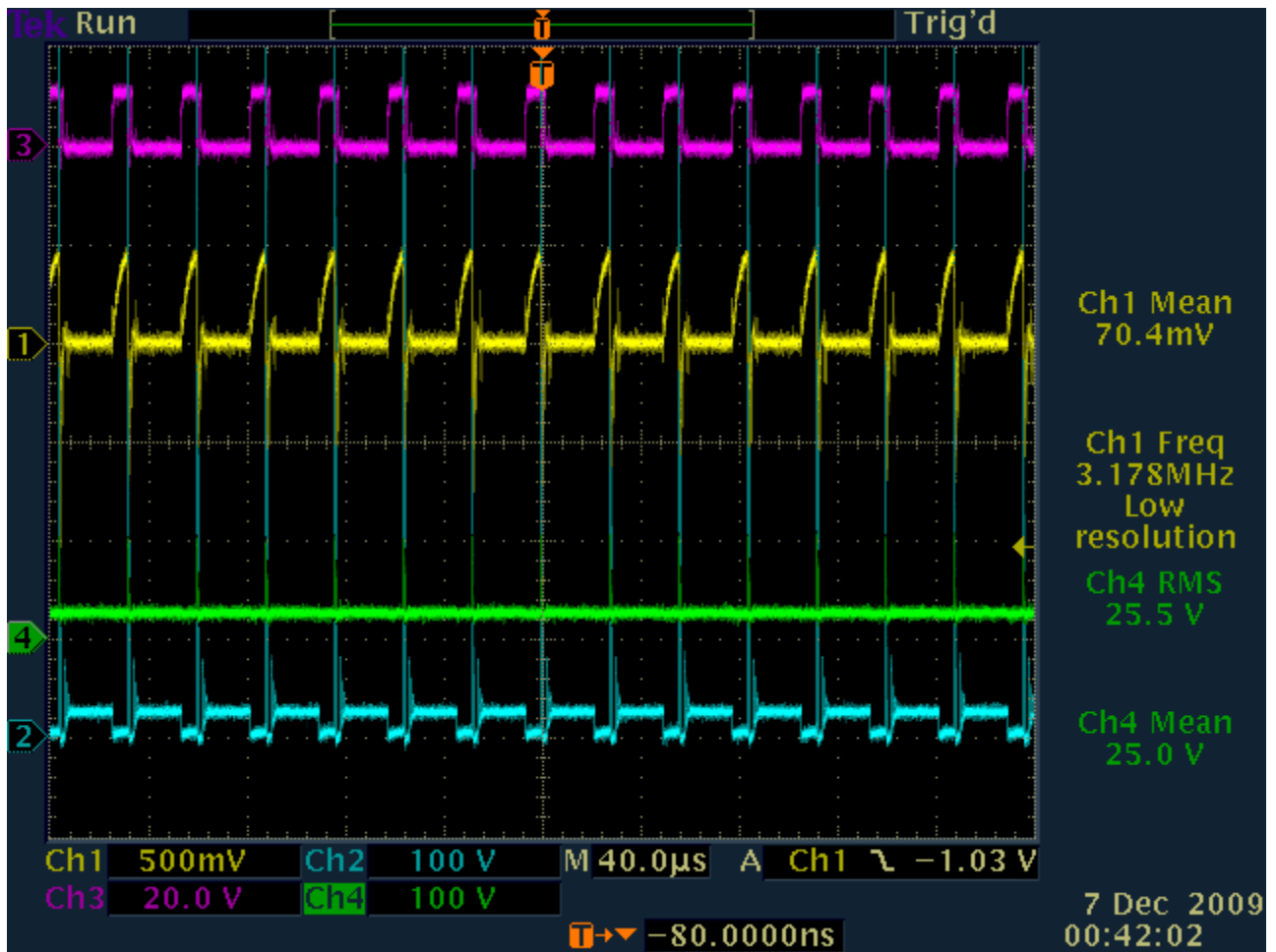

8\_20us

9\_40us

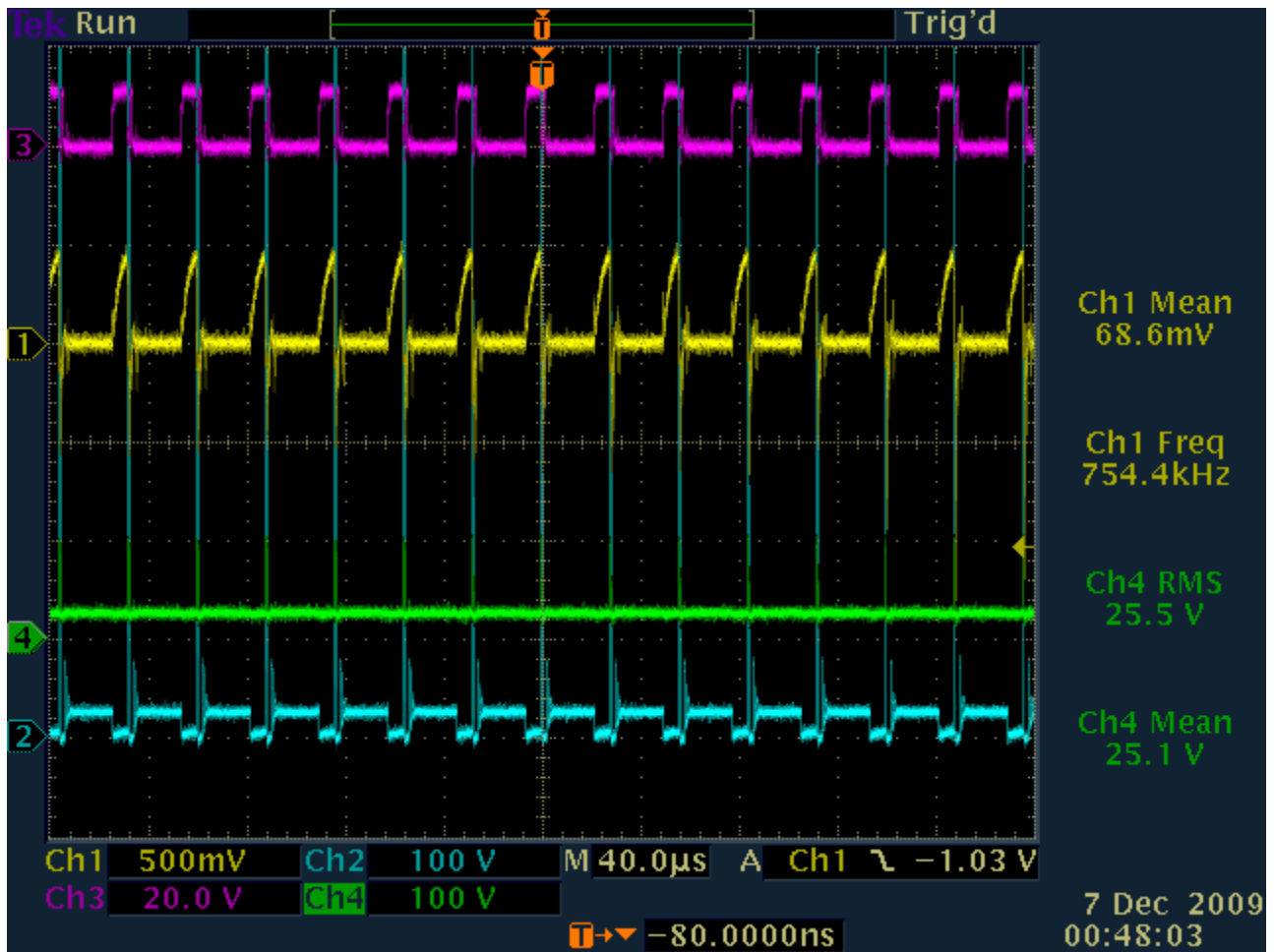

9\_20us

10\_40us

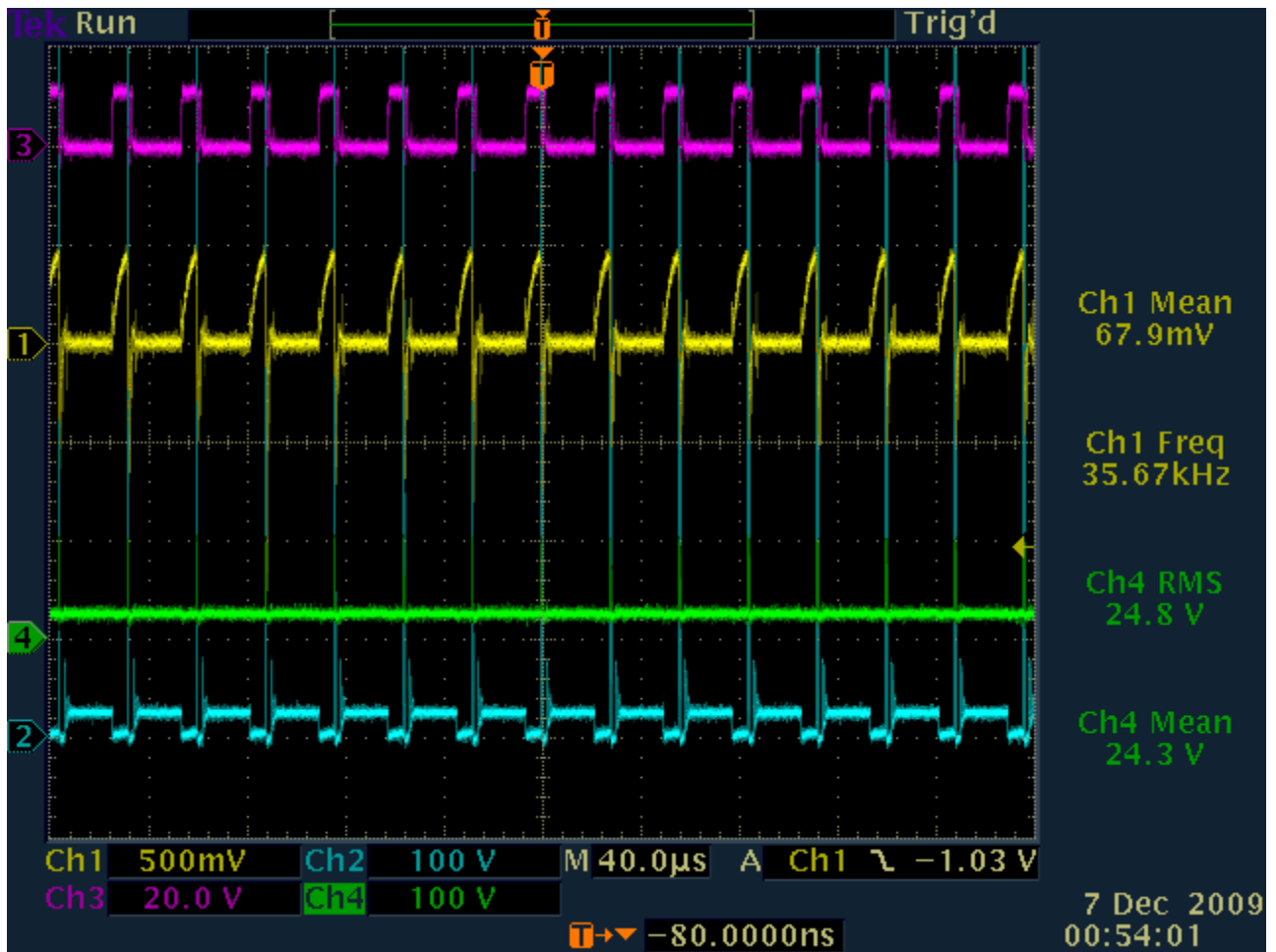

10\_20us

11\_40us

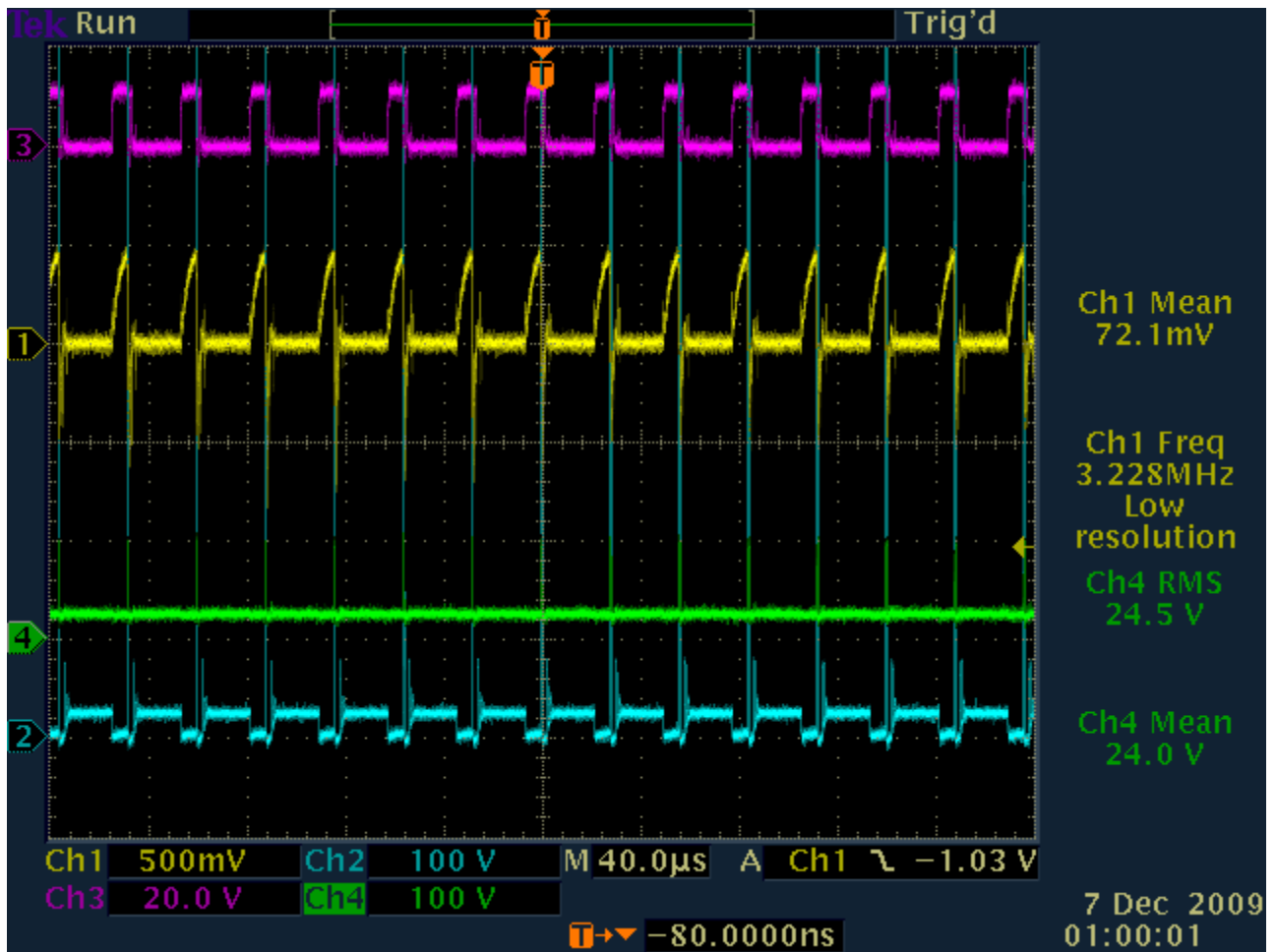

11\_20us

THERMAL - IMAGE - DATA KEY

TEST # 15  
 11-7-09  
 © WILSON JONES 02706 ColumnWhite #

" 76MM W/COIL "  
 1 HR X 6 MINUTE  
 11 IMAGE & DATA

Initials Date  
 Prepared By  
 Approved By

#	TIME	MS	TEK CSV	TEK PNG	AMBIENT °F	LOAD 10Ω °F	MOSFET °F	SHUNT °F
1	00:00	40	000	000	74.2	114	133	98
	DMM 24.64	20	001	001				
2	00:06	40	002	002	74.3	115	133	99
	DMM 24.64	20	003	003				
3	00:12	40	004	004	74.3	115	132	98
	DMM 24.63	20	005	005				
4	00:18	40	006	006	74.3	115	130	93
	DMM 24.63	20	007	007				
5	00:24	40	008	008	74.1	115	131	95
	DMM 24.63	20	009	009				
6	00:30	40	010	010	74.2	115	131	95
	DMM 24.62	20	011	011				
7	00:36	40	012	012	74.3	115	134	97
	DMM 24.62	20	013	013				
8	00:42	40	014	014	74.4	115	135	97
	DMM 24.62	20	015	015				
9	00:48	40	016	016	74.4	115	131	93
	DMM 24.61	20	017	017				
10	00:54	40	018	018	74.3	115	131	95
	DMM 24.61	20	019	019				
11	01:00	40	020	020	74.4	115	131	93
	DMM 24.61	20	021	021				
	CHANNEL -1			022				
	" -2			023				
	" -3			024				
	" -4			025				
	2us			026		400NS	028	
	100NS			027		4us	029	

100ns

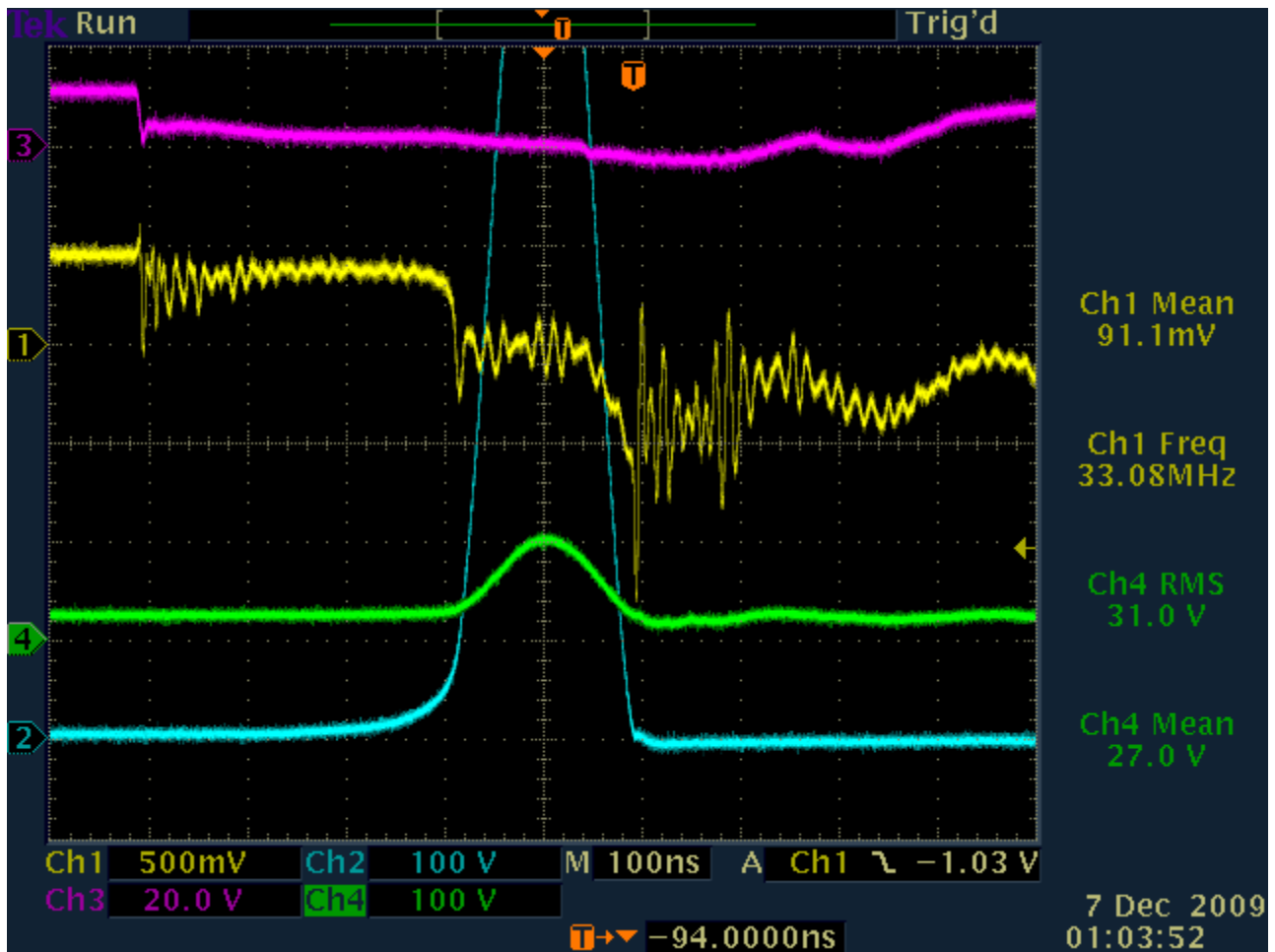

All Images and data by a Tektronix TDS 3054C from the Tektronix Corporation

[Glen's Rosemary Ainslie COP>17 Heater Circuit – DATA TEST #15](#)

Closing comments from Fuzzy -The results from Test #15 and Test #14 also needs to have a "Temperature Profile" done on the prototype 76mm x 10 Ohm load resistor when I can acquire another 30 Volt variable power supply to get some figures we can go by. The circuit Harmonics were there as strong as ever but when running at a lower frequency the TDS 3054C sampling needs to be at around 200us to see it clearly.

### Test #16

This a re-test of the experimental prototype borosilicate (32mm OD) tube 10 Ohm load resistor that the coil is 32mm inside Diameter x ten (10) inches long with 48 turns of #20 AWG Ni-Cr Type "A" wire with a calculated 8.64 uH of inductance. This is another one (1) hour test with 40us and 20us readings taken every six (6) minutes for a total of eleven



(11) readings or twenty two (22) Image and Data files for one (1) hour.

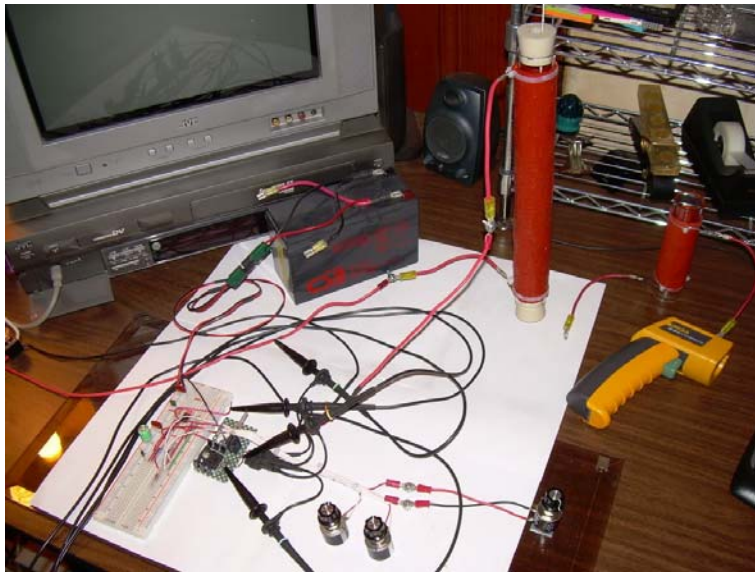

[Rosemary Ainslie COP>17 Heater Circuit](#)  
["Quantum" October 2002](#)

#### **Replication Components -**

- 1) [International Rectifier - IRFPG50 HEXFET® Power MOSFET](#)  
w/ Sil-Pad insulator between Mosfet and Heat Sink
- 2) [Fairchild Semiconductor - NE555N Timer](#)
- 3) [Vishay Spectrol - SP534 Percision Potentiometer/ 10-turn 2-Watt](#)
- 4) [Exide Technologies Battery "Liquid Lead Acid" Model # GT-H - TRACTOR 12V 12Ah CCA 235](#)
- 5) CSB Battery Company "Gel Lead Acid" #GP 1270 F2 / 12 Volt 7.0 Ah
- 6) Prototype 76mm Load Resister 10 ohm + - 5%
- 7) "Shunt" - Caddock High Performance Film Resistor "non-inductive" 30 watt type  
[MP930-0.25-1%](#)

## Temperature Measurements -

Fluke 62 "mini" IR Thermometer ( used maximum reading on each component )

## Digital Multi Meter -

Fluke 87 DMM true RMS

Channel 1 - Mosfet source shunt

Channel 2 - Mosfet drain

Channel 3 - 555 Timer pin #3

Channel 4 - 24 VDC "Liquid" Lead Acid Battery Bank

1\_40us

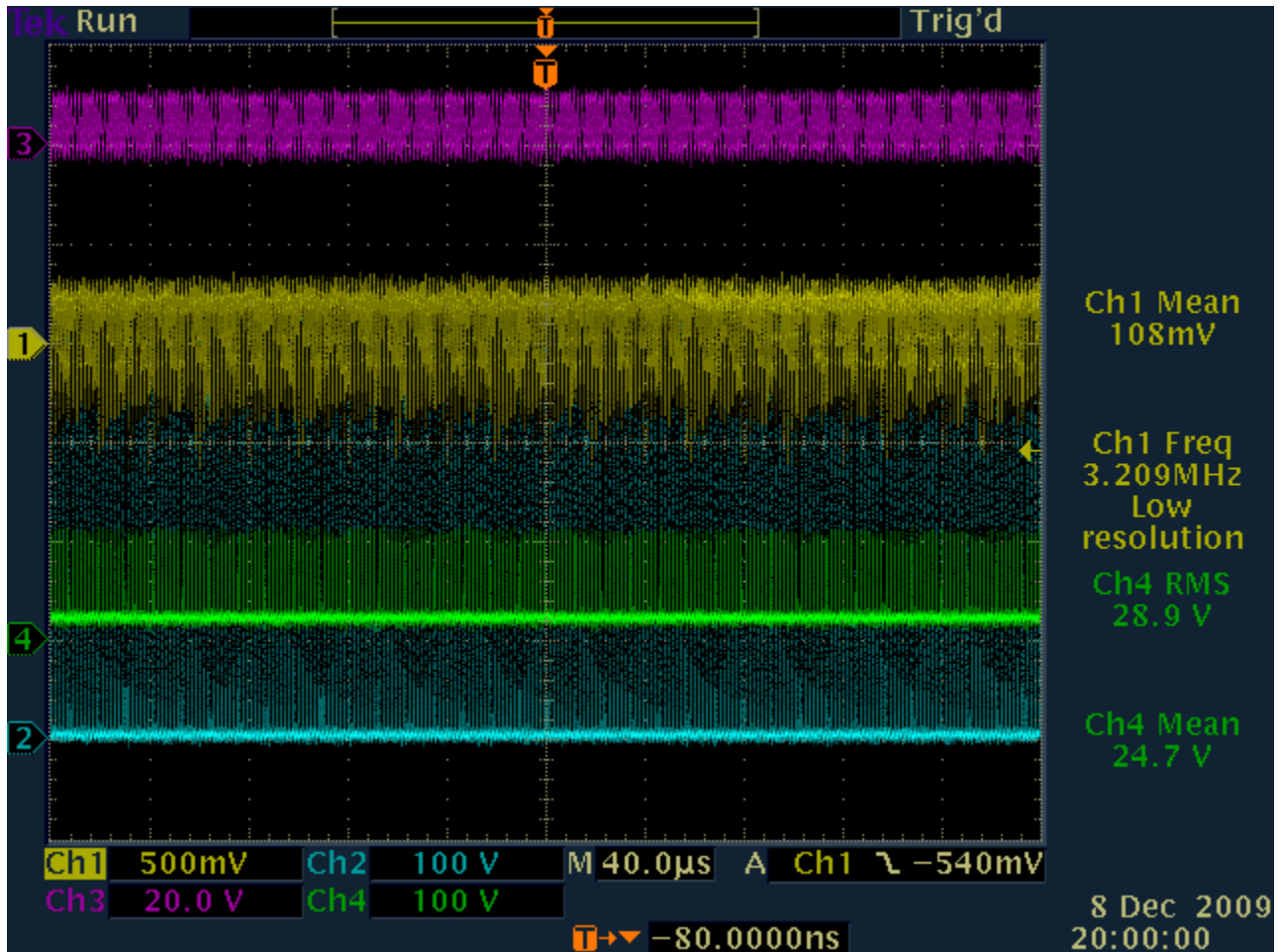

1\_20us

2\_40us

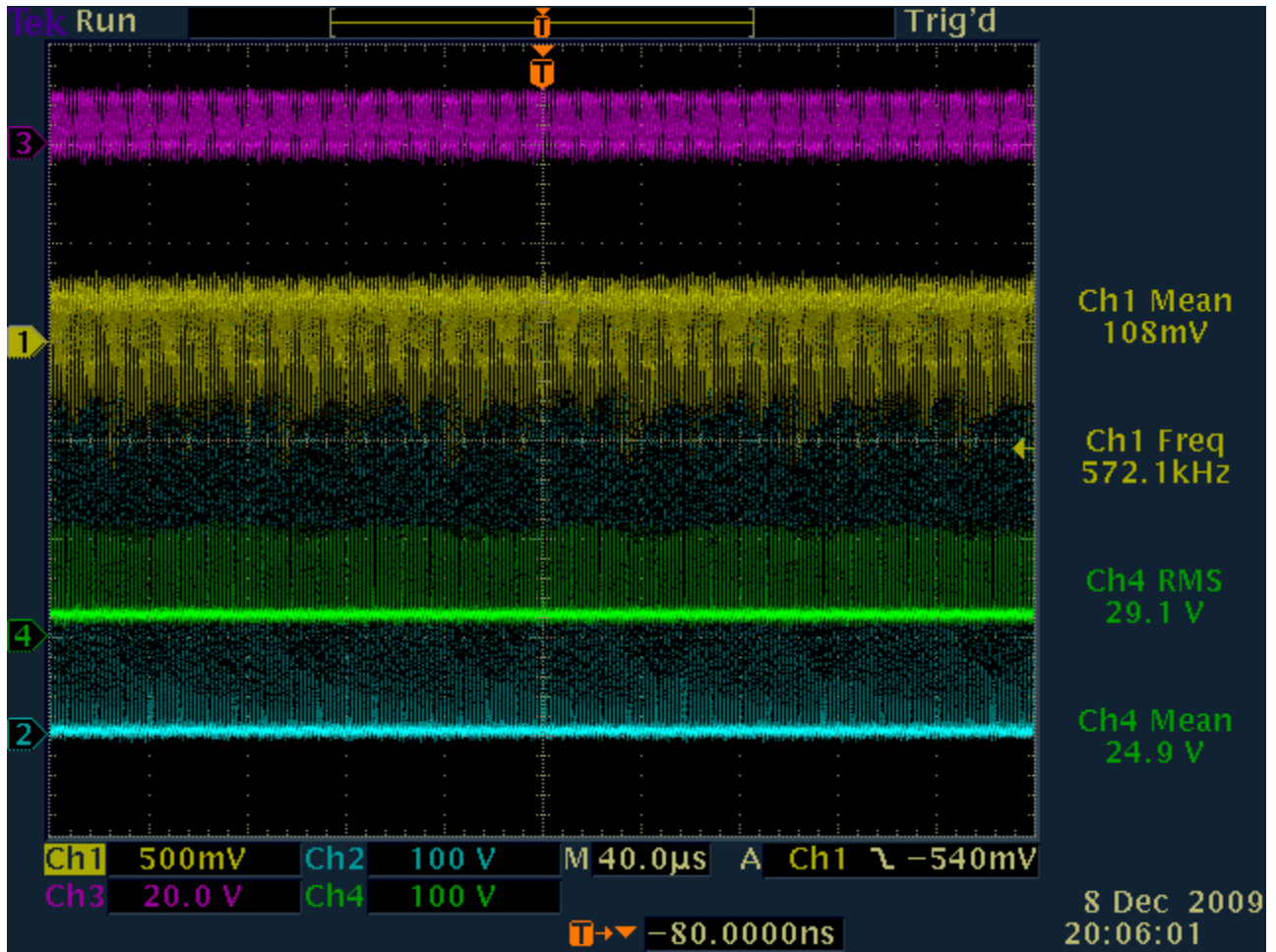

2\_20us

3\_40us

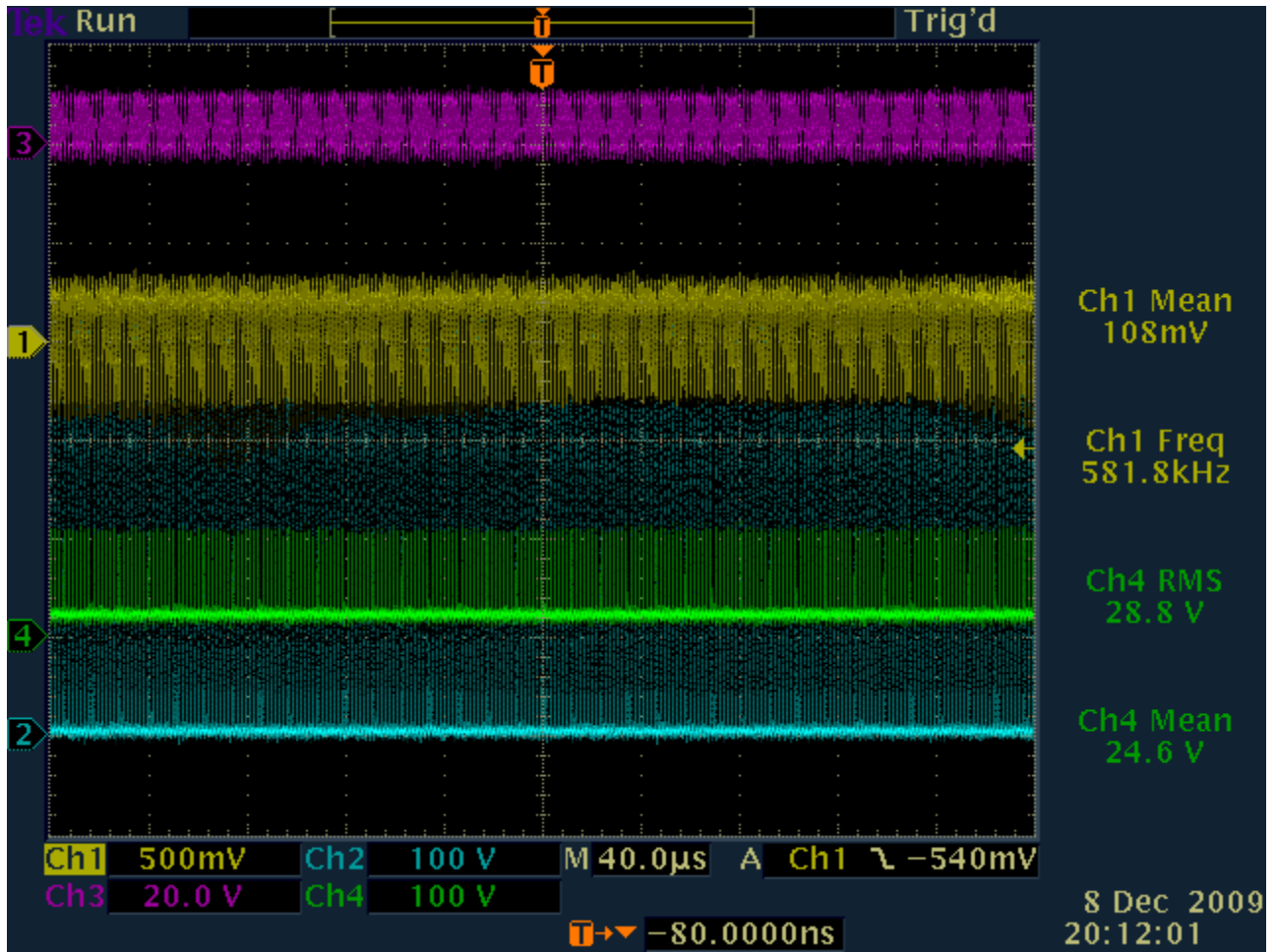

3\_20us

4\_40us

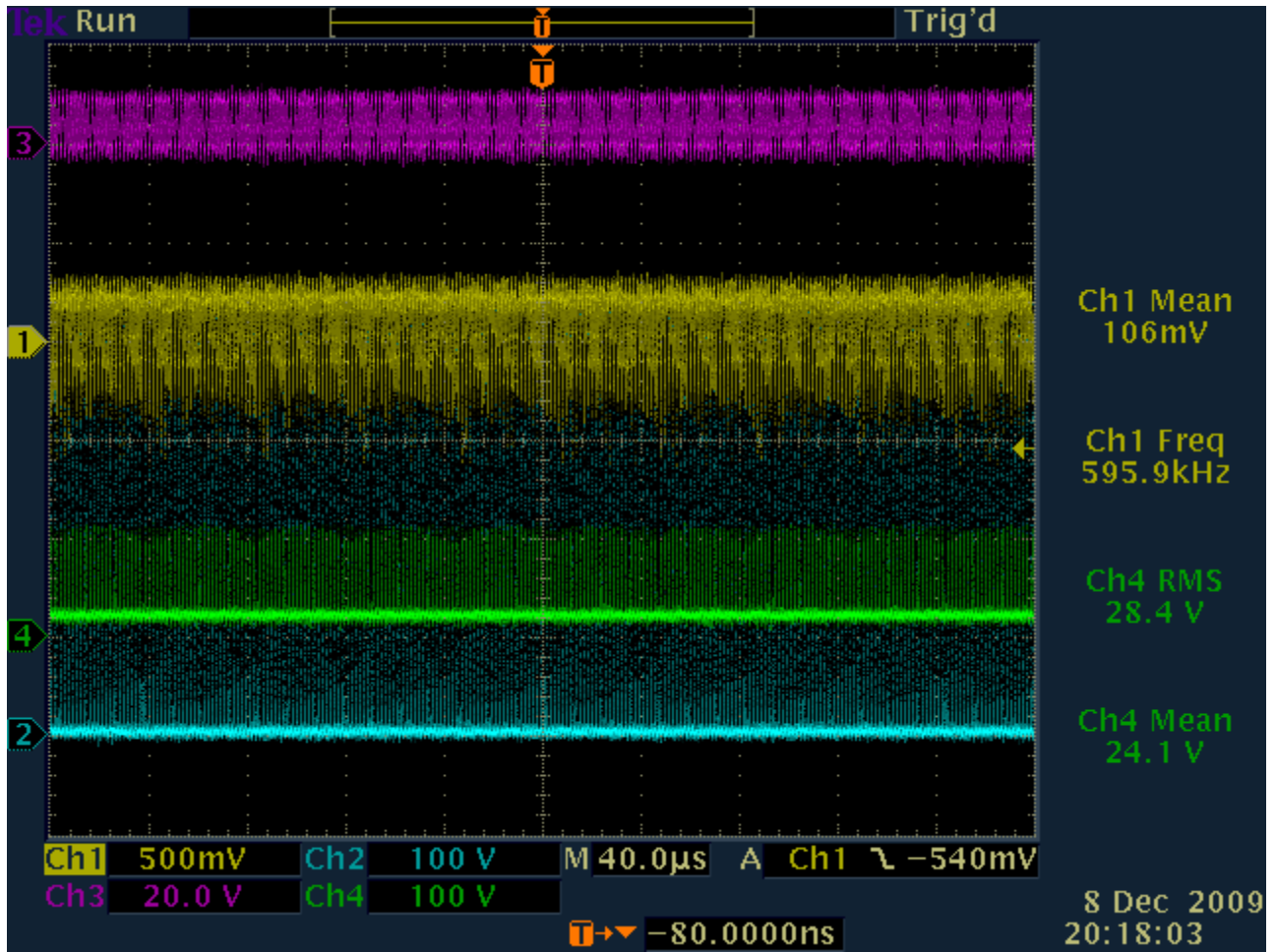

4\_20us

5\_40us

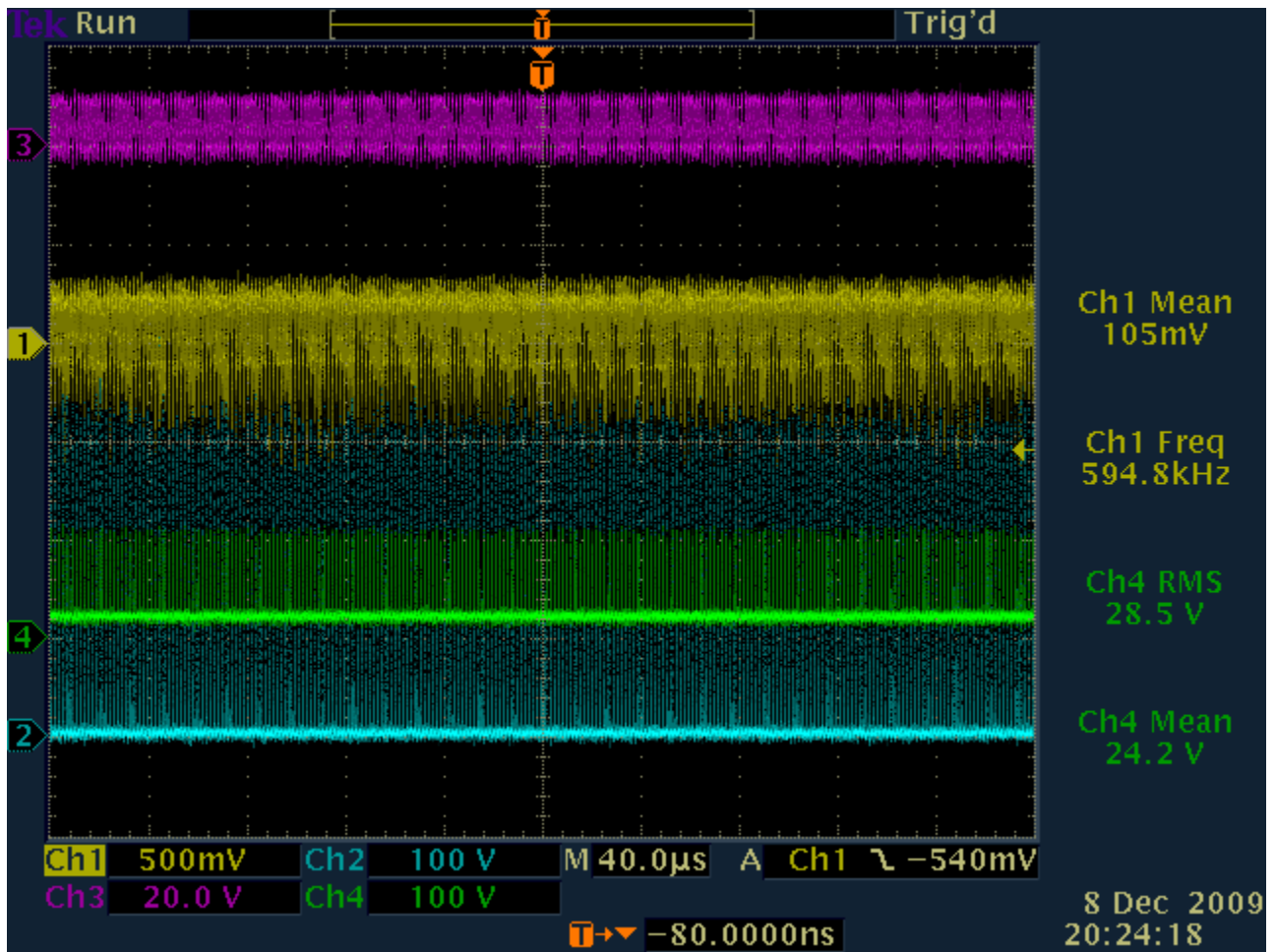

5\_20us

6\_40us

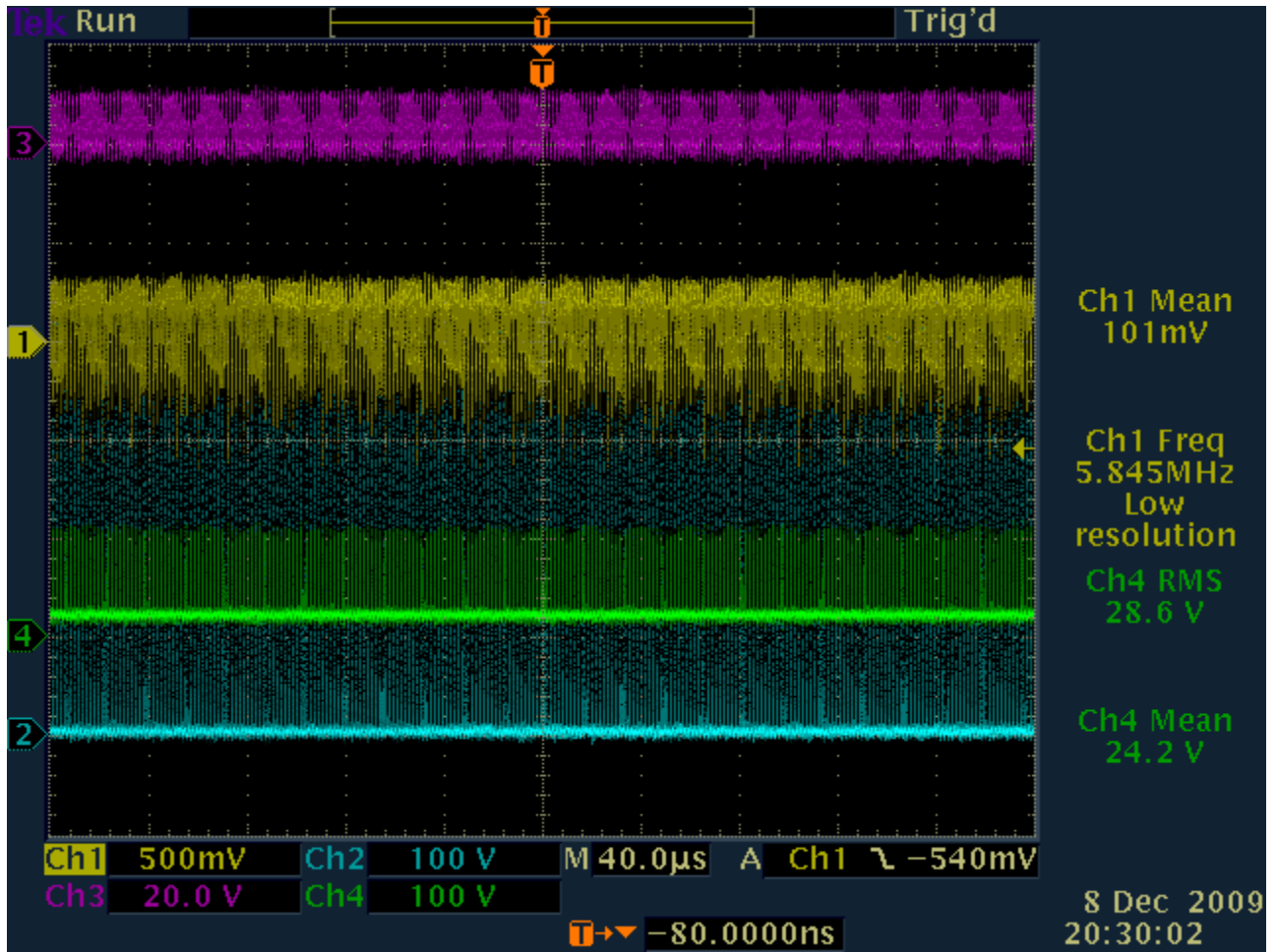

6\_20us

7\_40us

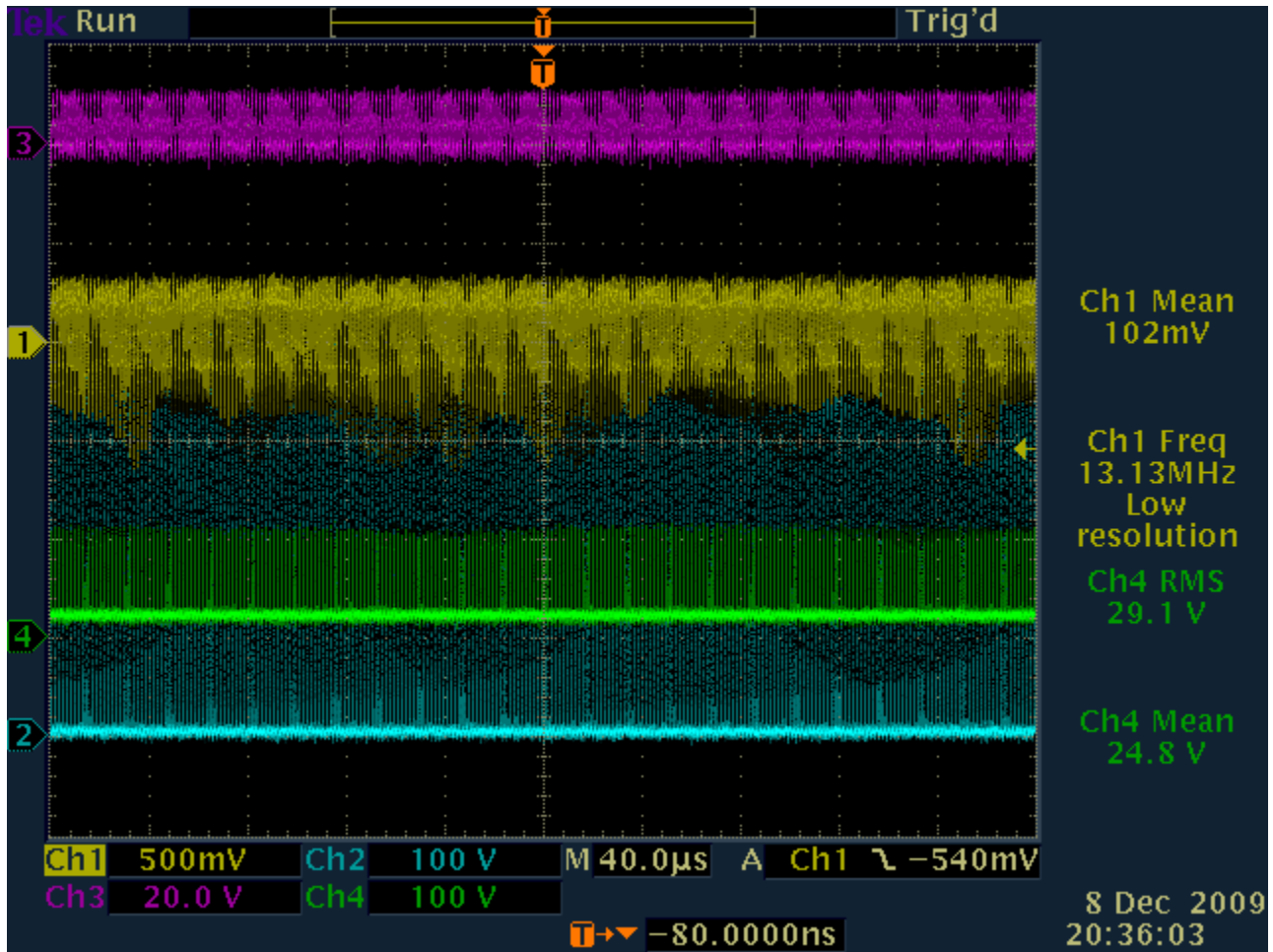

7\_20us

8\_40us



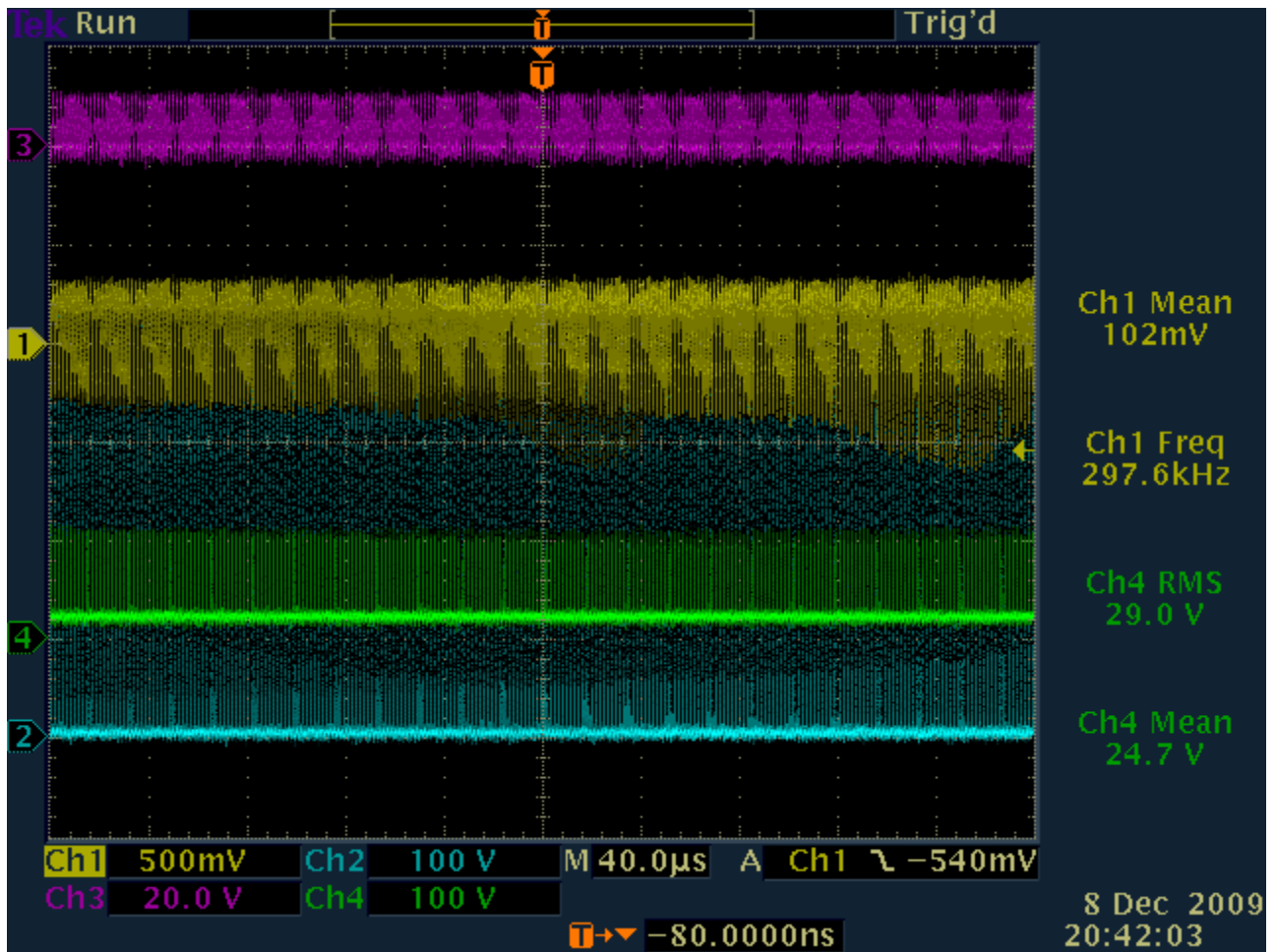

8\_20us

9\_40us

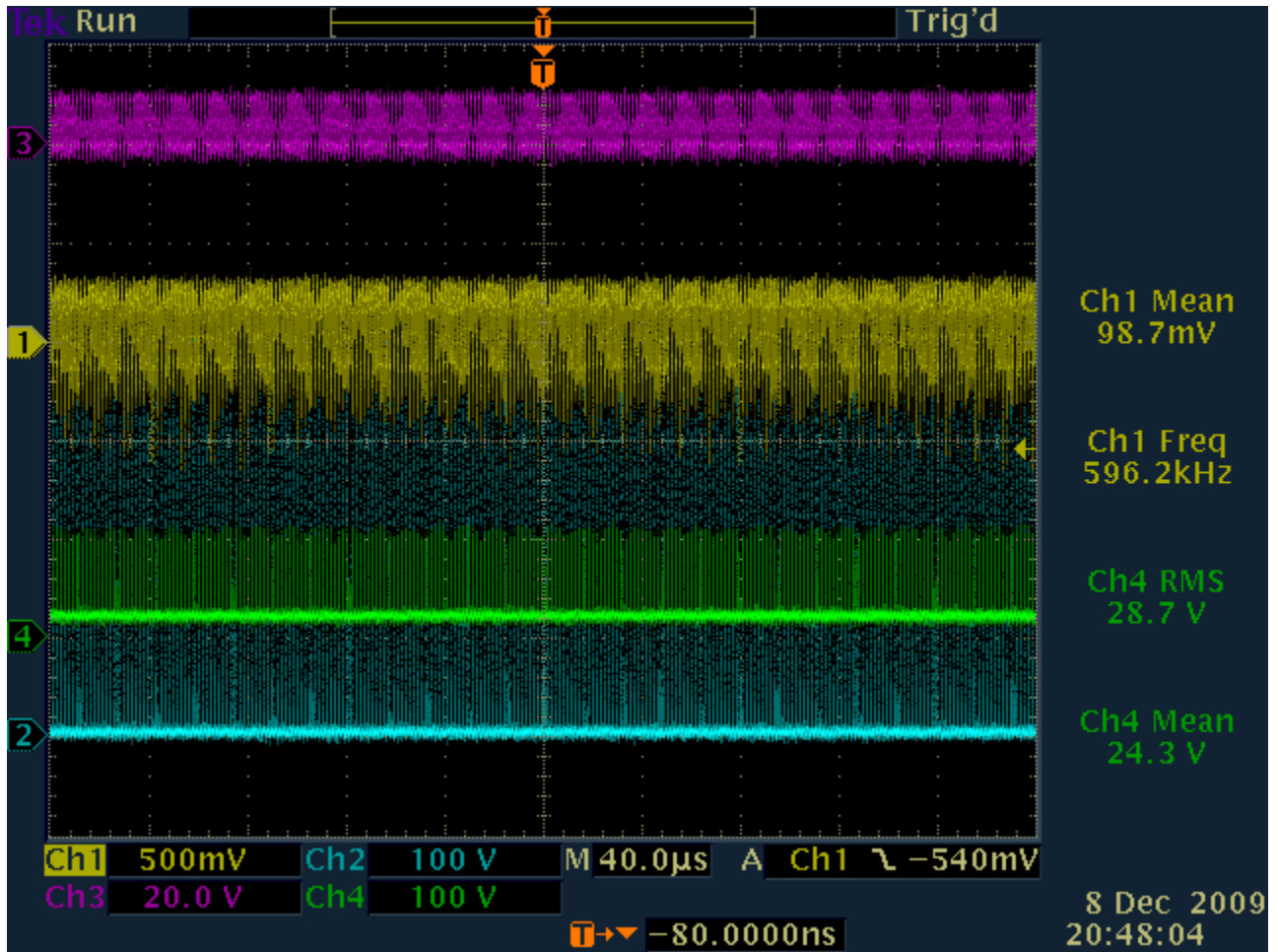

9\_20us

10\_40us

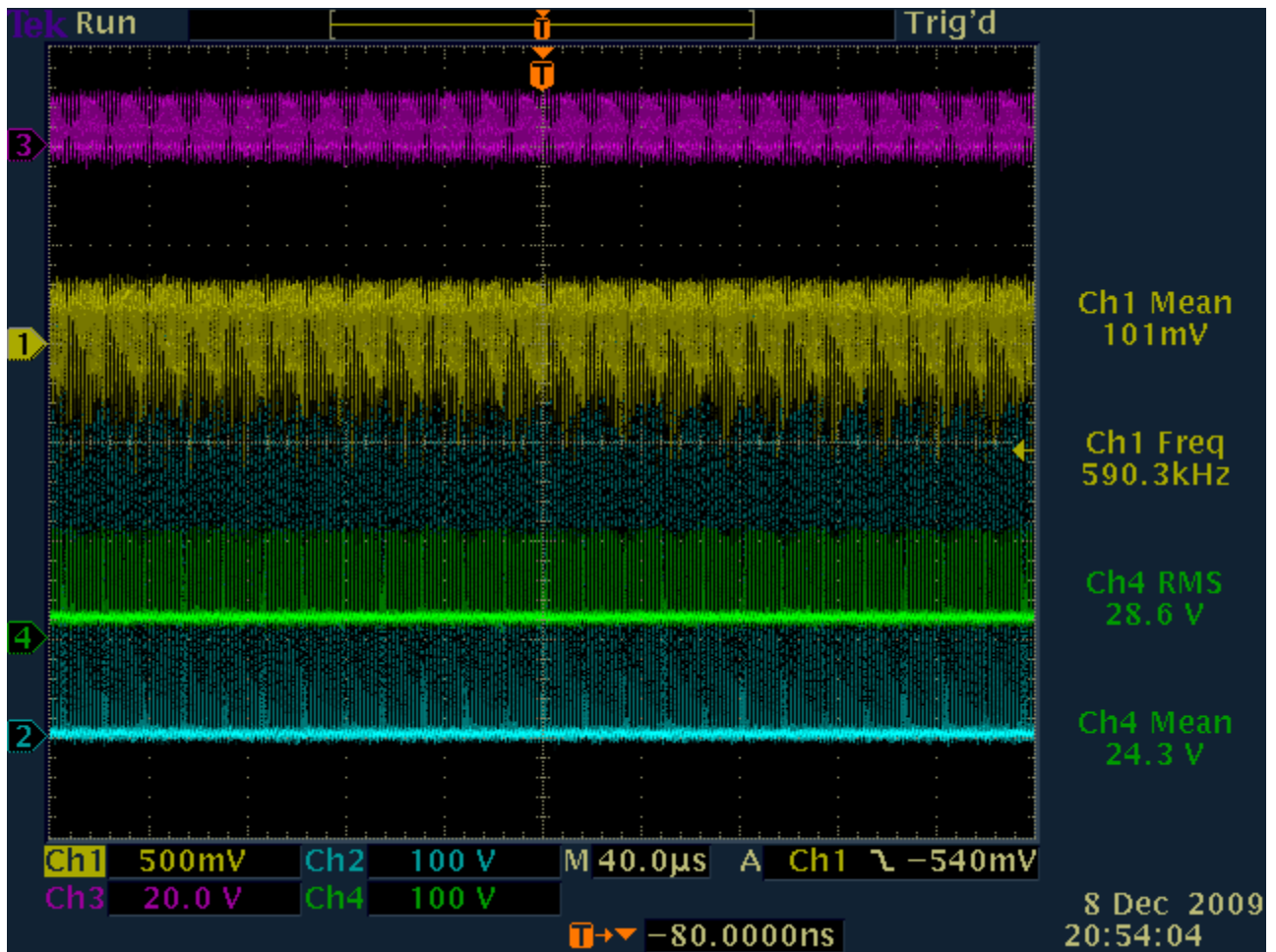

10\_20us

11\_40us

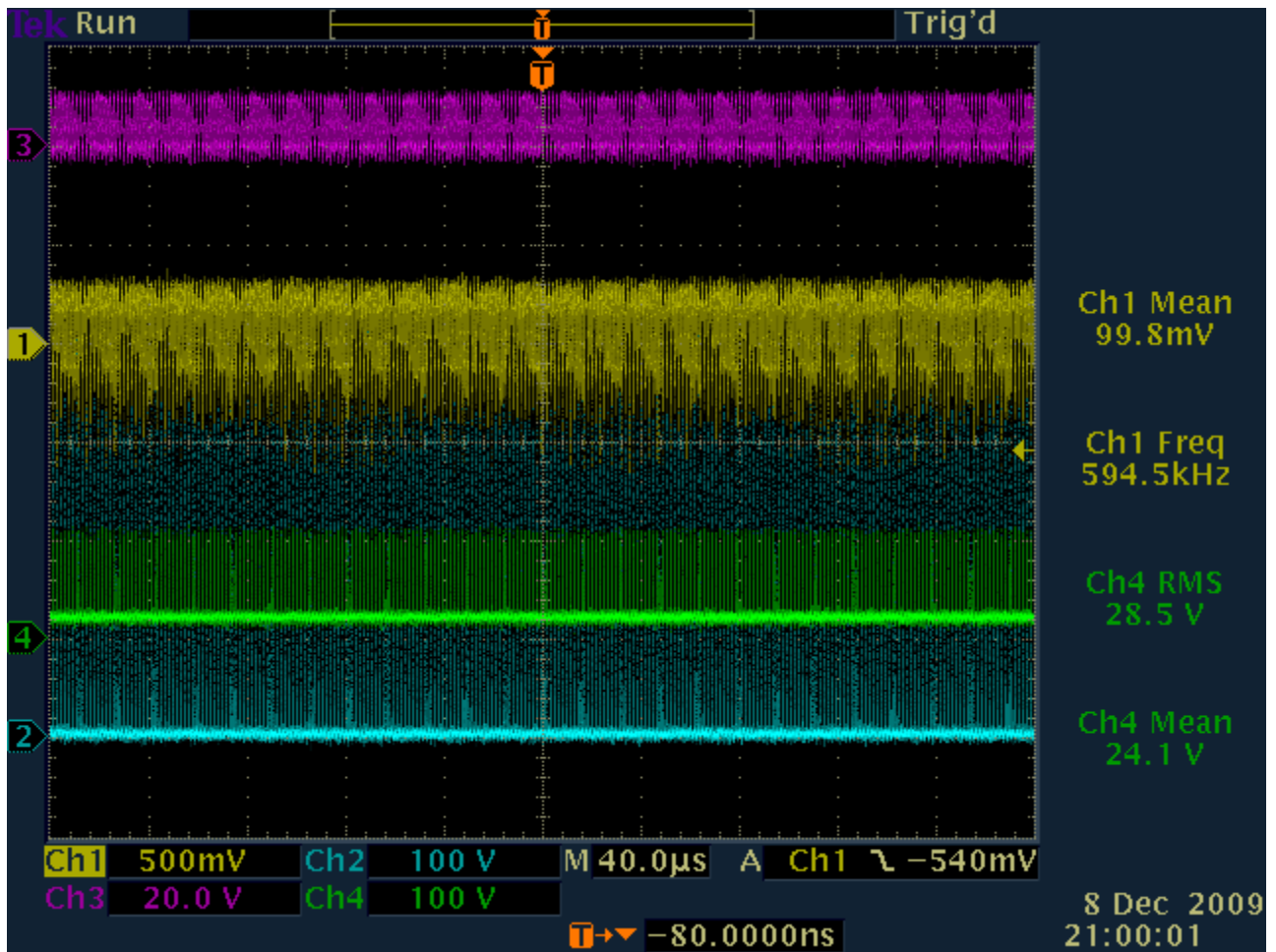

11\_20us

IMAGE - DATA - THERMAL KEY

TEST # 16  
11-08-09

11" 8.64UH  
1HR X 6MINUTE  
11 IMAGE & DATA

Prepared By: \_\_\_\_\_ Initials: \_\_\_\_\_ Date: \_\_\_\_\_  
Approved By: \_\_\_\_\_

© WILSON JONES G7508 ColumnWrite®

#	TIME	TEK CSV	TEK PNG	AMBIENT °F	LOAD °C/F	MOSFET °F	SHUNT °F
1	20:00	40 000	000	74.2	118	178	111
	DMM 24.55	20 001	001				
2	20:06	40 002	002	74.3	117	178	115
	DMM 24.55	20 003	003				
3	20:12	40 004	004	74.4	117	178	106
	DMM 24.54	20 005	005				
4	20:18	40 006	006	74.3	116	175	106
	DMM 24.54	20 007	007				
5	20:24	40 008	008	74.2	116	176	110
	DMM 24.53	20 009	009				
6	20:30	40 010	010	74.1	116	172	109
	DMM 24.53	20 011	011				
7	20:36	40 012	012	74.4	115	170	107
	DMM 24.53	20 013	013				
8	20:42	40 014	014	74.6	115	170	106
	DMM 24.52	20 015	015				
9	20:48	40 016	016	74.4	115	167	103
	DMM 24.52	20 017	017				
10	20:54	40 018	018	74.3	115	169	106
	DMM 24.51	20 019	019				
11	21:00	40 020	020	74.2	115	169	110
	DMM 24.51	20 021	021				
	CHANNEL -1		022				
	-2		023				
	-3		024				
	-4		025				
	400NS		026		100NS	028	
	200NS		027		4MS	029	

CHANNEL IMAGE SNAP SHOT DATA

100\_ns

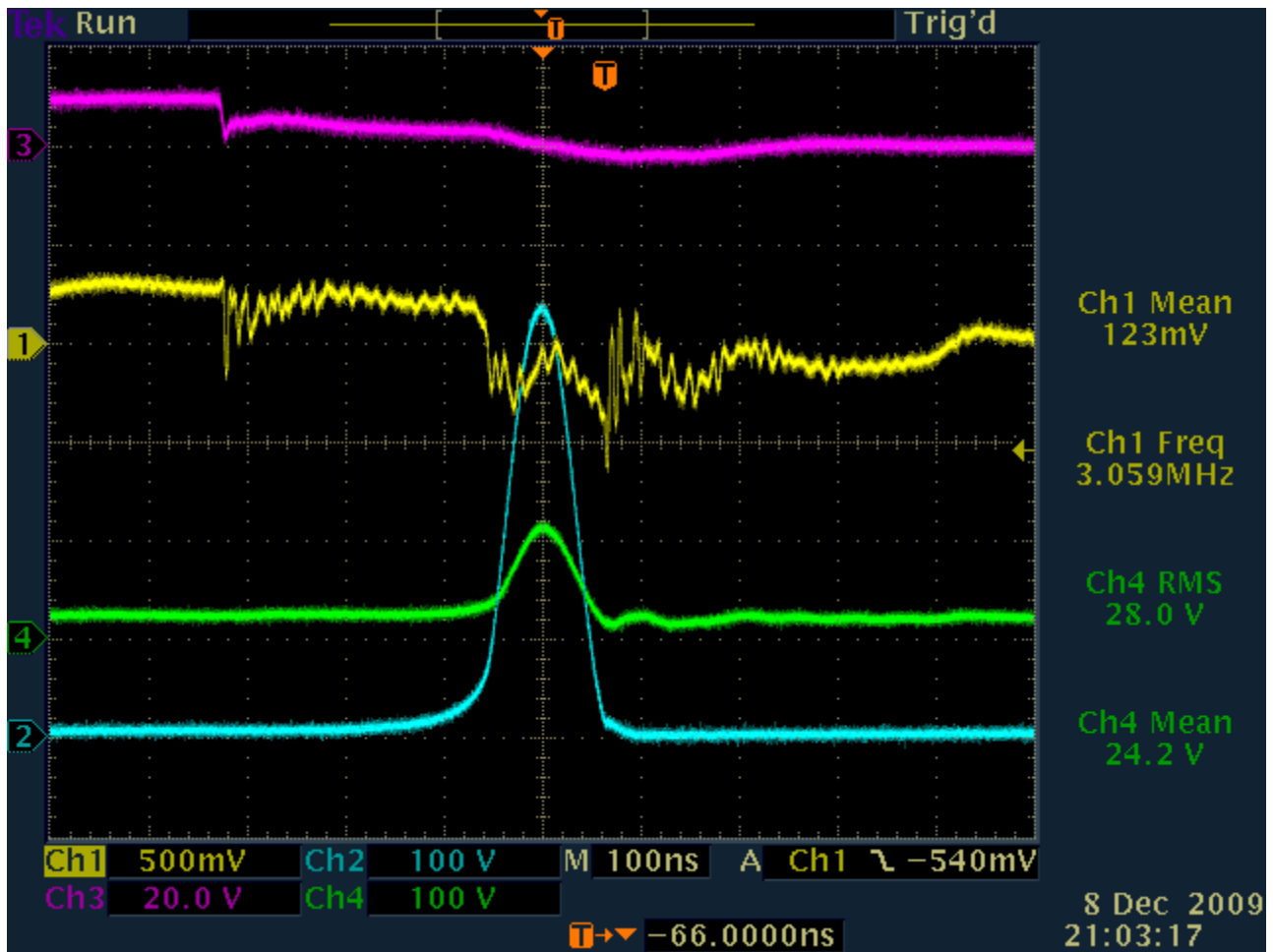

### TEST #16 - Battery Draw Down

Every time I do a test I leave the circuit running and draw down the battery's some prior to doing a re-charge for the next tests .... here is some data on Test #16 a battery draw down starting off at 3 hours "AFTER" the test was completed and went on to 13 hours "AFTER" the test was done .....

**+3 Hours**

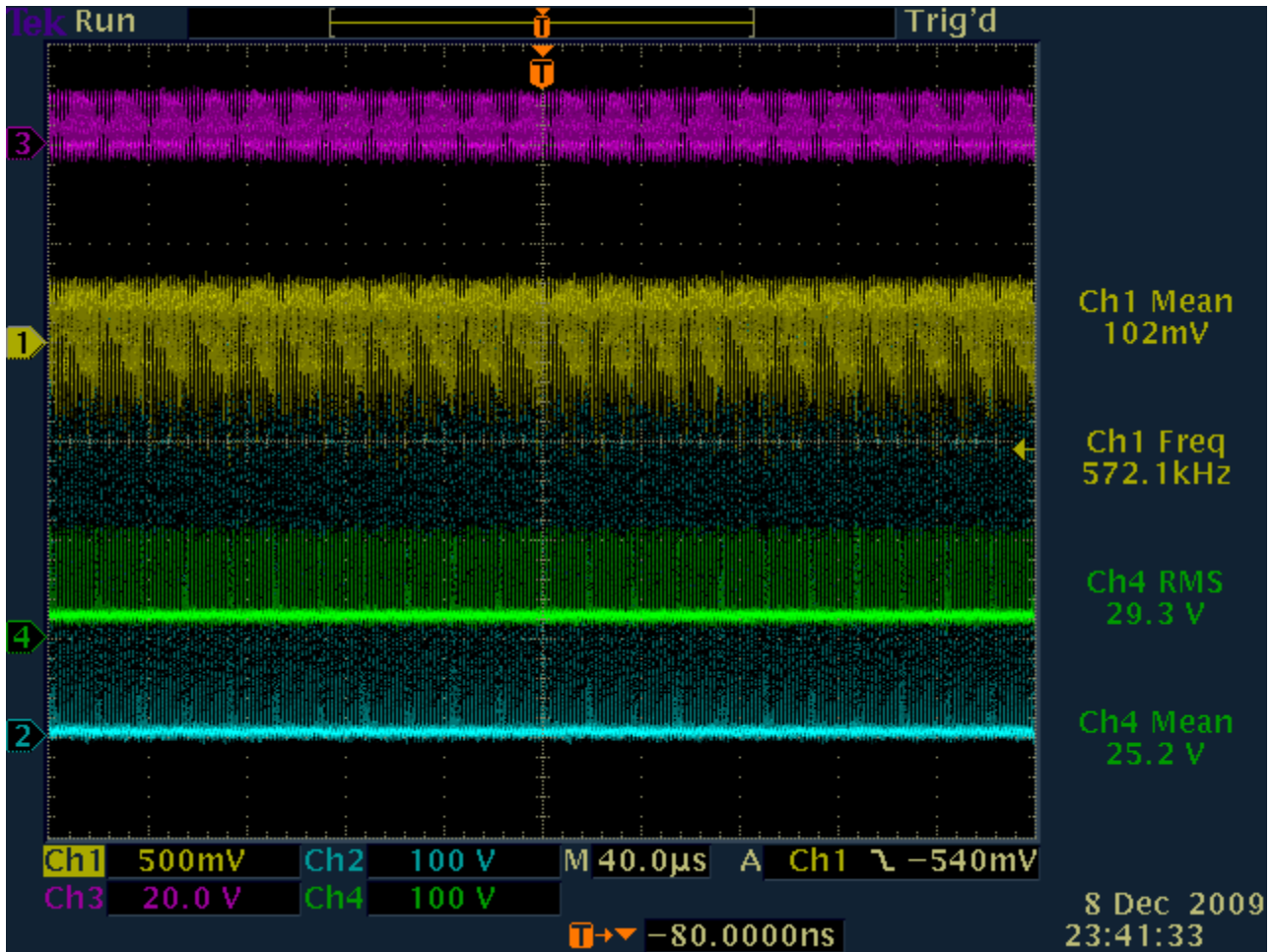

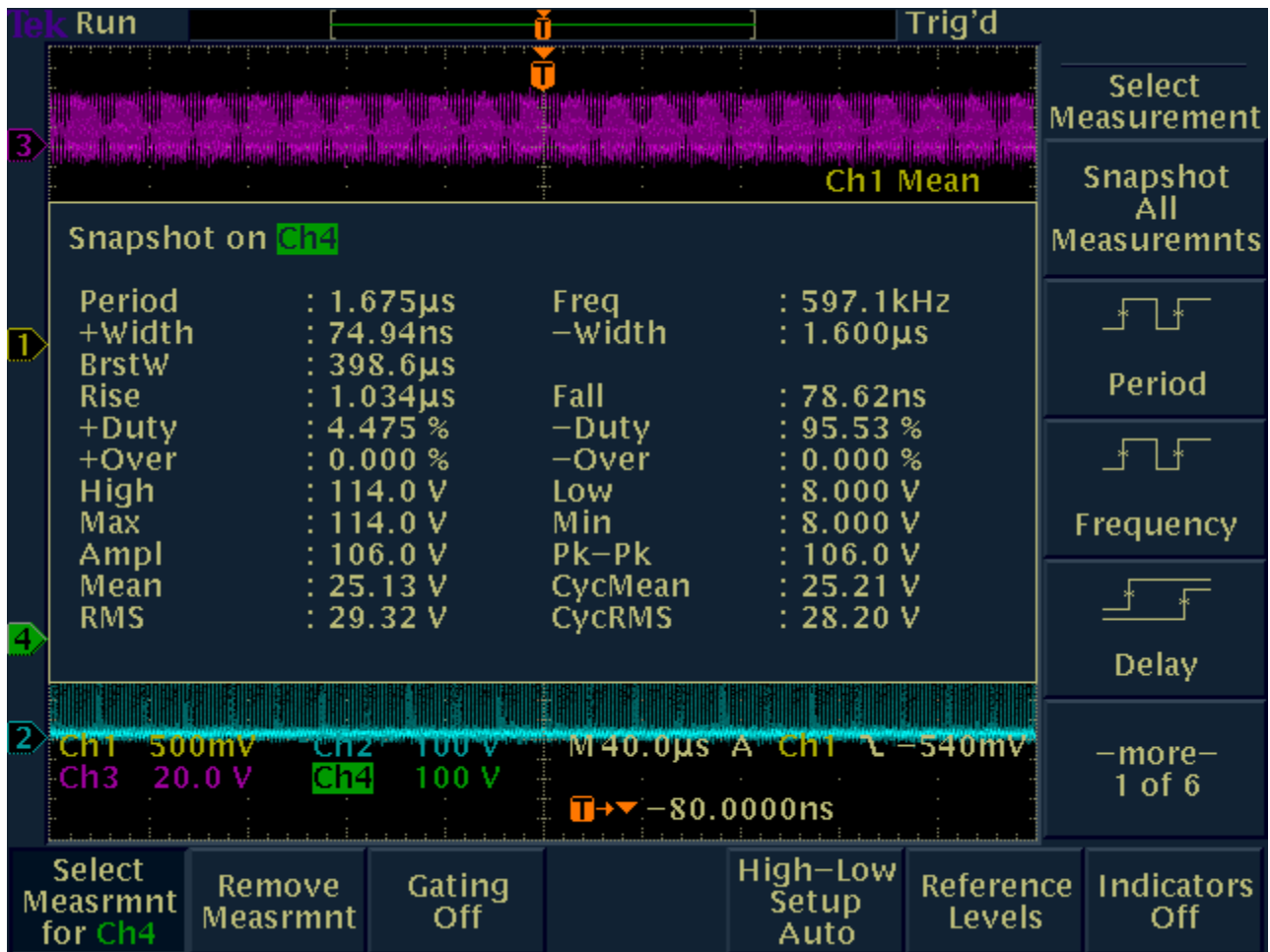

+4 Hours



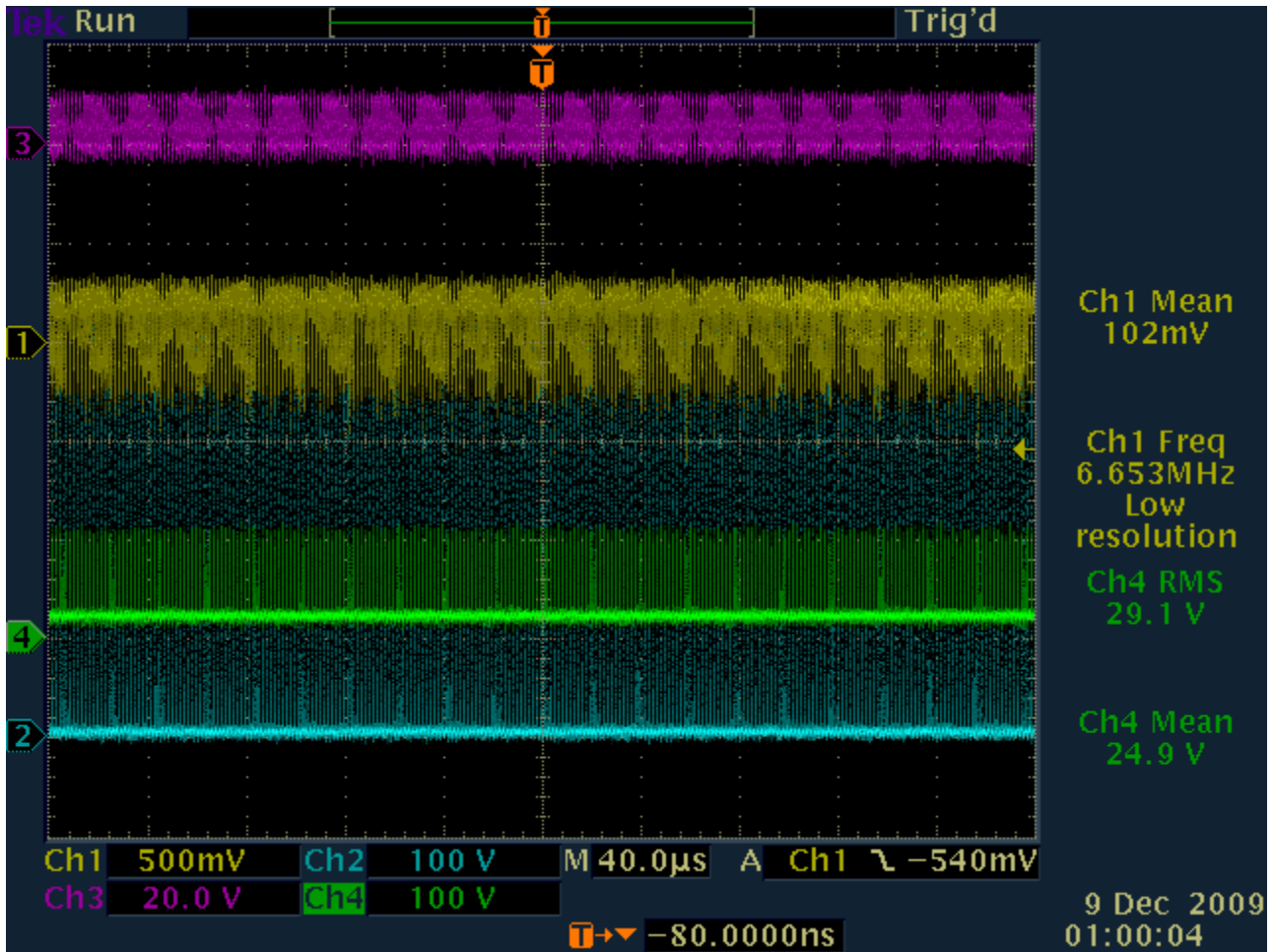

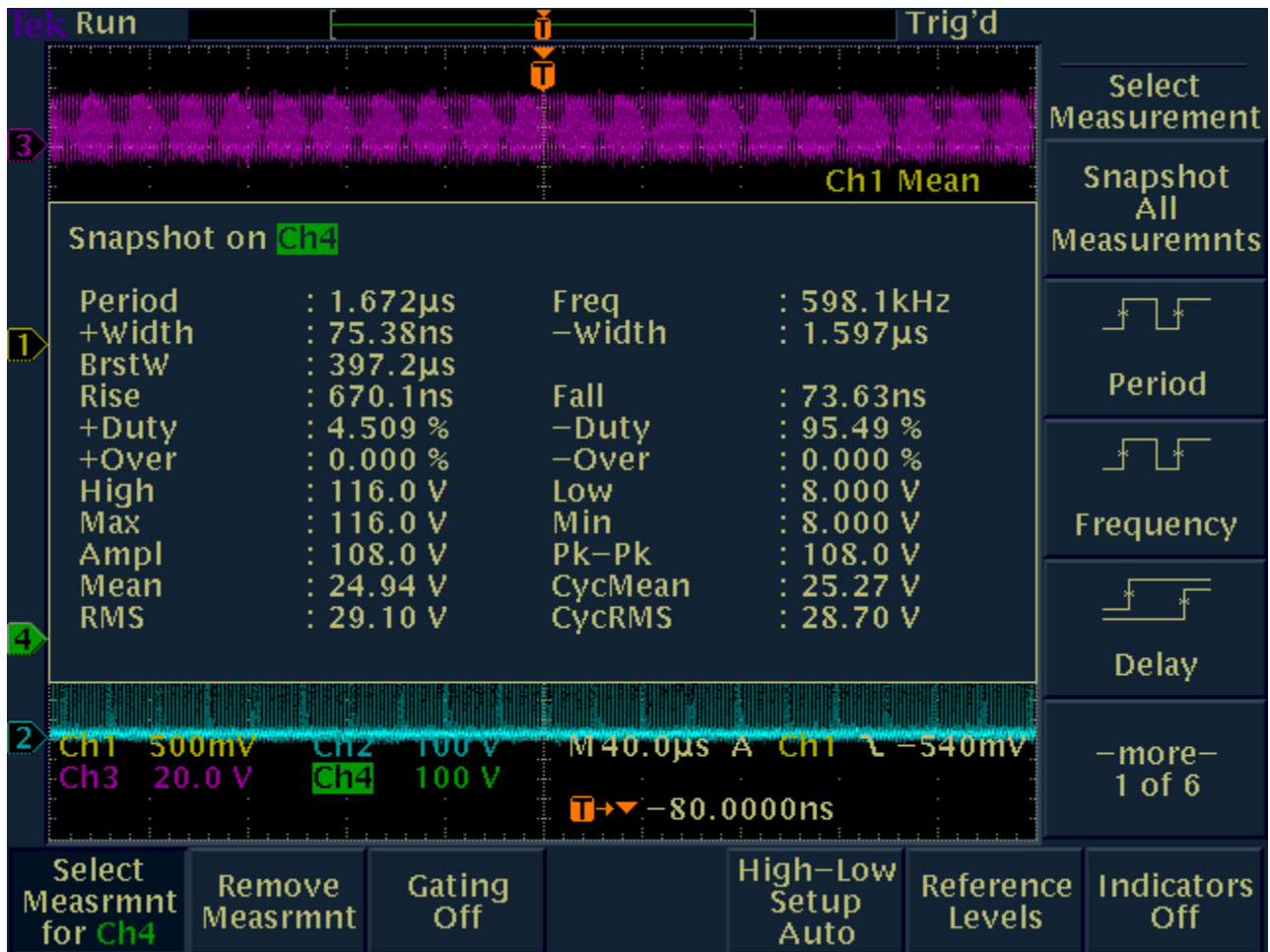

+5 Hours

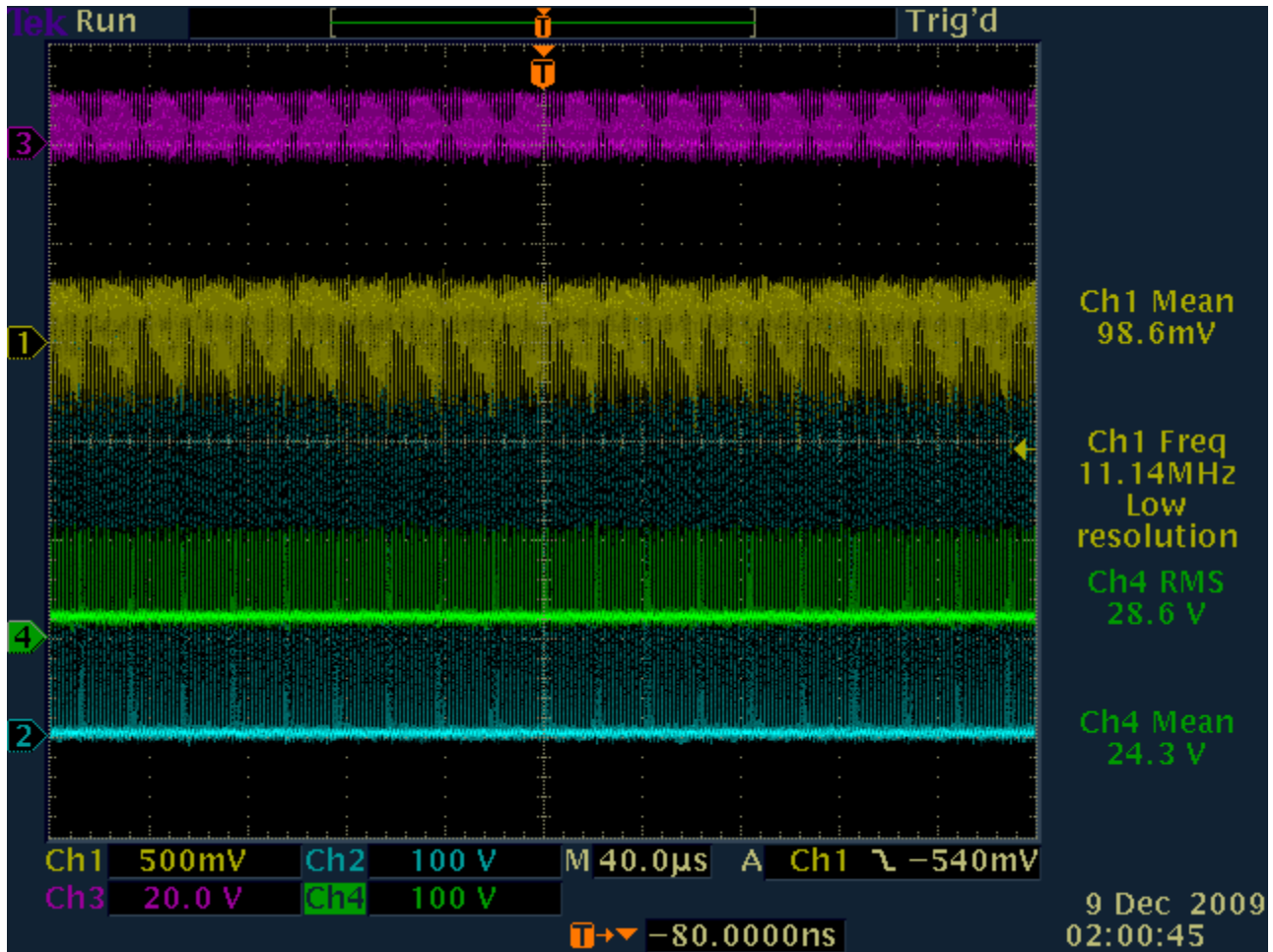

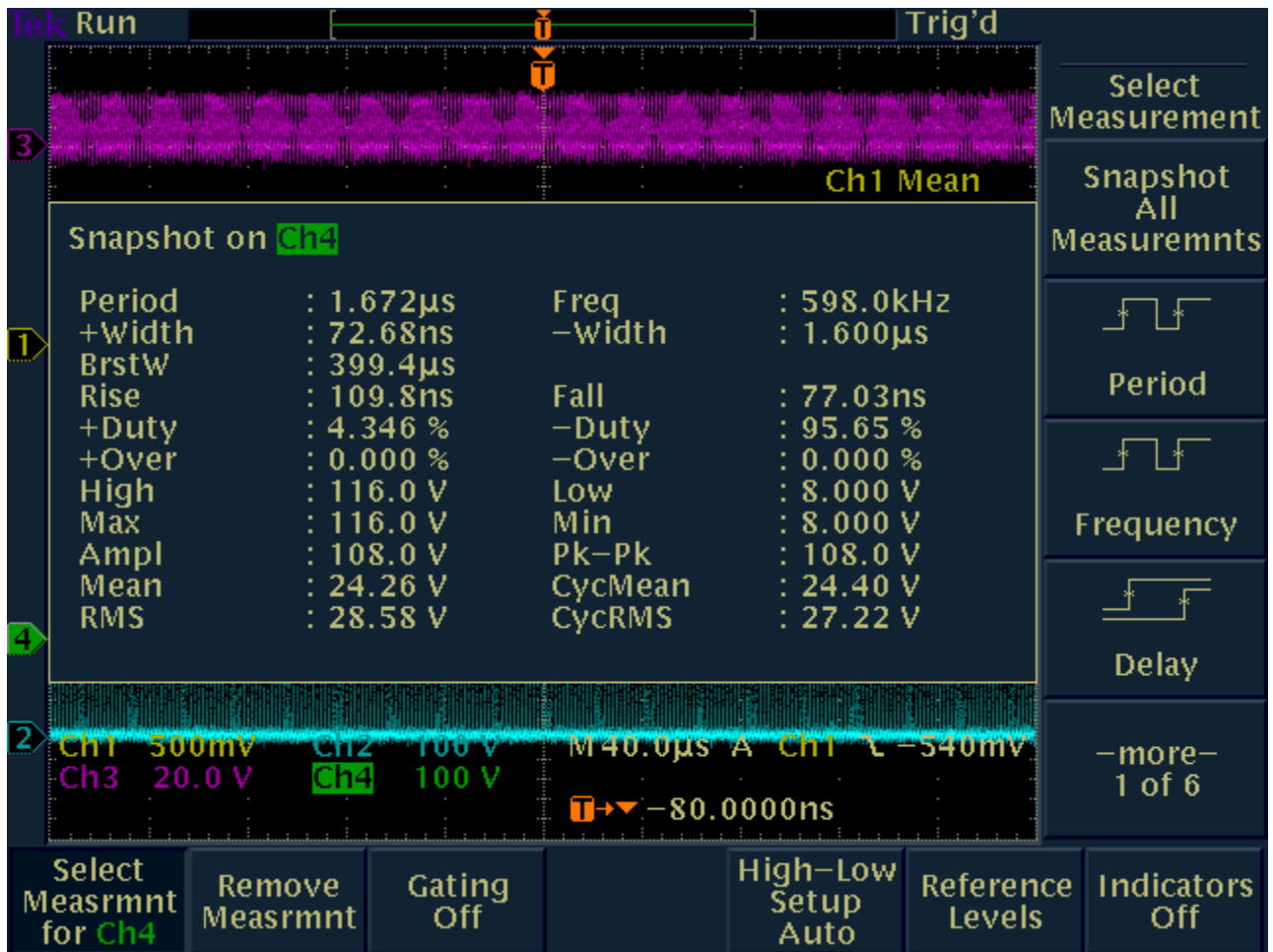

+6 Hours

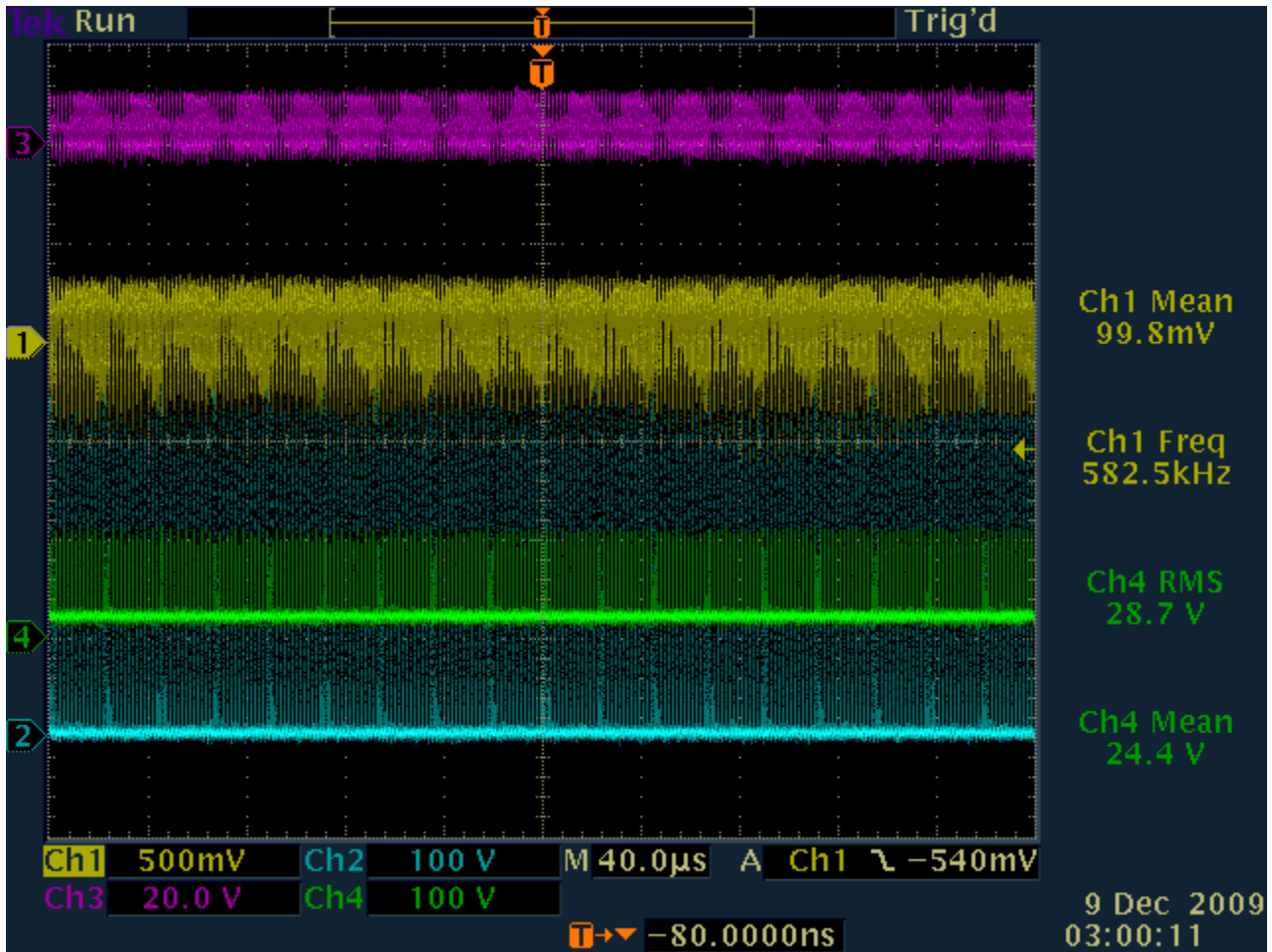

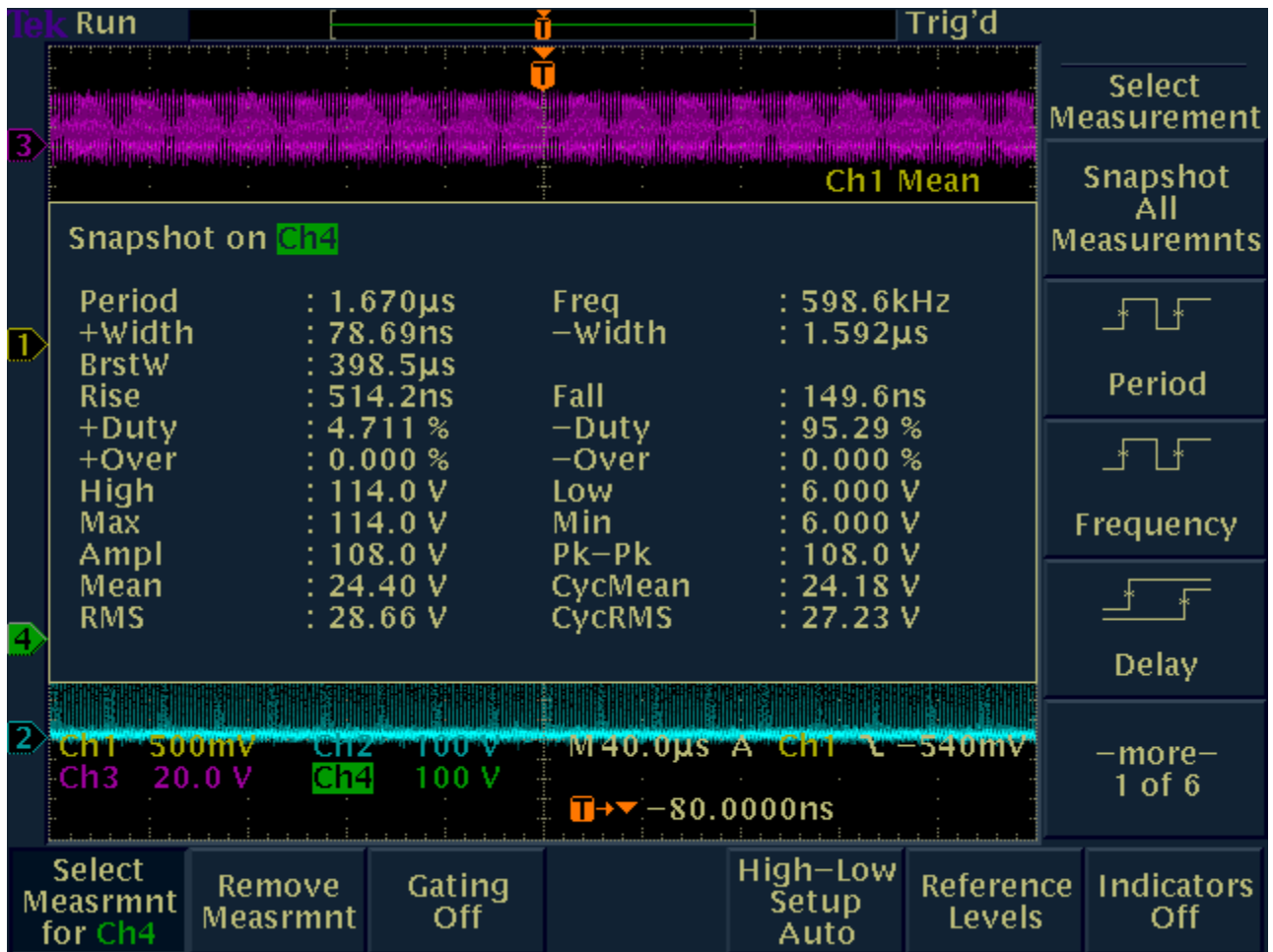

+7 Hours

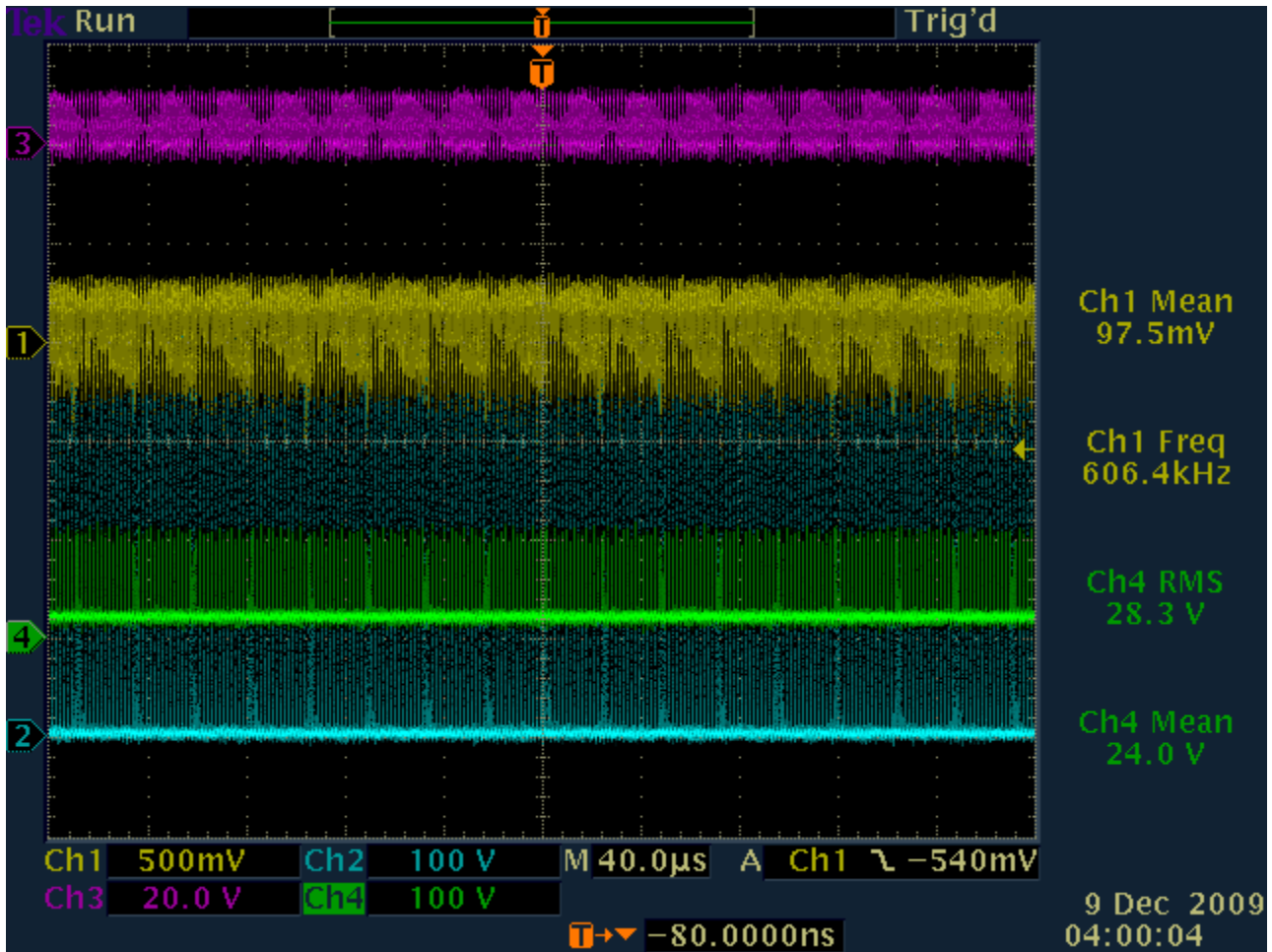

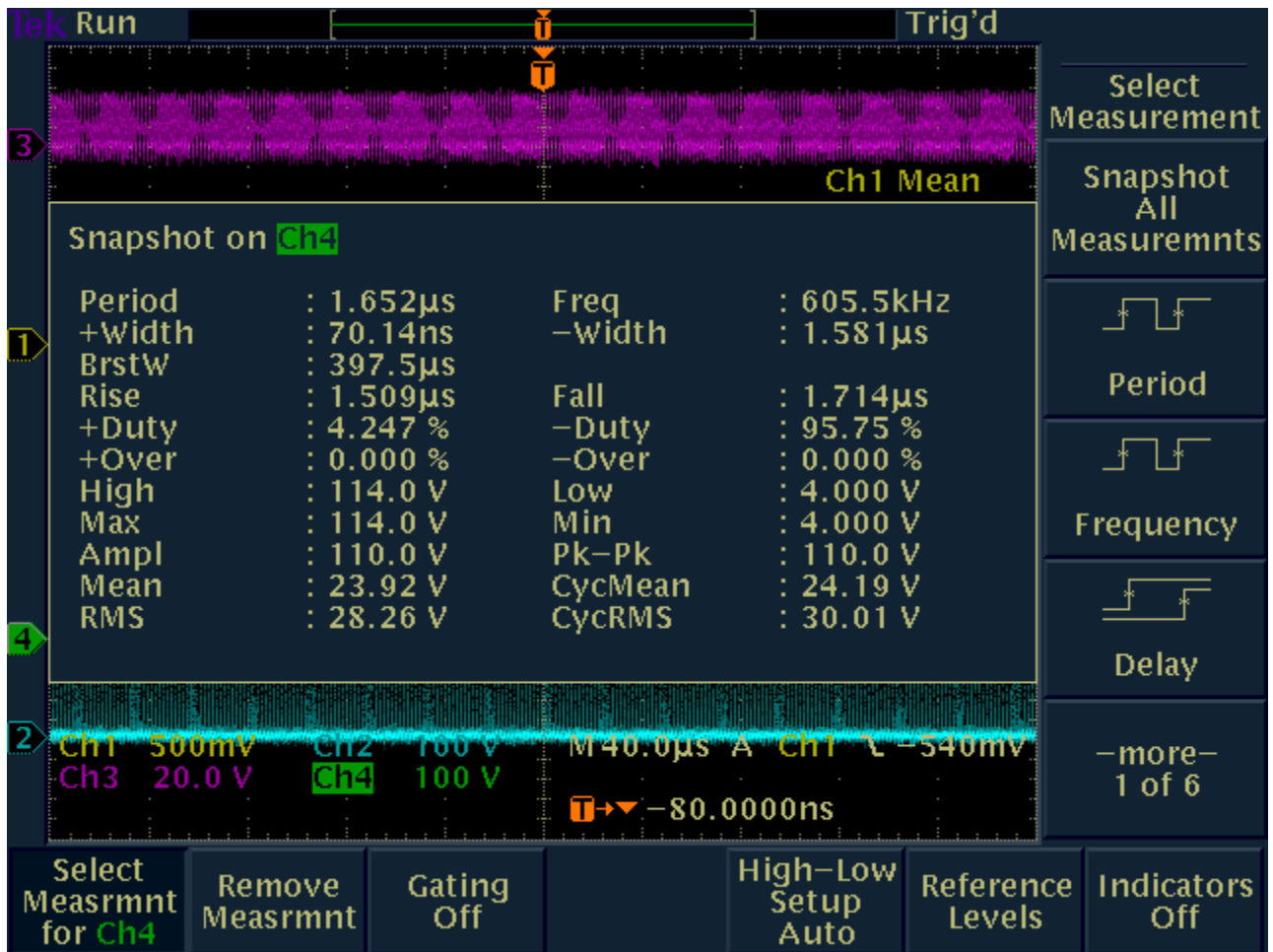

+13 Hours



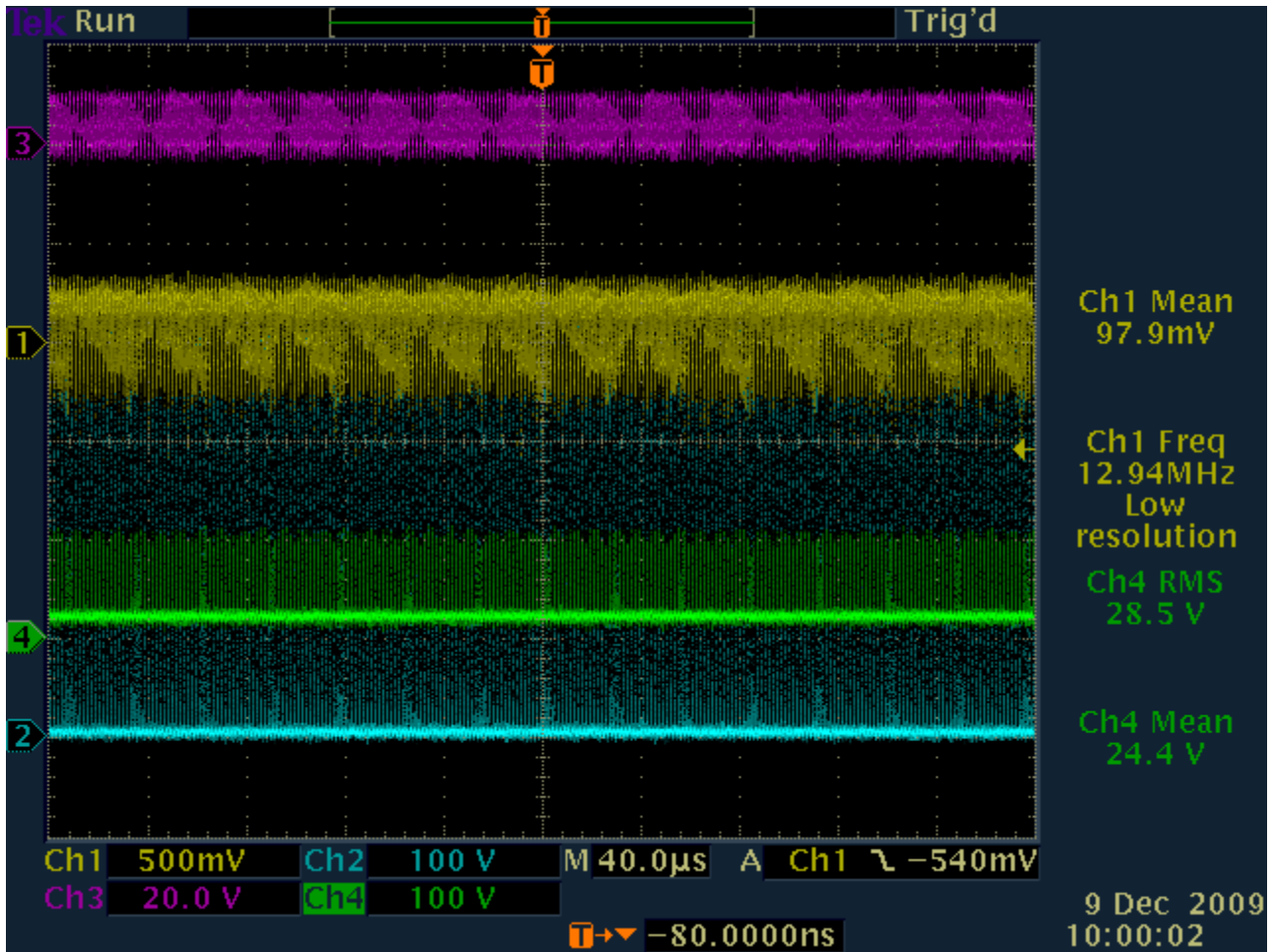

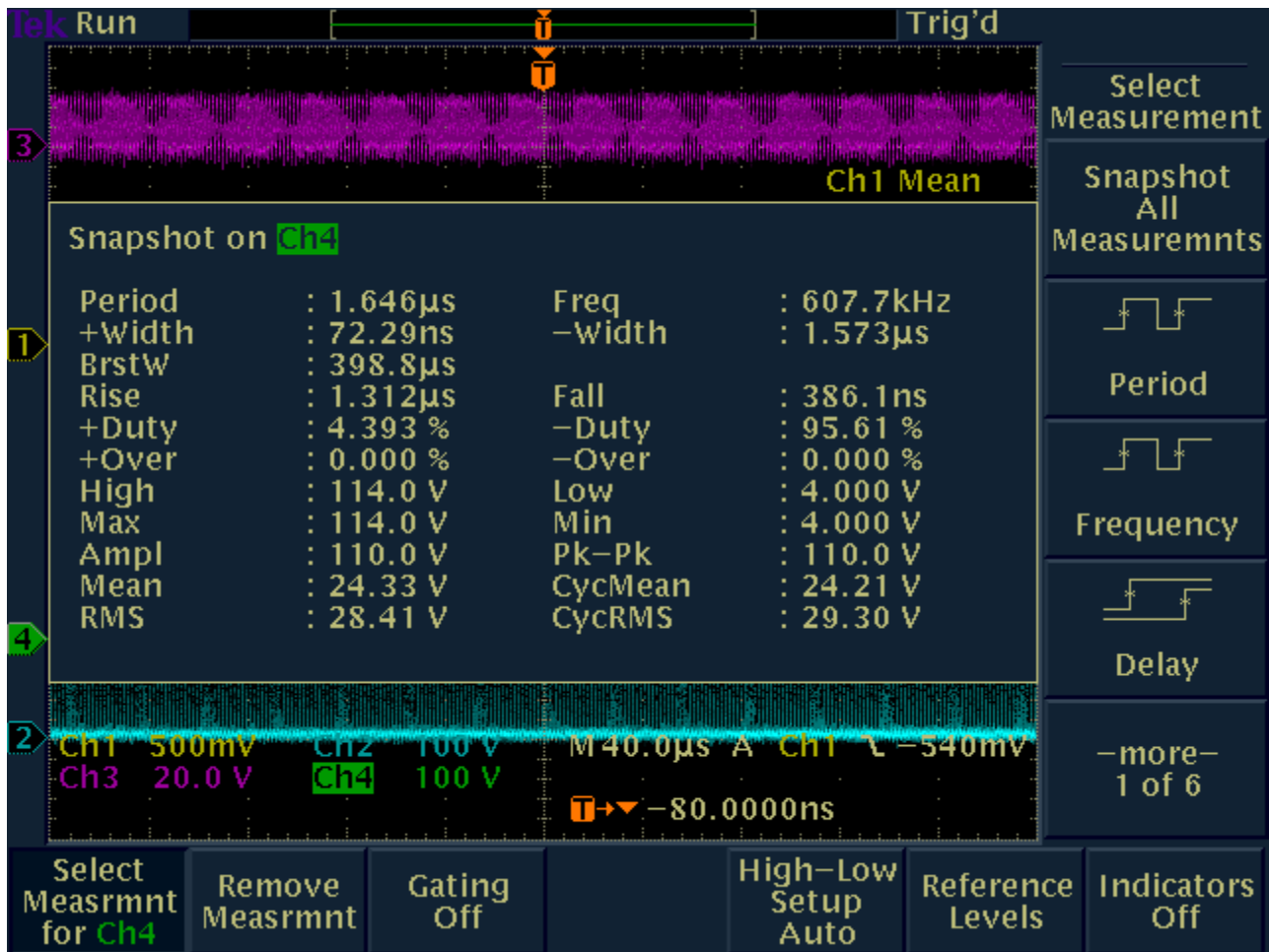

[Glen's Rosemary Ainslie COP>17 Heater Circuit – DATA TEST #16](#)

[DATA TEST #17](#)

[Test17\\_Master\\_Worksheet\\_\(version\\_2\).xls](#)

[DATA TEST #18](#)

[DATA TEST #19](#)

[DATA TEST #20](#)

[DATA TEST #21](#)

[DATA TEST #22](#)

### **Rosemary Ainslie COP>17 Heater Circuit**

There are many replicators out there that are asking how can I do this with my older oscilloscope that is 10mhz to 150mhz. well it's not easy but you can definitely get in the

ball park for sure. The resistance on the gate pot needs to be between 7 and 3 ohms using a DMM across the pot terminals 5 to 6 ohms for Best results-The battery voltage across the 24 volt battery bank can be monitored with another DMM and tuned to the highest voltage using the gate pot for fine adjustments between the 7 and 3 ohm area.

The **Channel 1** is used at the Mosfet shunt area between the 0.25 ohm resistor and the Mosfet "source" pin, "SCOPE" - set at 50mv and probe at X10

The **Channel 2** is used at the 24 Volt battery bank positive and negative but connected within 18 inches from your "load resistor", "SCOPE" - set at 2v and probe at X10

The "load resistor" will be from 110 degrees F to 150 degrees F

The "Mosfet" will be from 140 degrees F to 160 degrees F

( temperatures measured with a IR non contact thermometer )

**If using these setting this is what should be seen .**

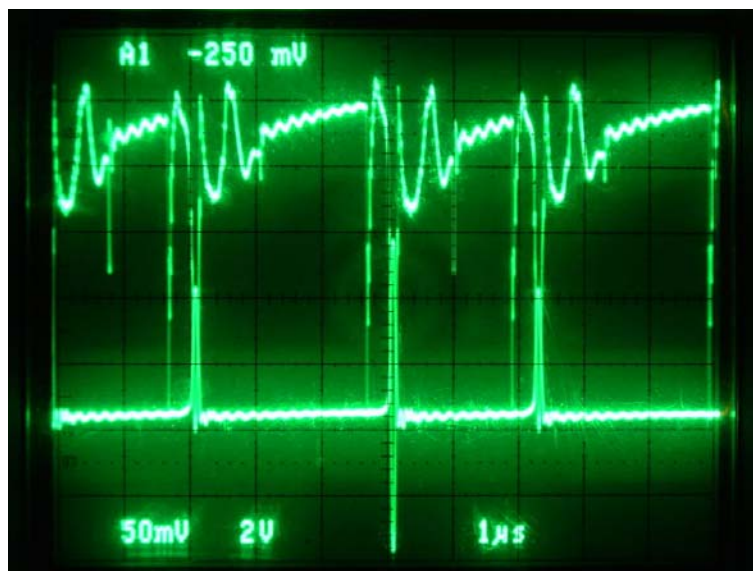

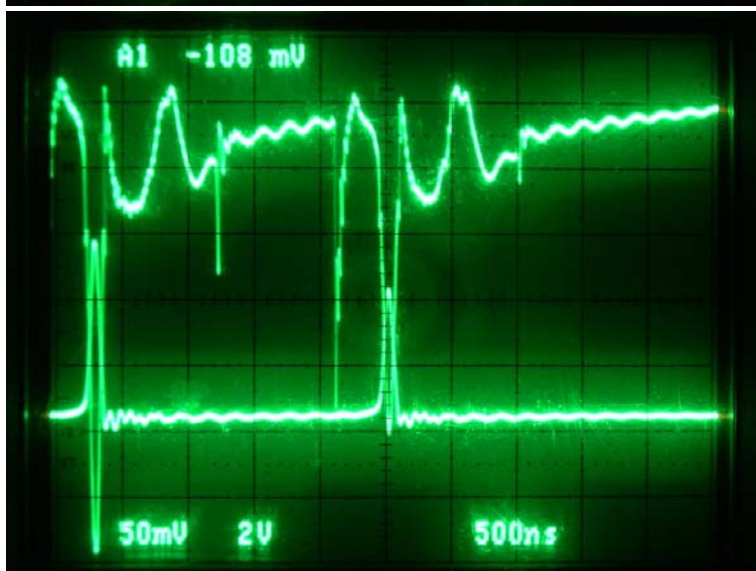
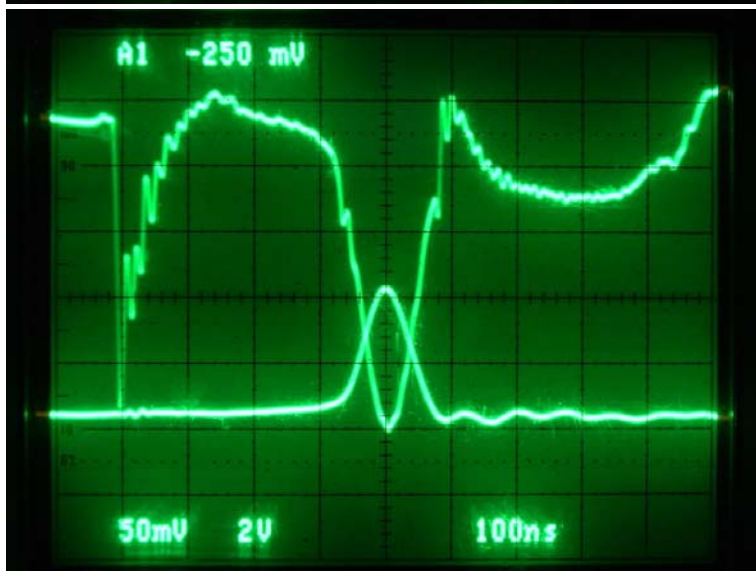
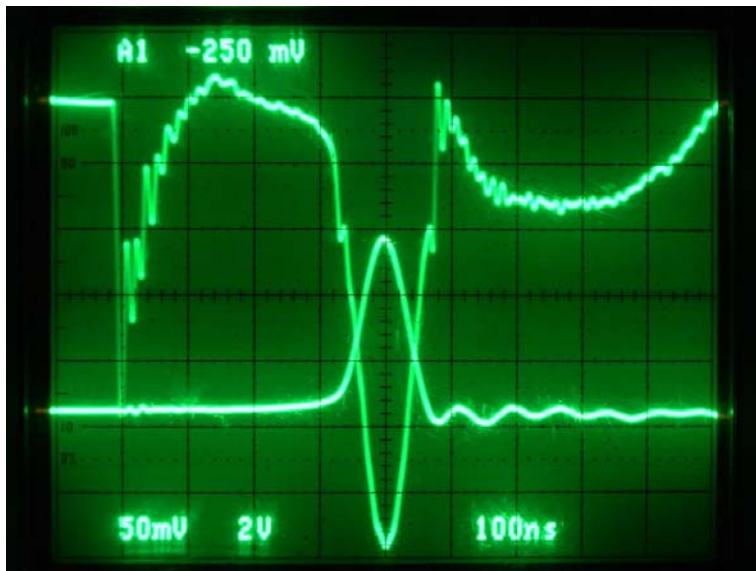

### A example of a earlier run using the Tektronix TDS 3054C

Channel 1 - Mosfet "source" shunt

Channel 2 - Mosfet "drain" \*

Channel 3 - 555 timer / pin #3

Channel 4 - 24 Volt Battery Bank

As you can see the Mosfet Drain @ 520 Volts rises at the same time the 24 Volt battery bank rises to 70 Volts

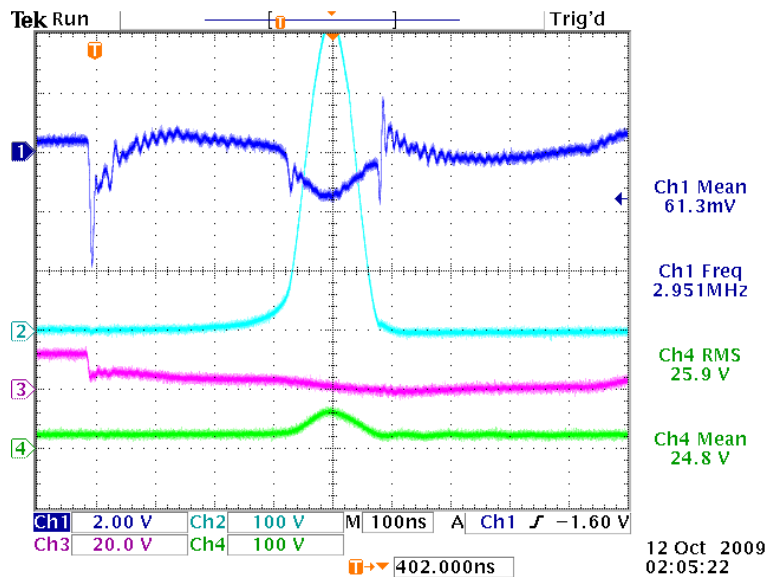

I hope this helps all the replicators out there so you know this can be done and get some impressive results yourself.

### Measuring Heat by Glen

At The present time my only method is to do temperature measurements in ambient air using a Fluke 62 "mini" IR thermometer to do surface tests of components and using the "Maximum" temperature reading on each component for recording purposes although I have shown a alternate method for my prototype [Quantum 10 ohm "Load Resistor"](#) a method in a earlier posting here at Energetic

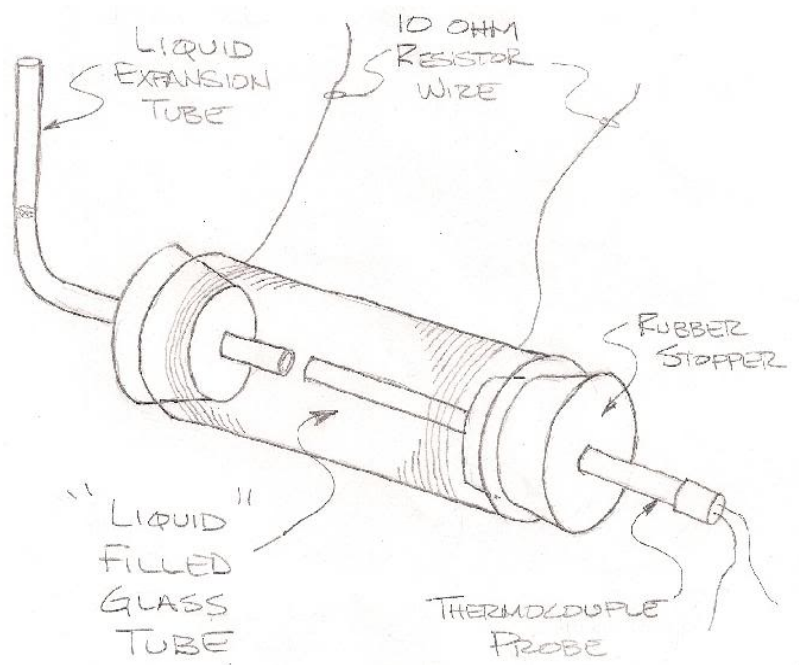

**Glen's "Quantum" 10 ohm Prototype Temperature Profiling**



Here is the temperature profiling data on the "Quantum" 10 ohm Prototype load resistor that has been used in several of my posted tests. All temperature readings were taken covering as much as possible of the exterior surface of the resistor with a IR non contact thermometer using the maximum reading.

POWER SUPPLY -Velleman PS3003U 0-30 VDC 3 Amp Regulated  
 IR non contact THERMOMETER- Fluke 62 "mini"

24.0 VDC " 10-ohm QUANTUM PROTOTYPE " TEMPERATURE LOAD TEST

VOLTS "DC"	AMPS	10Ω Ω	AMBIENT °F	WATTS
4.8	.50	107	73.5	2.40
5.0	.52	110	73.8	2.60
5.2	.54	114	73.9	2.81
5.4	.56	116	73.8	3.02
5.6	.58	118	73.6	3.25
5.8	.60	120	73.8	3.48
6.0	.62	122	73.9	3.72
6.2	.64	125	73.8	3.97
6.4	.66	128	73.9	4.22
6.6	.68	131	74.1	4.49
6.8	.70	134	74.1	4.76
7.0	.72	137	74.2	5.04
7.2	.74	139	74.3	5.33
7.4	.76	142	74.7	5.62
7.6	.78	146	74.9	5.93
7.8	.80	148	75.0	6.24
8.0	.82	153	75.0	6.56
8.2	.84	155	74.9	6.89
8.4	.86	157	74.5	7.22
8.6	.88	159	74.5	7.57
8.8	.90	164	74.6	7.92
20.0	2.05	323	73.8	41

**Tips by Harvey**

Here is the data sheet for [Bostik Matrix FC](#). This is a thixotropic polyurethane. A thixotropic gel relates to how the material is applied and essentially reacts like the inverse of a non-newtonian liquid in that it becomes 'thinner' (more liquid) when stirred or agitated. I would hope this is not the case after it is cured as certain conditions in these coils can lead to recursive [microphony](#) and that could liquefy your material.

You will note that the maximum service temperature is 80°C while some polyurethanes are actually used as thermal insulation (See <http://www.assanpanel.com.tr/en-us/Q...s/Attach.1..pdf>) Like Glen's Silicone covering, the real temperature of your resistor wire may not be making it out to the outer surface of the material due to the very low

thermal conduction and very high heat capacity of the material. I might add here that the original Ainslie group had temperatures over 50°C above ambient (~20°C) so your material is at its limits if these conditions were to surface.

You also have two other factors of importance. You have used a stranded insulated wire. We do not know what the insulation material is around your wire, but if that wire is a type of heater wire then the insulation is probably a silicone material. It could take days of constant heat for your resistor to fully equalize and present the correct temperature to the outside world depending on how far the wire is above ambient. Next we would need to have a look at the stranded wire specifications to determine how current through the wire relates to heat. A chart like [this one](#) is helpful in determining the expected temperatures due to current flow in a tightly wound coil of the material.

Rosemary contends the energy observed as increased heat (above that expected by current flow) is partially a result of matter fluctuations which increase with the mass of the wire. So according to her thesis she expects there to be an increase in heating as the wire size is increased. This result is counter intuitive because classically we expect the heat to be caused by resistive means. Where her case could be partially supported by the classical Joule heating in the cross section of a thick wire while current flow on the skin produces the necessary induction, we are still left to determine the source of the surplus heat that seems to be present.

Also, I might draw attention to your ferrite core which also serves as a thermal sink and radiator and can adversely impact the expected temperature.

### **Advantage of making your own resistor by Rose**

Guys - here's a synchronous event that has to defy the odds. 10 years ago when I was trying to put this circuit together I knew nothing about inductance - resistance - or indeed anything much. I was looking for a resistor and simply shopped for the biggest diameter with the thickest wire that I could find. I think Harvey mentioned that this is usually his criteria for grocery shopping. Back then all I wanted to do was generate as much counter electromotive force as I could and - big seemed better.

Then the results - that crowded in around this were unarguable and widely accredited. But still - wherever it was advanced on any theoretical basis it was met with skepticism - notwithstanding the evidence which then was still demonstrable. I was entirely unable to advance the technology. Then, on these forums the same thing. Rank skepticism - and more of it - and only small evidence of gains. Then Fuzzy made his own resistor and used the only reliable criteria available being the diameter of his resistor. The wire, the windings and the rest of it were developed on a 'best guess' basis. But his resistor seems



to have cracked that elusive barrier. I am wondering if the effect need that wide space inside the coil and somehow - hamper this - and the effect goes away. Just a thought. If so, then it's no wonder that the benefits here have eluded detection and for so long. And then too, it would explain the rank disbelief that was the unhappy reaction to our own claims. Perhaps Fuzzy can explore a resistor with a smaller diameter and check if this can reach that same optimized performance.

### **From Aaron**

#### **Ainslie circuit without caps on 555 going negative**

Some people amateurishly believe the negative effects on this circuit come from caps on the 555 circuit. Even if they do, it is still unconventional and there is still more leaving the circuit than going into it. In any case, this video shows no caps on the 555 circuit at all, and yes it will run, and the negative effects are still there. So, the argument that the effects are coming from the caps are completely erroneous.

#### **[YouTube - Ainslie circuit without caps on 555 circuit](#)**

The cap is like a vacuum cleaner for the spike, it drops the potential difference greatly and the battery seeds a small thud. Not a sharp impulse. You seem like you aren't familiar with how a coil rings out. Let me tell you. The middle of the pos/neg amplitude of the ring is the zero voltage point and not the mid-line on the scope. I raised the wave to the top to get the best view, the rest...you're right...is common sense - the common sense tells you where the zero line is even if there aren't any lines on the scope screen. So realize that even though you're making me work harder to show the facts, nevertheless, all you're doing is demolishing your own premise at the same time. The spike reduces what the input pulse delivers. AND, the oscillation cancels itself out.

Don't tell me I don't know how to use a scope. I do. And I know exactly what the waveform shows. EXCESS HEAT IN THE INDUCTIVE RESISTOR thanks to the ringing. PLUS CHARGING IN THE SUPPLY BATTERY thanks to the spike.

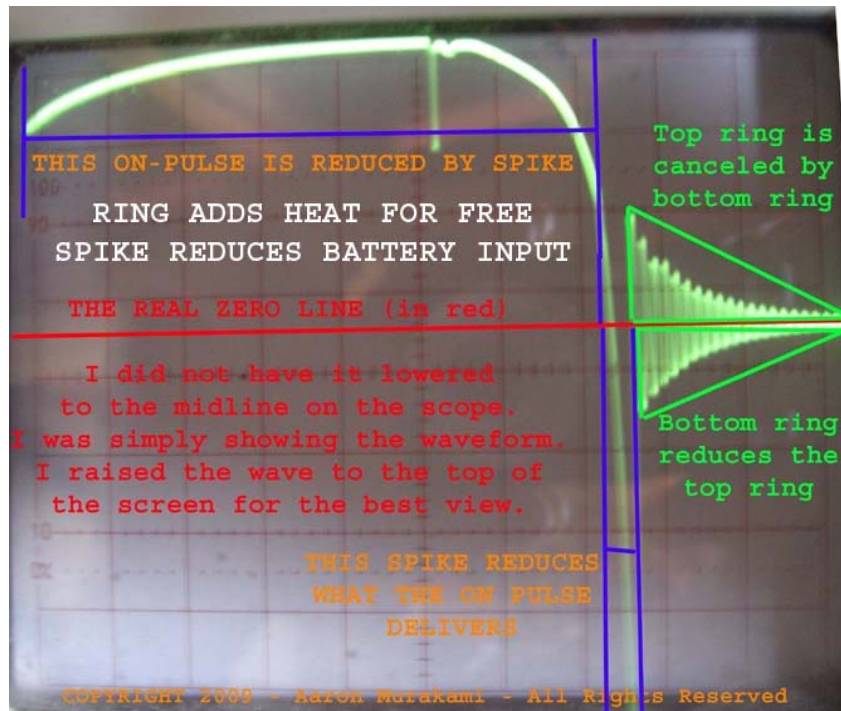

if you look at my pics, the pot for the signal is literally soldered directly to the gate pin on the mosfet. I'm using the same type of mosfet Rosemary used. So it is short. I have a Bourne's precision 1k pot on there now. It is a 10 to 15 turn pot. Extremely precise with ultra low error margin. The radio shack one is gone. I'll post pics. Good recommendation though. I'll shorten the length from the timer to the gate with precision pot in between.

Shortening breadboard connections, also a good recommendation. Not sure it will make much difference because the mosfet is getting a very good strong signal. But I'll do some of that next time.

The mosfet gate resistance modifications - the mosfet will get hot if there is too much resistance. It becomes a variable pressure valve for voltage and too much resistance locks in too much back pressure and that makes heat.

Too little resistance gets too chaotic and too high of positive spikes. A little resistance is good, different for everyone. Too much rounds the pulse too much, the mosfet turn off is slowed, the spike reduces and the rings (free heat) disappear. But with little resistance, the heat is insignificant (in the mosfet I'm talking about, not the resistor).

#### **From Dr Stiffler**

I think what we need to do is look at the issue of battery charging like this. Today I take \$2 from my piggy bank, spend \$1 and put \$1 back into the bank. Next day I do the same thing. Yes indeed I may be making deposits, yet I continue to decrease my bank

account. I made a post some time back where I said its how you look at it, your bank account is 1/2 empty or it is 1/2 full.

I can not in any way see how the return (collapsing) pulse is going back into the battery, I see it as going back into the coil. The reverse biased protection diode (Zener) in the MOSFET wants to see a negative pulse in order to conduct. So the problem, the FET is off and the coil field falls trying to keep the current flowing in the same direction, shunting back through the 1N4007 back into the coil. Now looking from ground reference the Drain is still positive and not negative, so the internal protection diode should not conduct.

From Rosie -Dr Stiffler, this is the 'thing' that actually happens. The counter electromotive force coming from the load resistor is evident as a voltage spike over the load resistor ( also the inductor ). Only if you have a flyback diode going back to the battery does one get the benefit of that spike.

This is easily proved. Take a battery as the supply source to drive the circuit. Take a second battery and link it to the first only on the negative rail. Then take the feedback diode and put it on the positive terminal of the second battery. You will see the second battery recharge. If you use a fully charged battery as the second battery it will still recharge. We've taken a fully charged battery 12 volt battery to plus 17 volts in the space of 15 minutes.

But quite apart from this - academics themselves have advised me that the way to compute the energy delivered by the battery is the difference between the two parts of each duty cycle. This has never been brought to question. I was given the measurement protocol - not by one but by many recognised experts in the field. And they are right. Because the rate at which a battery actually discharges its energy is consistent with the sum of or as I've pointed out, the difference between the energy measured in both cycles. The one cycle discharges the battery. The second recharges provided always that the voltage spike is greater than the source battery voltage and the resistance of the load resistor itself. That level is not difficult to attain with counter electromotive force from the collapsing fields on the resistor itself.

If required I will get this comment approved by an academic. I happen to know quite a few. And they are not averse to answering these types of questions. This point goes to the heart of the thesis.

### **Common measurements**

From Dr Stiffler -In order for the thread to not go on into infinity and nothing really answered, we all need to decide on a common circuit. Now if all cannot use the Inventors circuit for whatever reason, then it should be possible to at least setup a table of procedures so that everyone can present his/her data in the same way.

If we do this it will be possible for all to see at once the energy balance of a circuit. Maybe some of the replicators are not able to do integration either manually or from equipment, but if scope shots using the same scan parms then there are a number of people that are here or at least watching that can do it from the properly presented data. I'm sure Dr. Lindemann and Aaron can if asked and presented the correct info. So many times these things go on forever and no one setups up the correct procedure for reporting. This is where everyone does it different and everyone is confused.

May someone will offer to present a common diagram that all can follow or at least a block diagram which can call for numbers from measurement and all can at least supply numbers in a consistent way.

Anyway lets get this done, people waste a ton of time and money on parts and maybe even equipment and the answer never seems conclusive.

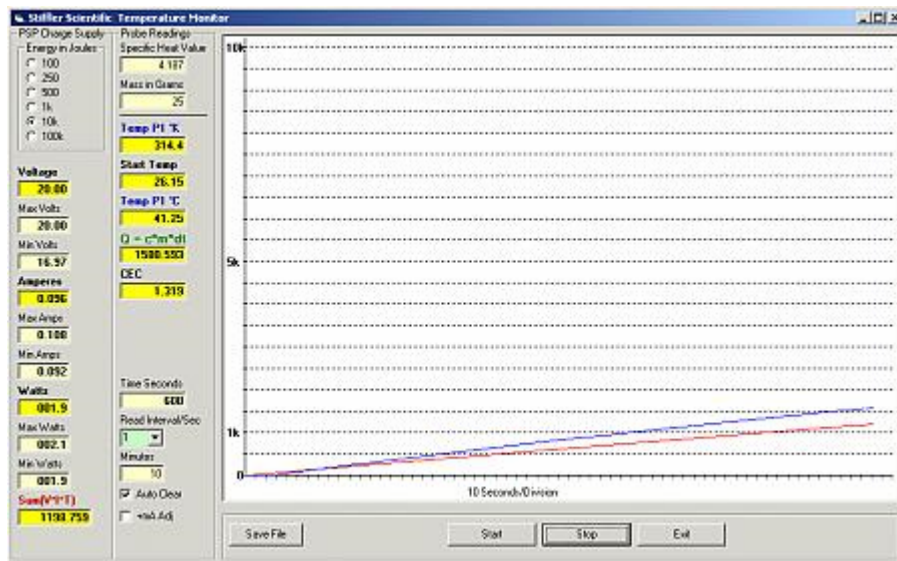

I find it totally appalling that this thread is so diluted by 'Tech-Nots', the group of people for whatever reason and many times (no real reason) are attempting to take over and cause failure. I applaud Ms. Ainslie for holding her own when attacked by such dis-functionality.

Now another topic. Ms. Ainslie you asked a question about which the cause might be found why there has not been prior awareness. You did ask a couple specific gentleman, to aid in the answer I hope you will not be upset if I make an attempt? I took the question to be more philosophical than technical and can offer from my own experience of so 50 years in the RF field.

Our classical education has a (large) number of rules of thumb so to speak, (they call it

laws). One specific one is anomalies and artefacts outside of their narrow realm. The treatment is to filter everything out, bypass, restrict and totally eliminate. As an EE I would design with a margin of error (say for resistor wattage) and the cost engineers would reduce it back down to save cost. Anyway if we experienced a continuous set of failures it would be assumed the cost boys were at fault and the part was bumped back to the specification.

Never in my career did I ever or did I ever hear about doing calorimetric. If oscillation were present, you never explored them, you engineered them out. For you I have included a picture I was able to get from a run this AM and its from your circuit that is far from optimal, yet I would think it will help you in the battles you are yet to fight. 26.15°C -> 41.25°C in 10 minutes and the divergence is self evident.

### **Battery Charging by Rose**

The measurement of the total energy delivered by the battery is the amount delivered - less the amount returned in that spike. The tricky thing is to compute the energy in the spike.

The amount of energy in the spike is invariably some fraction less than the input. But if you work on one third of the input you've way understated the actual return. But work on that number. You'll already see a gain that goes through the roof. Can you get a scopemeter that can determine that energy on a dc coupling? Otherwise - can you just measure the voltage rise on two batteries - as I've explained. One battery to run the test. A second linked only at the negative terminals of both batteries. Then take voltage readings of the second battery. I promise you - you will see a dramatic recharge at low duty cycles. And there will be no evident decrease in the output over the resistive load. Try using a light for the resistive load to show this.

Regarding battery draw down tests, here's the thing. All batteries have their own vagaries. And the known chemical interactions at recharge and draw down appear to be a really complex art all of itself. However, our own tests as defined and required by BP more or less dealt with vagaries by using the following.

- Same battery types in all tests.
- Controls run at the same time as the experimental test.
- Test period defined when one or other of the two tests showed voltage at 'tumble' level - usually at 10 volts or thereby.
- Tests stopped - both tests batteries recharged simultaneously from 1 recharger
- Test battery to control - control battery to test and then a re-run

That way the batteries on both tests are subjected to the same stresses as each other and the weighted benefit to the control rather than to the test. I've learned that it is apparently not good to let the batteries drop below 11 volts. Have no idea why this should be the case. I have never found any degradation of the batteries' watt hour ratings. It may be something to do with what Aaron has suggested that the 'spikes' have some sort of benefit that is not considered mainstream. Whatever the explanation - I have never - before today - realized that it could be considered harmful to run a battery flat and have never found it to be the case. And I have tested batteries just so often.

Another point. It is a typical phenomenon on these tests, whether with or without a flyback - to see the test batteries' voltage climb. I think this would be in defiance that there is no actual benefit to the 'spike' - or that it's actual return energy to the battery may be insignificant. And Luc's tests also show this battery idiosyncrasy compared to his controls.

And another point. The model requires that 'charge' is wholly conserved. This therefore (edit) 'theoretically' allows for a recovery to a battery's full charge potential. Energy dissipated within the circuit is a secondary event - also in terms of the model. And at the risk of confusing all readers more thoroughly - the model's 'take' on current flow is described hereunder in really broad brushstroke.

The battery is connected - it delivers current flow clockwise - the battery is disconnected - energy is regenerated at the resistor - it delivers current flow anti clockwise. The polarity of the body diodes permit this variation in current flow. There is no such thing as 'stored' current. Only stored potential difference - again - only in terms of the model. And potential difference is the required ingredient to allow current flow or any exchange of energy at all. In terms of the model - potential difference is a measure of asymmetry. Always useable.

So if PD is above zero current can flow clockwise - with no impediments. If the PD is below zero current can flow anticlockwise - with no impediments. If it is resonating - current can take its pick in direction as often as it likes and override the switch - as required. The trick is to get it to resonate by using inductive coil resistors. Curly wounds? I've heard it described as such.

### **Poynt 99 COP Test**

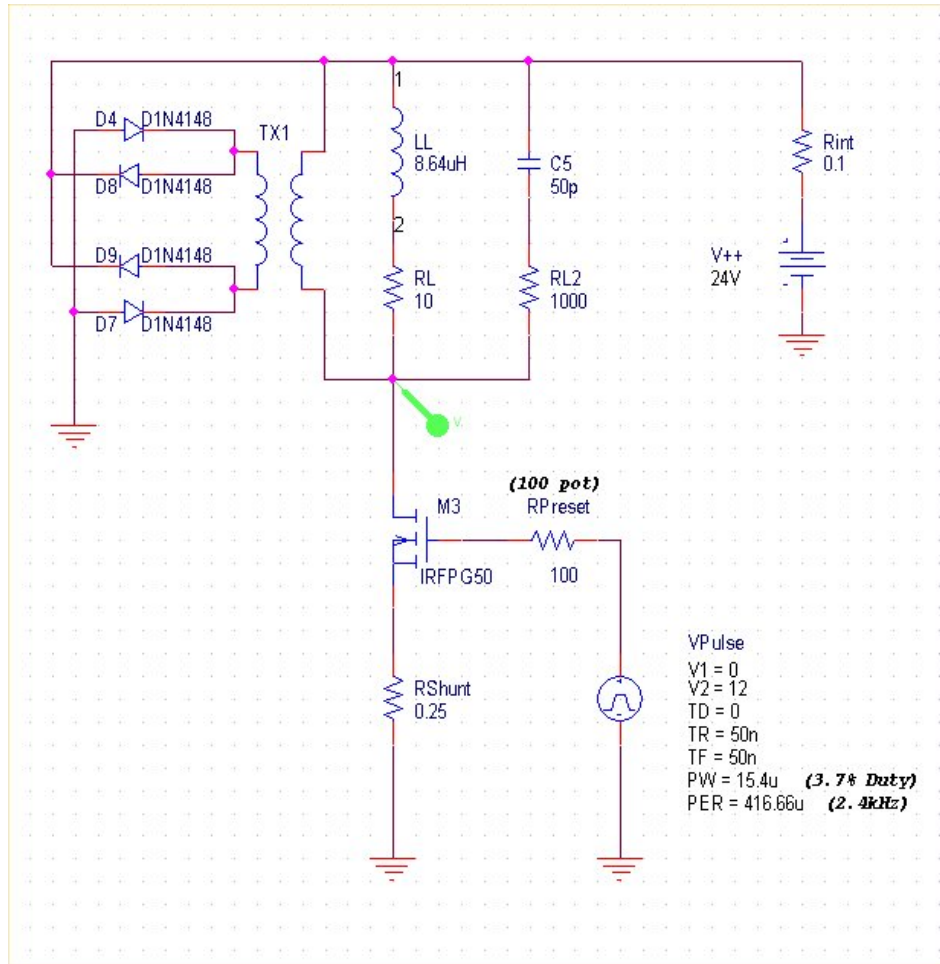

A proposed COP test. Rosemary asked for the schematic. HF capable transformer. Capacitor filtering on output would be optional, but not necessary. With COP>1.5 or so, should work in theory, if excess COP appears as usable V and I in the load to obtain real power output.

### From Alex (Groundloop)

**RF from the circuit** - Today I did a test to see how much radio frequency energy there was radiated from the RA circuit. Circuit version:  
[http://home.no/ufoufoufo/anc\\_revB\\_sch.gif](http://home.no/ufoufoufo/anc_revB_sch.gif)

Resistor: GRF20/100 10R 80W 6,5  $\mu$ H.

Power: Lab supply, separate 12.0VDC for 555 IC, separate 12.0VDC for Switch.

Frequency: 2,4 KHz at approx. 3-4% ON Duty Cycle.

Input: 12.0VDC @ 0,04A indicated on lab supply.

Shunt: 0,25 Ohm 1%, 10,7mV average measured with DVM.

Spectrum Analyzer:- Set to scan from 10KHz to 50MHz. Bandwidth 15KHz. Scan Step 15KHz.

- Pickup antenna less than 30mm distance from the 10 Ohm power resistor.

The scan did not pick up any RF energy above -80dBm. To give you a idea of the low RF levels, -70dBm is equal to 100pW (pico Watt). Conclusions: It is fairly safe to say that the circuit does not radiate any significant level of radio frequency energy to the surroundings.

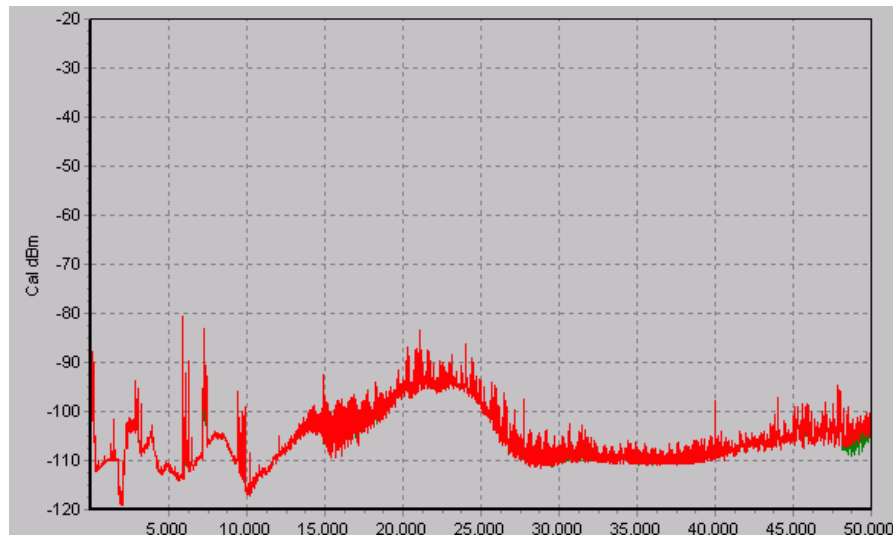

### **Free running oscillator test**

I wanted to see if a wire wound resistor was able to oscillate at all and also at what frequency it would oscillate at. So I designed this circuit:



## ROSEMARY AINSLIE FREE RUNNING OSCILATOR TEST

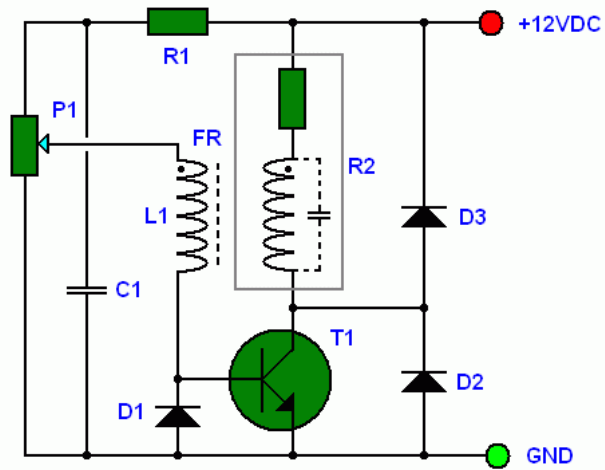

### PART LIST:

R1 = 18K 1/4 W  
R2 = 10 Ohm 80 W, WIRE WOUND 6,5uH (WITHOUT CORE)  
C1 = 330nF 650V  
D1, D2 AND D3 = BY255  
FR = FERRITE ROD 10mm DIAMETER, 100mm LONG, INSIDE R2  
L1 = 50 TURNS, 0,4mm ENAMELED COPPER, WOUND ONTO FR  
T1 = 2N3055 ONTO A HEAT SINK  
P1 = 10K LIN

Groundloop2003

The oscillator did run very well indeed. I made a Ferrite coil inside the load resistor like this:

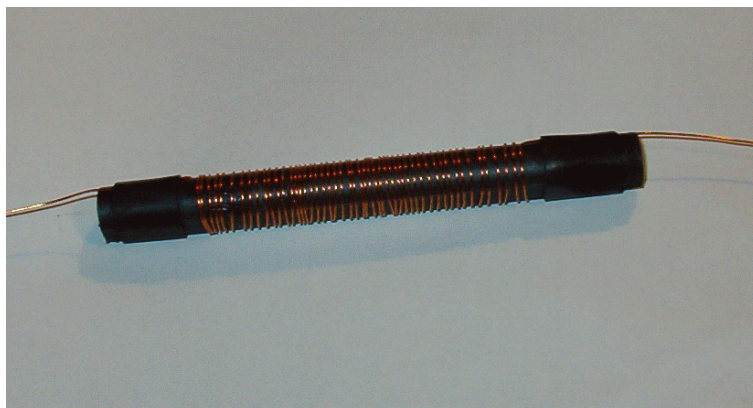

The o-scope is showing an oscillation:

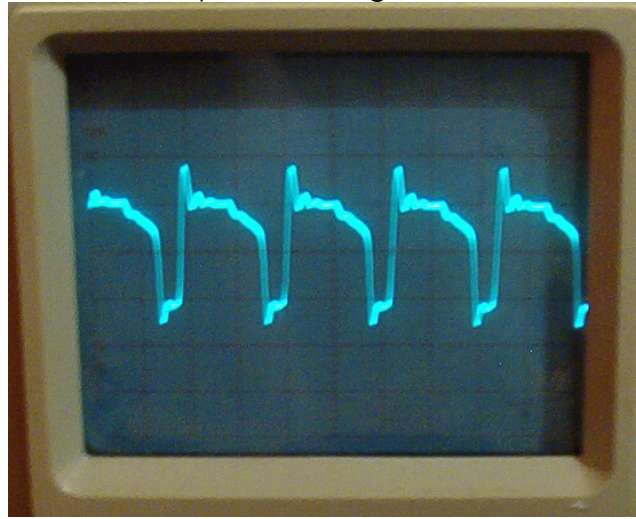

The frequency counter said that the frequency was 966.567KHz :

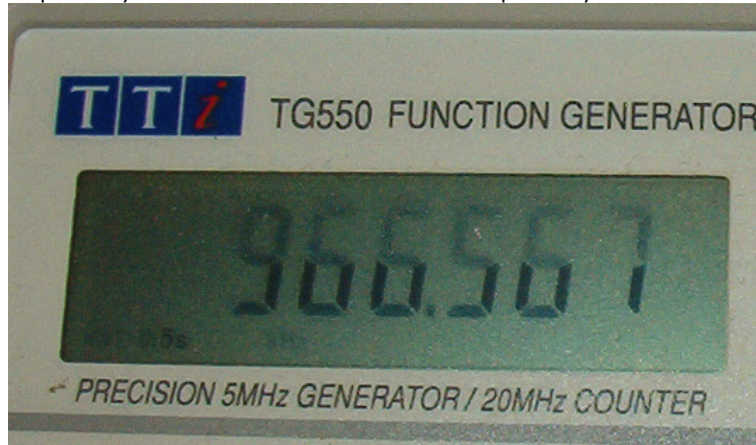

The finished unit look like this:



I did not use any external capacitor across the load resistor.

### **From Harvey**

Negative Before Positive -Just a quick video showing a classical approach to producing negatives before positives: [Negative Before Positive Simulation](#)

### **Circuit proposed by Lighty from Aaron**

Here is the proposed schematic from Lighty. I have not had time to try it yet but I will try the recovery part of the circuit with some of the diodes I do have on hand. I have to make an order for a few different mosfets like the one shown or a IRFP450 and some diodes. I have everything else.

If anyone tries this out before I get the parts to do it myself, please post the results. Being able to optically isolate the load side of the circuit from the timer makes for easier measurements for sure. I tried some 555 variations with a H11D1 but I didn't get it to work like I hoped. In any case, this circuit is driven completely different than just a 555 with opto isolator.

D1 & D2 should be Hyperfast diodes.D2 could be an SCR triggered by a zener or something to allow the cap to build up to even higher voltage and the cap could be higher capacitance as well if you want a cap discharge circuit dumping the recovery back to the front battery like a Bedini system so it would be like an Ainslie-Bedini hybrid.

D3 & D4 should be suppression diodes that are bidirectional such as 1.5KE400CA for example. AND these are optional as long as D1, D2 and C1 are working fine and are in good shape. The circuit is set to run the load at 12volts.If you want to modify it for 24volts, double the value of R3 & R4. Q2 & Q4 is optional. If you don't want that, then just take the connection from the Q1 collector straight over to R6.

And of course put the current sensing resistor at the battery ground. Use as low of resistance as possible. I've been using 0.25 ohms because that is what Rosemary used. Peter gave me a 0.05 ohm resistor that I used originally but I'm not sure where it is at the moment but I will switch to that when I find it.

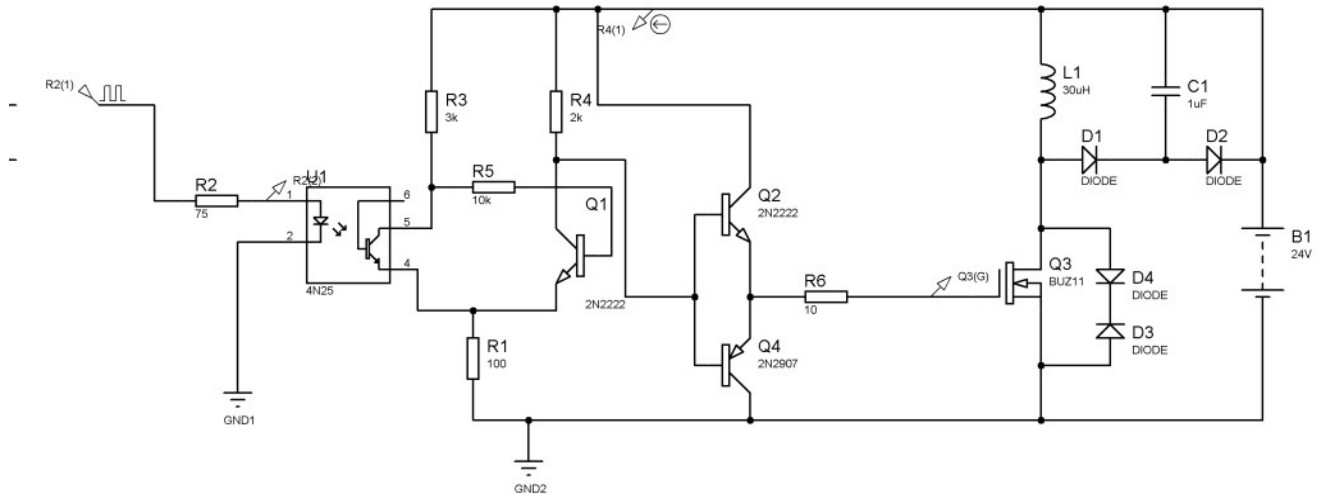
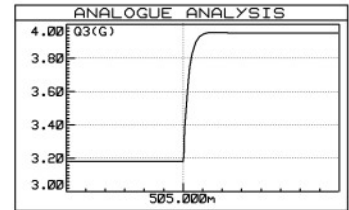
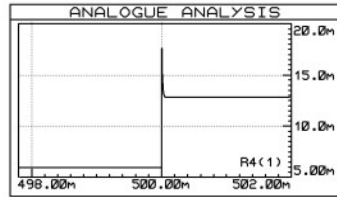

### Closing the Loop by Aaron

That was one of my original thoughts about an efficient heating circuit. Use heat to make steam to turn a turbine and turn electric generator or use heat on a thermo coupler to make electricity and put that back to the front. But, both thermo couplers and steam turbine to electric - aren't they both 20% or less efficient? I'm not sure what a Sterling Engine's efficiency is, probably low too. Could turn a little generator that charges a cap and feeds back to the battery or at least input. I'm sure other ideas about this will surface here.

With 17-20 cop possibility, I'd be happy with just taking all the heat as heat to heat water in a hot water tank for example. The cost to make hot water would then be almost nothing and I would be happy to pay almost nothing Regular heating elements are high efficiency even at 3000 watts..efficient as far as the current turning directly into heat but heat pump hot water heater retro-fits can make the same heat for only 400-600 watts so that is several COP right there and that can be had now.

Anyway, I'm looking forward to EXACT replication attempts first just to validate the efficiency. The quantum article even gives turns, spacing, etc... of the 10 ohm wire wound resistor, etc... Armagdn03 is the first to show on you tube that I know of that you can power a heating element (incandescent bulb) with purely reactive power.

### **Technical discussion regarding the Submitted "open source" paper to the IEEE -Open Source Evaluation of Power Transients Generated to Improve Performance Coefficient of Resistive Heating Systems**

From Harvey -Hi all - as most now know, I think, an open source paper has been prepared with Glen's arduous tests as a basis. Of course his tests have the original Ainslie experiment as its basis. And...of course...the original Ainslie experiment has Rosemary's Magnetic Model as it's basis.

As we understand it, the conservation of energy applies and only in rare circumstances like [Xnyoung Fu's](#) experiment, have the COE laws been officially challenged and even then he lost support due to the implications.

Rather than boldly state that an enormous field of potential energy exists that can be tapped like Paul did with his [Dirac Sea](#), we have taken a more conservative approach as it relates to that energy known to given be away in the binding of atoms to each other. The strength of these bonds, known as [Bond Strength](#) in chemistry, is related to the [Chemical Bond](#) of given materials. The [Bond Disassociation Energy](#) (BDE) is a real energy recognized in chemistry and is generally determined by a process of [Homolysis](#) where free radicals are produced. It takes a fair amount of energy to disassociate an atom from its bound state and allow it to express itself as a free radical because solid matter is in a neutral state at a low energy level. But as Rosemary has recently reminded me, the smallest possible neutral particle (or powder as she put it) of any material is the lowest energy state of that material. This means that when a free radical exists it has an inherent energy potential because it is looking to be joined up to reach its lowest energy state. When these free radicals are rejoined, either to each other or with oxygen or other compounds found in the atmosphere, they give up energy. Some of this energy comes from the external material provided by the atmosphere. It is this external energy which becomes usable in this arrangement.

In the paper, reference was made to an exploding wire that had too much current flowing through it and the energy that was released in that process as opposed to a gradual decay of material and the energy associated with it. The reality is, that more energy is demonstrated over the gradual decay because of the external energy that is made available to the system. While the exploding wire may produce a very dramatic effect, most of the energy demonstrated comes from the power source with only small

amounts added from the recombination of molecules whereas with the Ainslie Heater a fair amount of energy is believed to come from an external source. In the case of the wire, the recombination energy, where free radicals recombine with each other, will be equal or less than the energy required to separate the molecules in the first place. In the case of the Heater we expect a greater quantity of combination with external material which offers new energy to the equation.

Because energy is often converted between forms, we can view this in simplistic terms and simply state that the energy produced is electromagnetic. When the produced energy transaction occurs inside a changing magnetic field it can merge with that field and add to its magnitude. Then, when that changing field collapses back into the inductor from whence it came, it will be carrying a new energy with it. Interestingly, according to Rosemary's model and in agreement with the Superposition Theorem, the little extra we get is considered a separate current and this separate current seeks balance from its own source. Now, try to imagine this in real terms.

When the magnetic field collapses it has the energy from two sources. The first source is the 24V battery and the second source is that energy produced in the inductor's material when these free radicals recombine, or oxidize or what have you. Both energies are manifest in the amplitude of voltage present across the resistor-inductor. But while the one current is seeking its source, the 24V battery, the other current is simply seeking the other end of the resistor-inductor. This means that if we were able to view the current flow, in the inductor's windings themselves, it would be different than the current flow in the wire connecting that same inductor to the battery! Likewise, if the circuit roundabout has less resistance than the inductor, then a greater current would flow through that path than the source was providing. To clarify that statement a little bit better; if the CEMF pulse was allowed to complete its path to the B(-), say through another load of less resistance than the inductor (or if the inductor had a diode at its exit to prohibit reverse current) then that current would prove to be greater than the current provided by the battery itself. Furthermore, the battery lead between the battery and inductor would show a new current flowing back to the inductor that would represent exactly that current provided by the molecular binding.

Now the reason for the prior post was to draw attention to the cause of the extra energy and address the direction that will inevitably follow.

One of the things Rosemary has consistently stated, and this is quite counter intuitive, is that the mass of the material is important to the amount of energy that can be generated. When working with resistive wires and we are trying to get more heat we classically look for the smaller wire because it has the higher resistance. This may be the primary reason why classically this effect has been overlooked.

To provide a more optimum effect then, materials research will need to be done along the lines of finding those materials that produce the most resistance and inductance while affording a high current flow. Additionally, the material of choice will have a characteristic of producing free radicals during thermomagnetic interactions which can be readily oxidized. This is where the greater mass comes in, because the more molecules or atoms that can be released from the mass, the greater the energy generated during their recombination with external elements.

It would be an interesting exercise to determine what the known energy is for the oxidation of the materials in our resistors when they are in a radical form. Also, what the energy differentials would be for two radicals of opposite ionization to combine in comparison to the BDE to remove them from the anchor atom in the lattice. Even that may produce a gain that could be applied in a vacuum environment.

These are solid fuel approaches, but we cannot overlook the possible advantages of liquid fuels or gases, even plasmas that could produce this form of fission at much higher levels using this same magnetic shock approach. So, materials research will play an important role in the next steps.

### **Theories by Chad**

Consider the Thompson effect: Back in 1851 William Thompson took a steel wire and heated a junction of the wire. When he ran current he found that the temperature difference created a voltage potential. He also found that as the voltage increased from cold to hot there was heating but as voltage decreased from hot to cold there was ADDITIONAL COOLING!

[http://www.daviddarling.info/encyclopedia/T/Thomson\\_effect.html](http://www.daviddarling.info/encyclopedia/T/Thomson_effect.html)

Yes, here we have an example of electrons causing a cooling effect and shedding spin (aka. vector curl) in a process that sounds similar to the cooling effect in OU devices.

There is also the Peltier effect: [http://en.wikipedia.org/wiki/Thermoelectric\\_effect](http://en.wikipedia.org/wiki/Thermoelectric_effect)

This happens when we have a junction between two dissimilar metals. Between the copper and nichrome wire we have 2 metals with different electron densities creating a P-N junction. As current moves through the junction of the wires the electrons carry entropy thus causing heat and cold to move in opposite directions.

Two concepts that tie this together:

Fermi energy: The number of free electrons in a metal at absolute zero temperature.  
[http://en.wikipedia.org/wiki/Fermi\\_energy](http://en.wikipedia.org/wiki/Fermi_energy)

Fermi Level: The distribution of free electrons according to Dirac statistics as temperature increases from absolute zero. [http://en.wikipedia.org/wiki/Fermi\\_level](http://en.wikipedia.org/wiki/Fermi_level)

The Fermi level is directly tied to voltage potential or level of localized spin. The key here is to allow the electrons to acquire and release spin across the junction in a way that is not symmetrical. The Dotto Ring did the same thing and created a high-spin magnetic field that has the same effect as high-spin transition metals (ORMUS).

### **Understanding electrical embodiments of oscillation by Armagdn03**

[Transient Energy Enhances Energy Co-Efficients by R. A. Ainslie and B. C. Buckley](#)

#### **A MAGNETIC FIELD MODEL**

<http://rosemaryainslie.blogspot.com/2008/09/test.html>

[Rosemary Ainslie -EIT paper](#)

<http://www.scribd.com/doc/23459123/Magnetic-Field-Model>

[http://www.feelthevibe.com/free\\_ener...ent\\_energy.pdf](http://www.feelthevibe.com/free_ener...ent_energy.pdf)

[YouTube - tortuga0303's Channel](#)

[Self-Inductance and Inductive Reactance](#)

[Hawkins electrical guide - Google Book Search](#)

Energetic forum thread- [Rosemary Ainslie | A Magnetic Field Model](#)

#### **Related Patent information**

Rosemary Ainslie - [Patent](#)

[Electro Information Technology \(EIT\) Conference IEEE Africon 2009 Paper](#)

[Patent Cooperation Treaty \(PCT\) Published Application WO 03\\_007657 A2 \(2003\)](#)

[Quantum Article - October 2002](#)

[1999 European Patent Application EP0932248A1](#)

[Patent Cooperation Treaty \(PCT\) Published Application WO 99\\_38247 \(1999\)](#)

[Energy conversion system - Google Patents](#)

check out the links to this patent's many interesting citations.

[Electrical invertors apparatus - Google Patents](#)



[Energy conversion system - Google Patents](#) - The Tesla Turbine of my dreams again!

[Coaxial pseudo spark discharge switch - Google Patents](#)

### **Other Heaters to compare with**

Here is a water heater already available that boasts exactly that, 1/4th the power consumption of a standard water heater:

[household heat pump water heater RF-51 \(320L\) heat pump CN;GUA products](#)

Here is a demonstration of an induction heater boiling water:

[YouTube - induction heating \(water boiling\)](#)

Next is an off the shelf induction water heater. These systems do not store hot water, they heat it instantly on demand. That way you do not need to keep using power to keep the water hot all day and all night:

[Induction Water Heater\(\) - Oasis Provider Co., Ltd. in ACE Suppliers B2B Marketplace](#)

Here is one just like it:

[Induction Water Geyser](#)

And here is a paper written on the subject from some persons in South Africa:

<http://active.cput.ac.za/energy/web/...Manuel%20G.pdf>

## **Supplies**

IRFPG50-- Page 14 has information on the IRFPG50

[http://www.rose-hulman.edu/~herniter...ata\\_Sheets.pdf](http://www.rose-hulman.edu/~herniter...ata_Sheets.pdf)

## **Technical support**

<http://www.energeticforum.com/renewable-energy/4314-cop-17-heater-rosemary-ainslie.html>

## **Credits**

The open source energy community

If you are able to contribute to this document in ANY way, IE- replication details, faculty info and or additional data please contact the nonprofit organization.

<http://www.panacea-bocaf.org>

<http://www.panaceauniversity.org>