

# ILLUSTRATED Maths DICTIONARY

4<sup>TH</sup> EDITION



PEARSON  
Education  
Australia

JUDITH DE KLERK



ILLUSTRATED  
**Maths**  
DICTIONARY

4<sup>TH</sup> EDITION

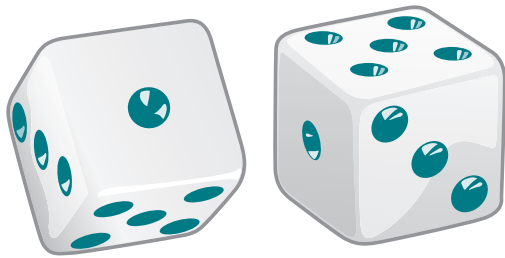

JUDITH DE KLERK



Sydney, Melbourne, Brisbane, Perth  
and associated companies around the world.

Judith de Klerk passed away during the production of this fourth edition of her dictionary. She was committed to updating the dictionary and ensuring it was perfect although she was quite ill. She was assisted in all her endeavours by her husband, Louis de Klerk, who continued Judith's work.

Pearson Education Australia  
A division of Pearson Australia Group Pty Ltd  
Level 9, 5 Queens Road  
Melbourne 3004 Australia  
[www.pearsoned.com.au/schools](http://www.pearsoned.com.au/schools)

Offices in Sydney, Brisbane and Perth, and associated companies throughout the world.

Copyright © Pearson Education Australia  
(a division of Pearson Australia Group Pty Ltd) 2007  
First published 1983  
Reprinted 1984, 1985, 1986, 1988, 1989 (Twice)  
Second edition 1990  
Third edition 1999  
Fourth edition 2007

All rights reserved. Except under the conditions described in the Copyright Act 1968 of Australia and subsequent amendments, no part of this publication may be reproduced, stored in a retrieval system or transmitted in any form or by any means, electronic, mechanical, photocopying, recording or otherwise, without the prior permission of the copyright owner.

Designed by Ben Galpin  
Typeset by Miriam Steenhauer & Eugenio Fazio  
Cover design by Ben Galpin  
Cover illustrations by Ben Galpin & Boris Silvestri  
Edited by Sally Green  
Prepress work by The Type Factory  
Produced by Pearson Education Australia  
Printed in Malaysia

National Library of Australia  
Cataloguing-in-Publication data  
De Klerk, Judith.  
Illustrated maths dictionary for Australian schools.

4<sup>th</sup> ed.  
ISBN 9780 7339 8661 1

Every effort has been made to trace and acknowledge copyright. However, should any infringement have occurred, the publishers tender their apologies and invite copyright owners to contact them.

The  
publisher's  
policy is to use  
**paper manufactured  
from sustainable forests**



---

# Contents

---

<b>A-Z</b>	<b>1</b>
<b>Useful information</b>	<b>146</b>
Units of measurement	146
A list of symbols	147
Roman numerals	148
Parts of a circle	148
Metric relationships	149
Formulae	150
More formulae	151
Large numbers	152
Letters used in mathematics	152
Decimal system prefixes	153
Numerical prefixes	153
Other prefixes	154
The multiplication square	154
Greek alphabet	155
Conversion tables:	
metric and imperial	156
Computing terms	158

---

# Introduction

The language of mathematics often confuses children and it is sometimes difficult for teachers to explain the meaning of mathematical terms simply but accurately.

The fourth edition of this Illustrated Maths Dictionary offers an up-to-date dictionary of maths terms with the addition of a section explaining commonly used computer terms that have mathematical connotations. The definitions are written in simple language that children can understand, yet are clear, precise and concise. The terms are supported by hundreds of examples and illustrations.

This is essentially a dictionary for students, but I hope that teachers, parents and tertiary students will also find it helpful.

Judith de Klerk

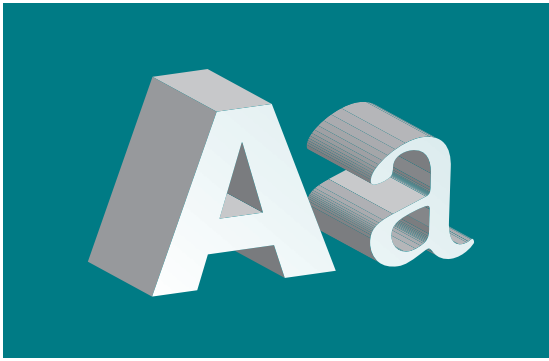
**a**

(i) In formulas, the letter A stands for area.

*Example*

Area of a triangle

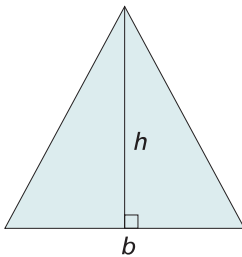

$$A = \frac{b \times h}{2}$$

(ii) A, and other letters, are used to name points, lines, angles and corners (vertices) of polygons and solids.

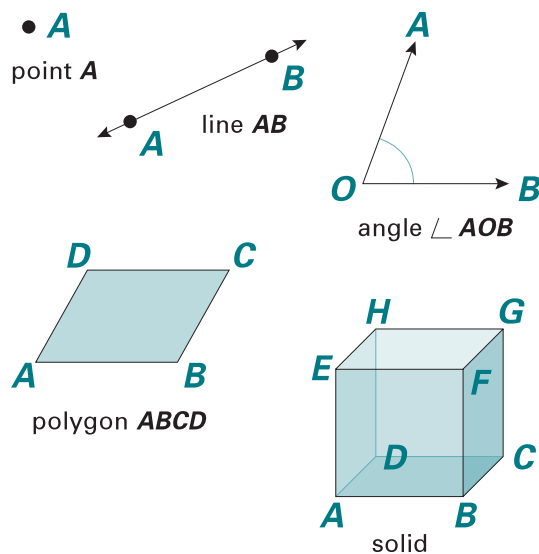
*Examples*

See angle name, area, formula, line, point, vertex

**abacus**

Usually a board with spikes or a frame with wires on which discs, beads or counters are placed. Used for counting and calculating.

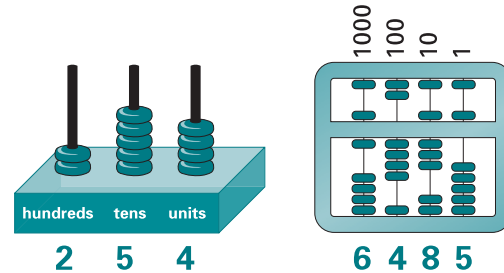
*Examples***abbreviation**

A shortened form of writing words and phrases.

When writing shortened forms of words, we usually put full stops after the letters.

*Example*

Victoria: Vic.

Note: cm (centimetre) is a symbol. We do not write full stops after symbols.

*Examples*

m cm mm kg mL m<sup>2</sup> cm<sup>3</sup>

See symbol

**abscissa**

The horizontal coordinate, or  $x$ -coordinate, of a point in a two-dimensional system of Cartesian coordinates is sometimes called the abscissa.

See axis, coordinates, ordinate



## accurate

Exact, correct, right, without error.

Note: Measurements are not exact. We usually measure to the nearest unit, therefore our answers are only approximate. For example, if we say something is 30 cm long, we mean nearer to 30 cm than to either 31 cm or 29 cm.

See approximately

## acute

Sharp. Sharply pointed.

(i) Acute angle.

A sharply pointed angle with size less than a right angle ( $< 90^\circ$ ).

Examples

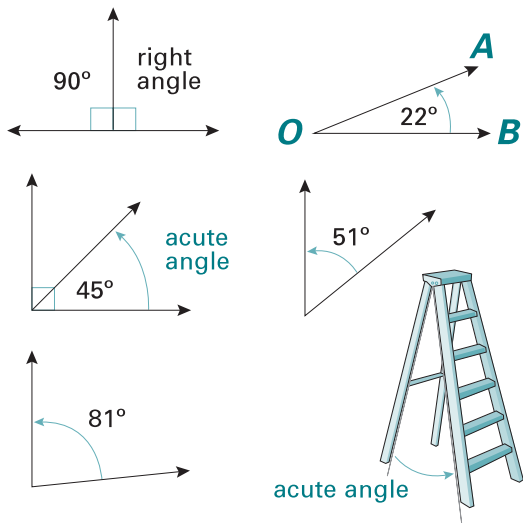

See angle, right angle

(ii) Acute triangle.

A triangle with all three inside angles being acute.

Example

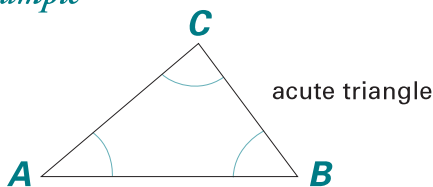

See equilateral triangle, obtuse triangle, right-angled triangle, scalene triangle

## AD

(Anno Domini)

Meaning: In the year of our Lord. After the birth of Christ.

Example

The eruption of Mount Vesuvius in AD 79 destroyed Pompeii.

See BC, CE

## add

Join two or more numbers or quantities together.

Example

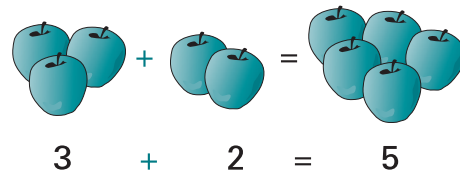

The apples were added together.

See addition, quantity

## addend

Any number which is to be added.

Example

$$2 + 6 = 8$$

↑     ↑     ↑  
addend addend sum

In  $2 + 6 = 8$ , 2 and 6 are addends, 8 is the sum.



## addition

(symbol: +)

- (i) Joining the values of two or more numbers together.

$$3 + 7 = 10$$

- (ii) On the number line.

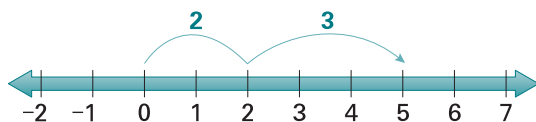

$$2 + 3 = 5$$

- (iii) Addition of fractions.

$$\frac{1}{4} + \frac{3}{5} = \frac{5+12}{20} = \frac{17}{20}$$

- (iv) Addition of integers.

$$+5 + -7 = -2$$

- (v) Addition of algebraic terms.

$$2a + 3b + 5a = 7a + 3b$$

See algebraic expression, fraction, integers, number line

## addition property of zero

When zero is added to any number, the sum is the same as the number.

*Examples*

$$4 + 0 = 4$$

$$0 + 12 = 12$$

See sum, zero

## additive inverse

When we add a number and its inverse, the answer is zero.

*Example*

$$8 + -8 = 0$$

↑     ↑

number    inverse

See inverse, zero

## adjacent

Positioned next to each other, having a common point or side.

*Example*

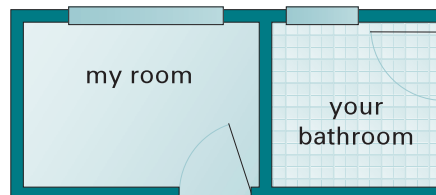

My room is adjacent to your bathroom.

- (i) Adjacent sides.

*Example*

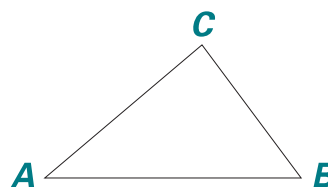

In this triangle, side  $AB$  is adjacent to side  $AC$  because they have a common vertex  $A$ .

- (ii) Adjacent angles.

Two angles positioned in the same plane that have a common side and a common vertex.

*Example*

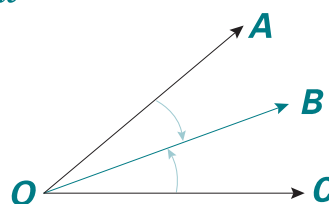

$\angle AOB$  is adjacent to  $\angle BOC$  because they have a common ray  $\vec{OB}$ .

See plane, vertex

## algebra

Part of mathematics that studies number systems and number properties.

See algebraic expression, coefficient, numeral, pronumeral, symbol, variable





## algebraic expression

In algebra we use numerals, symbols and letters called variables or pronumerals, and combinations of both. They stand for the unknown values.

### Examples

$$\text{flower} + \text{flower} = 2 \text{ flowers}$$

$$5 - x$$

$$a + b + c$$

$$x^2 - 2xy + y$$

See coefficient, numeral, pronumeral, symbol, value, variable

## algorithm

(algorism)

A rule for solving a problem in a certain number of steps. Every step is clearly described.

### Example

Use blocks to find how many  $3 \times 4$  is.

**Step 1** Lay down one lot of four blocks.



**Step 2** Put down the second and third lots of four.

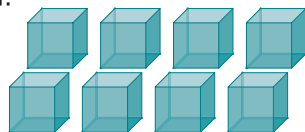

**Step 3** Exchange 10 units for one ten (long).

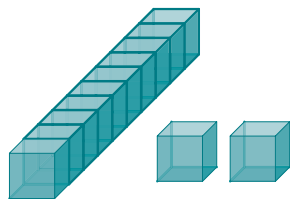

**Step 4** Write down your answer.

$$3 \times 4 = 12$$

See multibase arithmetic blocks (MAB)

## align

Lay, place in a straight line.

### Example

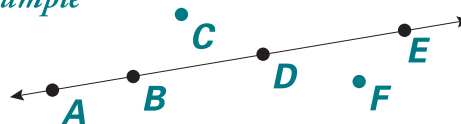

Points *A*, *B*, *D* and *E* are aligned; points *C* and *F* are not.

See line

## alternate angles

See parallel lines

## altitude

Height. How high something is above the surface of the Earth, sea level or horizon. Altitude is the length of perpendicular height from base to vertex.

### Example

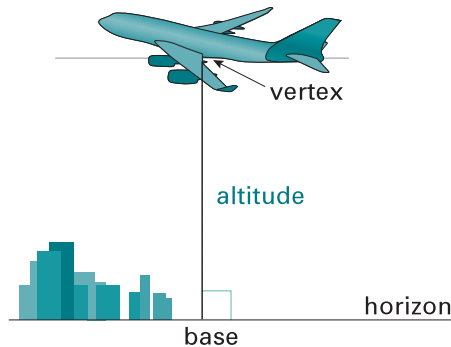

The altitude of this aeroplane is 9000 metres.

See height, perpendicular, surface

## a.m.

(ante meridiem)

The time from immediately after midnight until immediately before midday. The term a.m. is used only with 12-hour time.

**Example**

It is morning.

The time is five past five.

It is 5.05 a.m.

See p.m.



**amount**

An amount of something means how much of that thing.

**Example**

The amount of money in my pocket.

**analogue clock**

A clock or a watch that has numerals 1–12 on its face, and two hands pointing at them to show the time.

**Example**

This clock shows twenty-five minutes past nine in the morning.

It is 9.25 a.m.

See a.m., digital clock, p.m.



Angle is the inclination of two lines to each other.

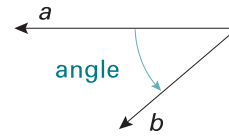

Angles are measured in degrees ( $^{\circ}$ ), minutes ( $'$ ) and seconds ( $''$ ).

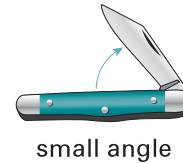
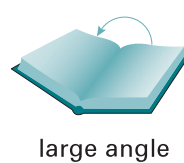
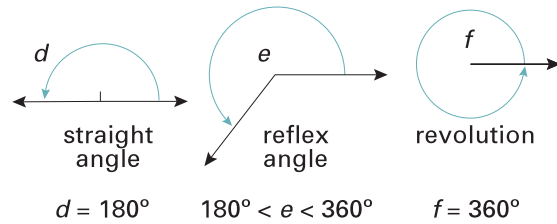
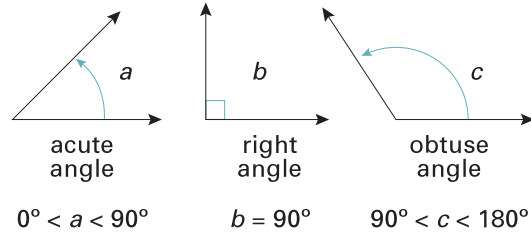

See acute, degree, obtuse angle, parallel lines, ray, reflex angle, revolution, right angle, straight angle

**angle**

The space between two straight lines with a common end point (vertex).

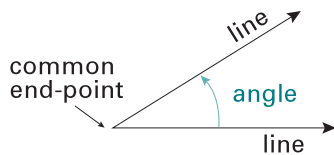

An angle is the amount of turn of a ray about a fixed point.

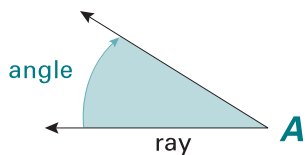

**angle name**

Angles are given names by marking them with letters.

**Example**

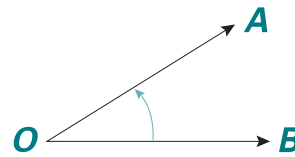

The name of this angle is  $\angle AOB$ . The letter O in the middle ( $\angle AOB$ ) indicates the common end point.



## angle of depression

(of an object)

An angle formed between the horizontal line and the line of sight to an object below.

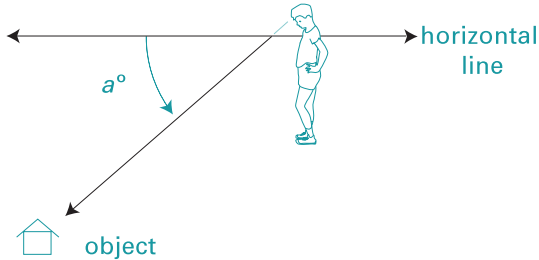

The angle of depression is  $a^\circ$ .

See angle of elevation

## angle of elevation

An angle formed between the horizontal line and the line of sight to an object above.

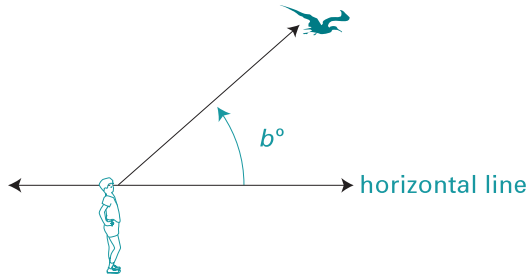

The angle of elevation is  $b^\circ$ .

See angle of depression

## angle sum

The total amount of degrees in any polygon.

(i) Angle sum of a triangle is  $180^\circ$ .

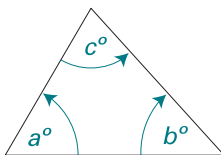

$$a^\circ + b^\circ + c^\circ = 180^\circ$$

(ii) Angle sum of a quadrilateral is  $360^\circ$ .

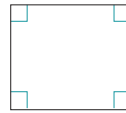

$$4 \times 90^\circ = 360^\circ$$

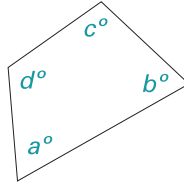

$$a^\circ + b^\circ + c^\circ + d^\circ = 360^\circ$$

(iii) Angle sum of any polygon may be found:

$$\begin{aligned} &\text{number of vertices} \times 180^\circ - 360^\circ \text{ or} \\ &(\text{number of vertices} - 2) \times 180^\circ \end{aligned}$$

### Examples

triangle  $(3 \times 180^\circ) - 360^\circ = 180^\circ$  or  $(3 - 2) \times 180^\circ = 180^\circ$

pentagon  $(5 - 2) \times 180^\circ = 540^\circ$

hexagon  $(6 \times 180^\circ) - 360^\circ = 720^\circ$

## annual

(i) Happening only once a year.

### Example

Annual flower show.

(ii) Recurring yearly.

### Example

Annual rate of interest is 6.5%.

See per annum, per cent

## annulus

The area between two concentric circles.

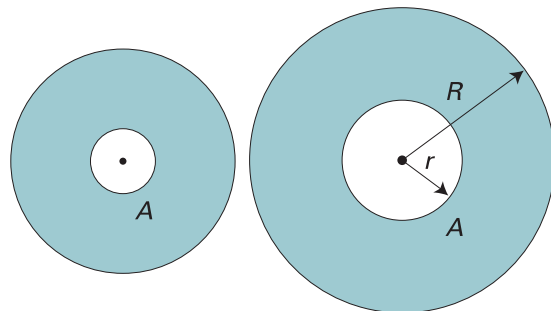

$$A = \pi (R^2 - r^2)$$

See area, circle, concentric circles

## anticlockwise

The direction opposite to that in which the hands of a clock travel.

### Example



This clock is fifteen minutes fast. The hands must be moved back to show the exact time.



The hands have been moved in an anticlockwise direction.

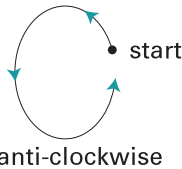

anti-clockwise

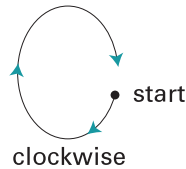

clockwise

### Example

Screws and bottle tops are loosened in an anticlockwise direction.

See clockwise

## apex

The highest point where two or more lines meet to form a corner of a figure or solid. The apex is the furthest vertical distance from the base.

### Examples

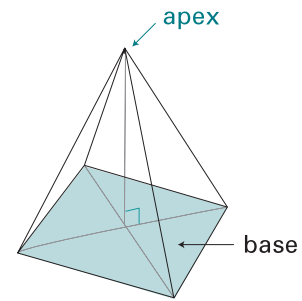
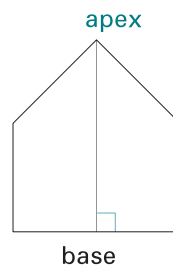

See base, pyramid, vertex

## approximately

(symbols:  $\approx$   $\doteq$   $\simeq$ )

Nearly, not exactly, but almost. The symbols  $\approx$  or  $\doteq$  or  $\simeq$  may be used for 'is approximately equal to'.

### Example

The expressions

$$0.97 \approx 1 \quad 0.97 \doteq 1 \quad 0.97 \simeq 1$$

all mean '0.97 is approximately equal to 1'.

See accurate, rounding

## approximation

(symbols:  $\approx$   $\doteq$   $\simeq$ )

A result which is nearly, not exactly, but almost accurate. One method of approximation is calculating with rounded figures.

### Examples

(i)  $798 \times 2.1 \approx 800 \times 2 \approx 1600$

(ii) The value of 3.14 for  $\pi$  is only an approximation.

See accurate, approximately, rounding

## Arabic numerals

1, 2, 3, 4, 5 ... Now in common use in all western countries.

See Hindu–Arabic





## arbitrary unit

Something to help us measure.

### Examples

Handspan, pace, counters, tiles, cubes, squares and bottle tops are arbitrary units.

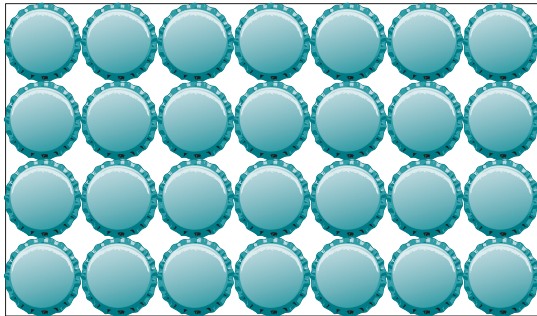

The area of this rectangle has been measured in bottle tops. The area is twenty-eight bottle tops.

See handspan

## arc

A part of any curve, but most often used to mean a part of a circle.

### Example

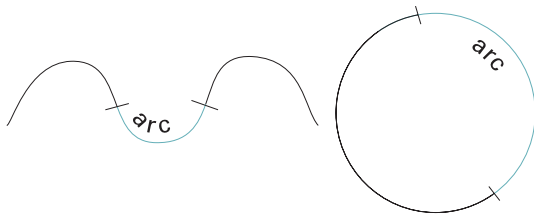

See circle, curve

## are

Unit of area in the metric system. It is the area of a square with sides measuring 10 metres.

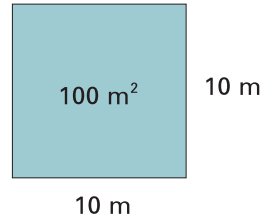

$$100 \text{ m}^2 = 1 \text{ are}$$

$$100 \text{ are} = 1 \text{ ha}$$

See area, hectare

## area

The amount of surface or the size of a surface. Area is measured in square units.

Units of area are:

square centimetre	cm <sup>2</sup>
square metre	m <sup>2</sup>
hectare	ha
square kilometre	km <sup>2</sup>

### Example

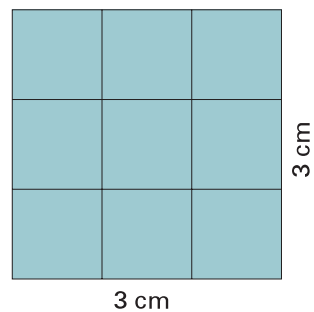

The area of this shape is  
base × height  
 $3 \text{ cm} \times 3 \text{ cm} = 9 \text{ cm}^2$

See conservation of area, formula, surface, unit of measurement

## arithmetic

The part of mathematics concerned with the study of numbers. Arithmetic is used for computations with whole numbers, fractions and decimals. The computations include addition, subtraction, multiplication and division. Arithmetic is also used for measurement, solving word problems and working with money.

*See* computation

## arithmetic mean

*See* average, mean

## arithmetic progression

*See* progression

## arm of an angle

One of the lines which make an angle.

*Example*

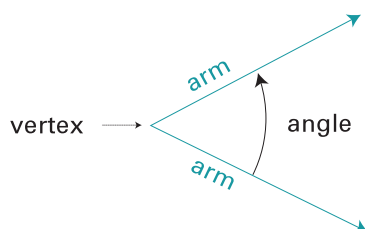

*See* angle, vertex

## array

Arrangement of objects or numbers, in columns or rows.

*Examples*

	3	7	12
	5	8	10
	4	16	32
			

An array of objects in rows and columns

These numbers form an array.

## arrow

Used to indicate direction.

*Example*

Weather vane



## arrow diagram

A diagram using arrows to show a relation (or connection) between one thing and another.

*Examples*

(i) Relation in one set of numbers

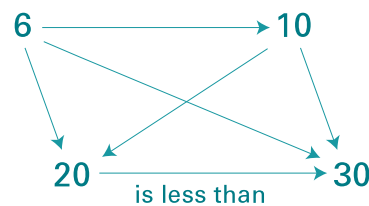

(ii) Relation between two sets

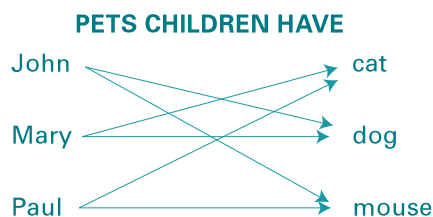

*See* many-to-one correspondence, mapping, one-to-one correspondence, relation, set







## attribute

A characteristic of an object.

### Examples

Shape, size, colour.

- (i) Attributes of shape:  
round, square, hexagonal ...

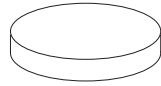

round and thin

- (ii) Attributes of size:  
thick, thin, small, big ...

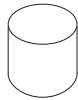

round and thick

- (iii) Attributes of colour:  
black, red, yellow ...



square and black

Other classifications different from the examples above are clearly possible.

### ATTRIBUTES OF CHILDREN

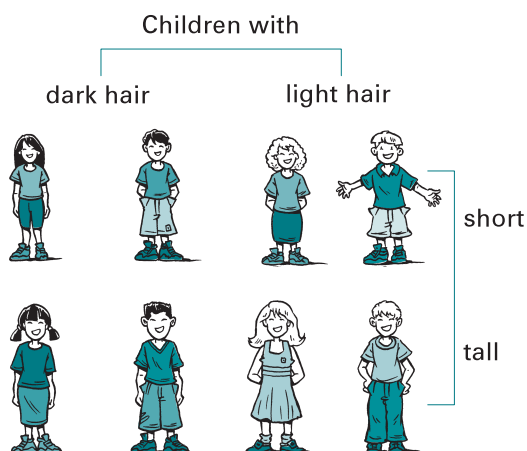

See classify, property

## average

The average of a collection of numbers or scores is one score which represents the whole collection. It is found by adding all of the scores and dividing the answer (sum) by the number of scores.

### Example

Find the average of scores 2, 5, 4, 6 and 3.

$$\begin{aligned} \text{Average} &= \frac{\text{sum of scores}}{\text{number of scores}} \\ &= \frac{2 + 5 + 4 + 6 + 3}{5} \\ &= \frac{20}{5} \end{aligned}$$

$$\text{Average} = 4$$

This is also called the mean or arithmetic mean.

See mean, score, sum





## axis

(Plural: axes)

- (i) The lines which form the framework for a graph. The horizontal axis is called  $x$ -axis, the vertical axis is called  $y$ -axis. Both axes are marked with equally spaced scales. The point where the axes intersect is called the origin (O).

### Example

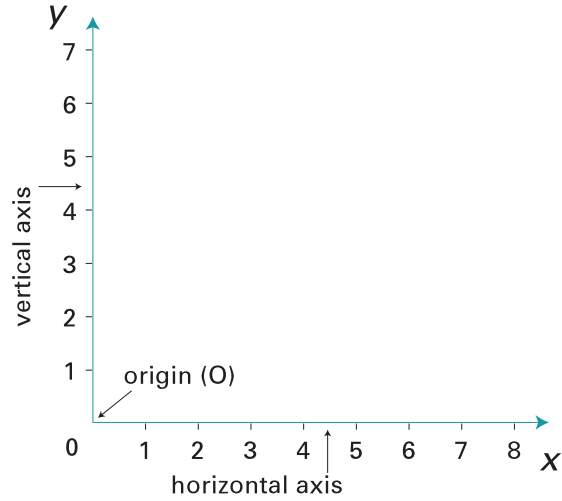

Axes are sometimes called:

**$x$ -axis = abscissa**

**$y$ -axis = ordinate**

- (ii) A main line going through the centre of a figure or solid, also called a line of symmetry, or an axis of symmetry.

### Examples

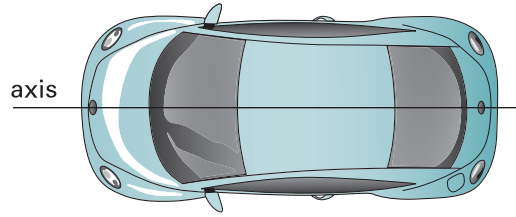
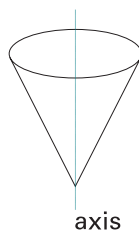
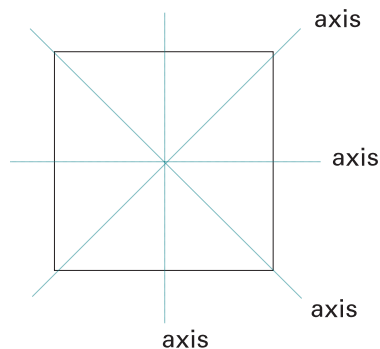

See coordinates, graph, horizontal line, intersection, line of symmetry, origin, vertical

## axis of symmetry

See axis, line of symmetry

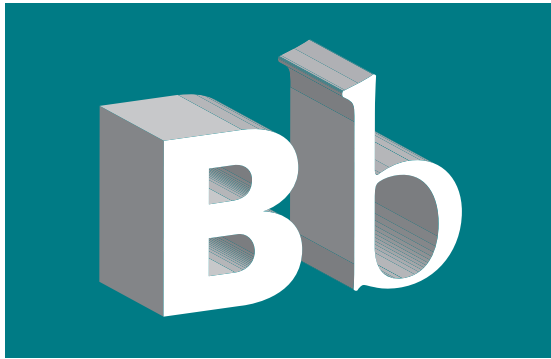

## bar graph

A graph which uses horizontal or vertical bars to represent various kinds of information. A bar graph with vertical bars or columns is also called a column graph.



### Examples

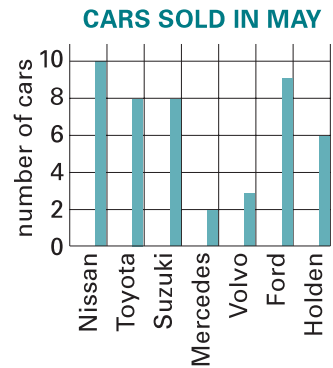
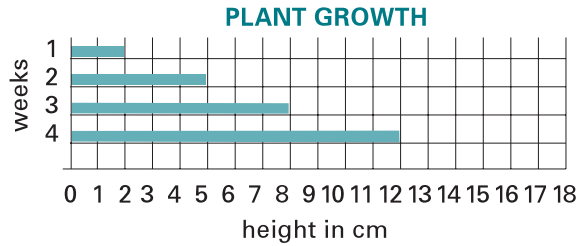

See column graph, graph, pie graph, pictograph

## balance

(i) An equal distribution.

### Example

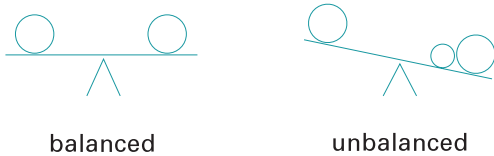

(ii) Balance scales is a name given to some kinds of scales used for weighing things.

### Example



a spring balance

See beam balance

(iii) The amount of money in a bank account.

### Example

Date	Description	Credit	Debit	Balance
2006				
02 Feb	Pay	350		
05 Feb	ATM withdrawal		200	150
10 Feb	Rent		50	100
16 Feb	Pay	350		450
21 Feb	Rates		295	155

## base

(i) The face on which a shape or a solid stands.

### Examples

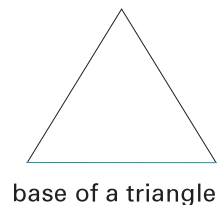
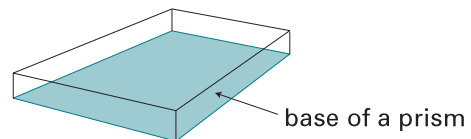

▣ base continued...



(ii) The number on which a place value system of numeration is constructed.

*Example*

hundreds	tens	units	tenths

100x bigger (from units to hundreds)  
 10x bigger (from units to tens)  
 10x smaller (from units to tenths)

The Hindu–Arabic system is a base 10 system.

(iii) A number, symbol or a variable used with index to show an index notation.

*Examples*

In index notation, the base is the number we read first.

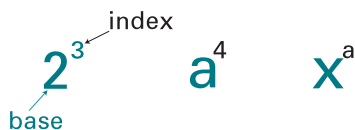

In  $2^3$ , read ‘two cubed’, 2 is called the base.

*See decimal place-value system, exponent, index, index notation, power of a number*

**base line**

(i) The horizontal axis of a graph.

*Example*

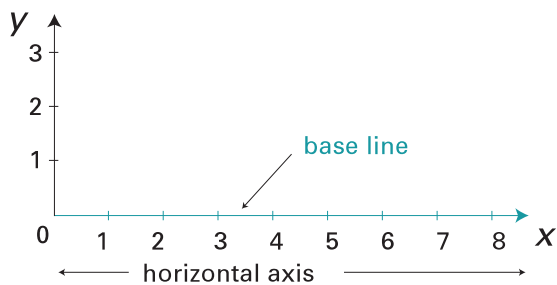

(ii) A base from which the heights of objects may be compared.

*Example*

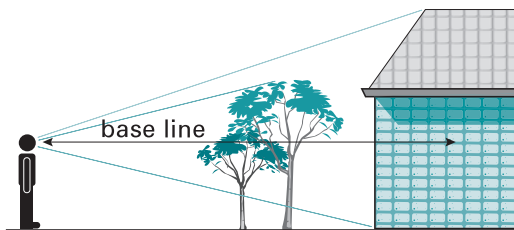

*See axis, horizontal line*

**base ten system**

*See decimal place-value system, decimal system, index, index notation, multibase arithmetic blocks, power of a number*

**basic facts**

Operations performed with one-digit numbers 0, 1, 2, 3, 4, 5, 6, 7, 8 and 9.

*Examples*

Addition

$$0 + 0 = 0 \quad 0 + 1 = 1$$

$$1 + 1 = 2 \quad 9 + 9 = 18$$

Subtraction corresponds with addition.

Multiplication

$$0 \times 0 = 0 \quad 0 \times 1 = 0$$

$$1 \times 1 = 1 \quad 9 \times 9 = 81$$

Division corresponds with multiplication.

(Note: It is not possible to divide by zero!)

*See digit, operation, zero*

## battleships

A game in which two players have identical grids on which they mark 'battleships' in random positions. Each has to guess the position of the opponent's battleships by naming either:

- (i) the cells on the grid

### Example

	A	B	C	D	E
1					
2					
3				▲	
4					
5					

(D,3)

or

- (ii) points of intersection of lines to pinpoint their location.

### Example

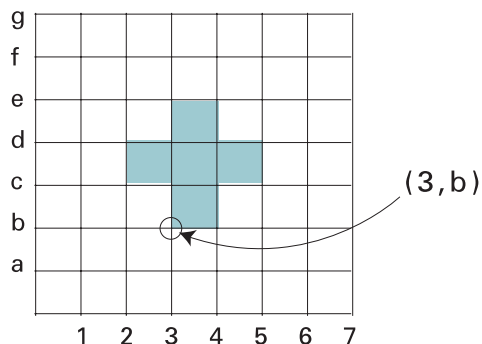

(Note: Ordered pairs are used to locate the cells or the points.)

See [coordinates](#), [grid](#), [ordered pair](#)

## BC

(Before Christ)

The years before Christ was born.

### Example

Egyptian Pharaoh Tutankhamen ruled in 14th-century BC.

See [BCE](#), [AD](#)

## BCE

(Before the Common Era)

Indicates the same period as BC.

BCE can be used in place of BC.

See [BC](#), [AD](#)



## beam balance

Any balance where a beam is used.

### Examples

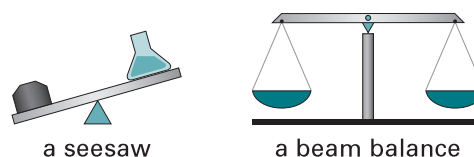

A beam balance is used to measure the mass of an object by balancing it with an object whose mass is known.

See [balance](#), [mass](#)

## bearing

A horizontal angle measured from  $0^\circ$  to  $90^\circ$  between a north or south direction and the direction of the object.

True bearings are measured to the true north direction, magnetic bearings to the magnetic north (or south).

### Example

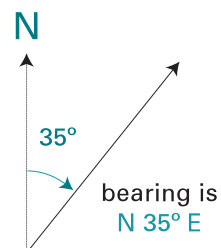

See [compass](#), [direction](#)

**bi**



A prefix which stands in front of words and means two or twice.

*Examples*



bicycle

bifocals

See binomial, bisect, bisector

**bicentenary**

200th anniversary.

*Example*

1970 marked the bicentenary of Captain Cook's landing at Botany Bay.

**billion**

In most English-speaking countries, including Australia, a billion means 1000 millions.

$$1\ 000\ 000\ 000 \text{ or } 10^9$$

Note: In many European countries a billion means a million millions ( $10^{12}$ ).

**binary**

A base-2 number system that uses only 0 and 1 to represent numbers. It is the smallest number system used to represent information. All numbers can be represented in a binary system.

*Example*

Binary (Base-2) system

Place value	$a^7$	$a^6$	$a^5$	$a^4$	$a^3$	$a^2$	$a^1$	$a^0$	
Binary	$2^7$	$2^6$	$2^5$	$2^4$	$2^3$	$2^2$	$2^1$	$2^0$	
Value	128	64	32	16	8	4	2	1	Number
									0 0
								0 1	1
							1	0	2
						0	1	1	3
					0	1	0	0	4
				0	1	0	1	0	10
			0	1	1	1	1	1	15
		0	1	1	0	0	0	0	25
0	1	0	0	0	1	1	0	0	140

**binomial**

In algebra, an expression consisting of two terms joined by + or -. The terms are called monomials.

*Examples*

$$2 + a \quad 3a - b \quad 2x^2 + y^2$$

See algebra

**bisect**

To cut or divide into two equal parts.

*Example*

This angle has been bisected.

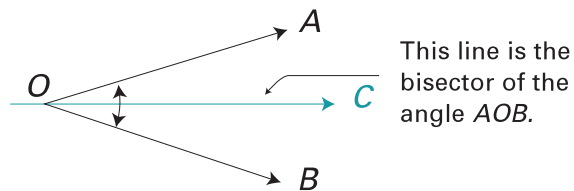

This line is the bisector of the angle AOB.

$$\angle AOC = \angle COB$$

## bisector

A straight line which divides an angle, or an interval, into two equal parts.

### Examples

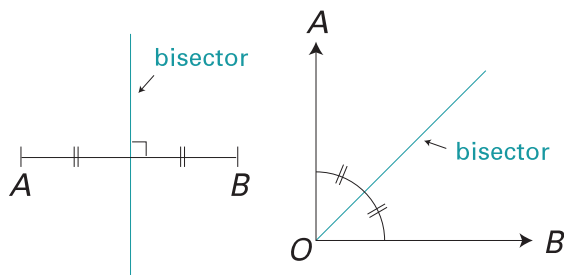

See bisect, interval, midpoint

## boundary

A line around the edge of a region.

### Examples

- (i) The boundary around a soccer field

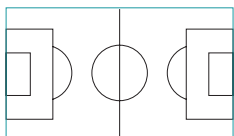

- (ii) The boundary of Queensland

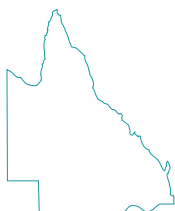

- (iii) The boundary of a hexagon is its perimeter.

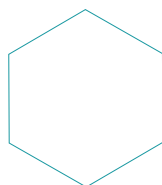

See perimeter, region

## braces

- (i) Braces are used for grouping numbers together.

### Example

$$\begin{aligned} \{ & \{ 3 + [12 - 3(2 + 1)] \times 2 \} \\ \text{braces} & = \{ 3 + [12 - 9] \times 2 \} \\ & = 3 + 6 \\ & = 9 \end{aligned}$$

- (ii) The sign  $\{ \}$  is used to stand for the word 'set'. The elements of the set are written inside these 'curly brackets'.

### Example

The set of counting numbers

$\{1, 2, 3, 4, 5, 6, 7, \dots\}$

See brackets, order of operations, parentheses

## brackets

The signs  $( ) [ ] \{ \}$  are used for grouping things or numbers together.

$( )$	$[ ]$	$\{ \}$
ordinary brackets (parentheses)	square brackets	braces

Brackets are used to indicate the order of operations.

### Example

$$\begin{aligned} & 5 \{ 2[4(3 + 10) - (35 \div 5) - 8] \} \\ & = 5 \{ 2[(4 \times 13) - 7 - 8] \} \quad \text{1 remove ordinary brackets} \\ & = 5 \{ 2[52 - 15] \} \quad \text{2 remove square brackets} \\ & = 5 \{ 2 \times 37 \} \quad \text{3 remove braces} \\ & = 5 \times 74 = 370 \end{aligned}$$

See braces, order of operations, parentheses



---

## breadth



Measurement from side to side, also called width.

### *Example*

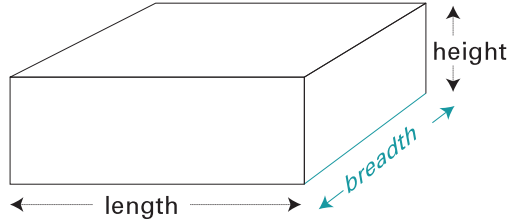

See height, length, width

---

## budget

A plan for using money.

### *Example*

Jessica earns \$560 a fortnight. Her budget is:

Rent and food	\$340
Bus fares	\$45
Clothes	\$50
Entertainment	\$60
Savings	\$65
<hr/> Total	<hr/> \$560





## C

- (i) C is a symbol for Celsius temperature scale.
- 0 °C      water freezes
- 100 °C      water boils
- (ii) A symbol for circumference in formulas.

### Examples

$$C = \pi d$$

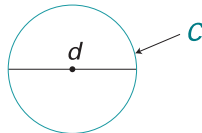

or  $C = 2\pi r$

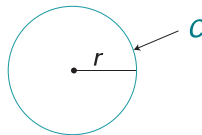

- (iii) In Roman numerals, C stands for one hundred.

### Example

$$CCCXXII = 322$$

## calculate

Work out the answer. Using mathematical procedures to determine a number, quantity or expression.

## calculator

Calculating aid. Calculators are electronic. They are battery or solar powered.



## calendar

A calendar represents the way in which a year is broken up into months, weeks and days.

### Example

2007						
JANUARY						
S	M	T	W	T	F	S
	1	2	3	4	5	6
7	8	9	10	11	12	13
14	15	16	17	18	19	20
21	22	23	24	25	26	27
28	29	30	31			
FEBRUARY						
S	M	T	W	T	F	S
				1	2	3
4	5	6	7	8	9	10
11	12	13	14	15	16	17
18	19	20	21	22	23	24
25	26	27	28			

The third Thursday in February 2007 is the 15th.

See day, leap year, month, year

## calliper

A measuring instrument similar to compasses with curved legs for measuring thickness (diameter) of curved (convex) objects or, turned outwards, for measuring cavities.

### Example

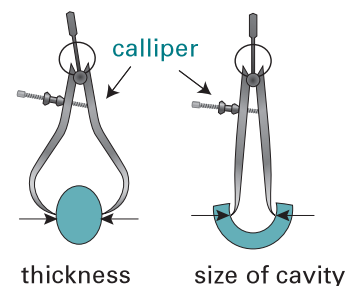

See compasses, concave, convex

## cancelling

A method of changing a fraction to its simplest form.

### Examples

- (i) Divide both numerator and denominator by three (common factor).

$$\frac{15 \div 3}{21 \div 3} = \frac{15 \cancel{\div 3}^5}{21 \cancel{\div 3}_7} = \frac{5}{7}$$

- (ii) Divide across.

$$\frac{3 \cancel{15}}{2 \cancel{22}} \times \frac{\cancel{33}^3}{\cancel{40}_8} = \frac{3 \times 3}{2 \times 8} = \frac{9}{16}$$

See denominator, fraction, numerator, simple fraction, simplify

## capacity

How much a container can hold. The number of cubic units a container can hold is called the capacity or volume of the container. Volume is the actual amount of material in the container.

Units of capacity are:

cubic centimetre  $\text{cm}^3$

cubic metre  $\text{m}^3$

millilitre mL

litre L

kilolitre kL

megalitre ML

1 mL = 1  $\text{cm}^3$

1000 mL = 1 L = 1000  $\text{cm}^3$

1000 L = 1 kL = 1  $\text{m}^3$

### Example

An eye dropper holds about 1 millilitre of liquid, which fills one cubic centimetre.

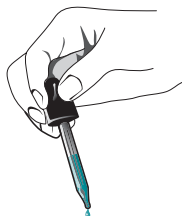

See section Metric relationships on page 149, volume

## cardinal number

The number of all elements (members) in a set. When we count, we give each element one number, starting with 1. These numbers are in sequence. The last number given is the cardinal number of the set.

### Example

How many balloons?

The cardinal number of this set of balloons is 5.

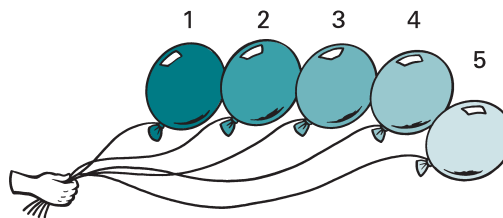

See counting, sequence, set

## Carroll diagram

A method of recording a classification activity (used by Lewis Carroll).

### Example

	black	not black
square		
not square		

See attribute, classify, diagram, sorting

## carrying

Another word for regrouping.

### Example

$$\begin{array}{r} 25 \\ + 18 \\ \hline 33 \end{array}$$

Add  $5 + 8 = 13$ .  
Write 3 in unit column and carry 1 into tens column.

See regroup

## Cartesian coordinates

See coordinates

## CC

A symbol sometimes used to show cubic centimetre. The correct symbol is  $\text{cm}^3$ .

See cubic centimetre

## Celsius scale

See C, degree Celsius, temperature

## CE

(Common Era)

Indicates the same period as AD.

CE can be used in place of AD.

See AD, BC

## cent

(Symbol: c)

One cent is one hundredth of a dollar.

$$\begin{aligned} 1\text{c} &= \$0.01 \\ \$1 &= 100\text{c} \end{aligned}$$



One cent used to be the smallest coin in Australian currency. Now it is the five-cent coin.



See dollar

## centi

A prefix meaning one hundredth.

### Example

One centimetre is one hundredth of a metre.

$$1\text{ cm} = 0.01\text{ m}$$

See centimetre, decimal place-value system, length, see Decimal system prefixes on page 153

## Centigrade

Old name used for a temperature scale divided into 100 degrees. We now call it the Celsius scale.

See degree Celsius, temperature

## centimetre

(Symbol: cm)

A unit of length.

$$1\text{ cm} = 0.01\text{ m}$$

$$100\text{ cm} = 1\text{ m}$$

### Example

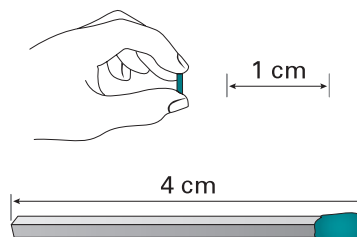

This match is 4 centimetres long.

See length, unit of measurement

## centre

A point that is the same distance from all points of a circle, a sphere, etc.

### Example

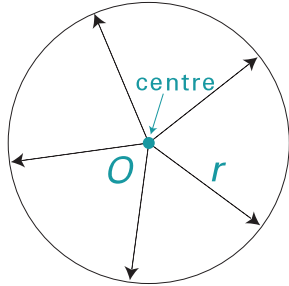

See circle, circumference, radius

## century

One hundred.

### Examples

100 years, 100 runs in cricket, etc.

From 1 January 1901 to 31 December 2000 is the 20th century.

The 21st century began on 1 January 2001.

## chance

A likelihood of an event happening.

See probability

## chance event

An event of which the outcome is uncertain.

For some events we can predict a possible outcome, but we can never be sure.

### Examples

Tossing a coin, rolling a die, drawing a coloured marble from a bag

See probability

## checking

A way of making sure that an answer is correct. One way of checking is by using the inverse operation.

### Examples

(i) Addition is checked by subtraction.

$$\begin{array}{r} 15 \\ + 28 \\ \hline 43 \end{array} \quad \begin{array}{r} 43 \\ - 28 \\ \hline 15 \end{array}$$

The answer 43 is correct.

(ii) Division is checked by multiplication.

$$\begin{array}{r} 14 \text{ (r2)} \\ 4 \overline{) 58} \\ \underline{4} \phantom{0} \\ 18 \\ \underline{16} \\ 2 \end{array} \quad \begin{array}{r} 14 \text{ quotient} \\ \times 4 \text{ } \times \text{ divisor} \\ \hline 56 \\ + 2 \text{ add remainder} \\ \hline 58 \text{ dividend} \end{array}$$

The answer 14 (r2) is correct.

See inverse, inverse operations

## chord

A line joining two points on a circle.

### Examples

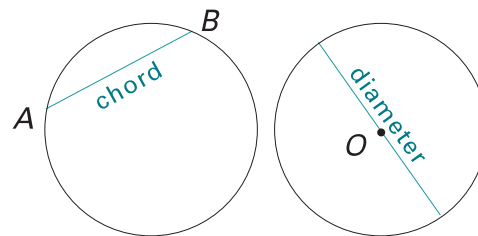

The diameter is the longest chord in a circle.

See circumference, diameter

## chronological order

Events arranged by the date or time when they happened.

*Example*

### THE HISTORY OF $\pi$

Time	Who/Where	Value of $\pi$
2000 BC	Babylonia	$3\frac{1}{8}$
300 BC	Archimedes	$3\frac{10}{71}$ to $3\frac{1}{7}$
1220 AD	Fibonacci	3.141 818
1665	Newton	3.141 592 653 589 7932
1705		$\pi$ sign was first used
1949	ENIAC computer	$\pi$ correct to 2035 decimal places
1984	Tokyo	$\pi$ computed to 16 million decimal places

See pi, time line

## circle

The set of all points in a plane which are at the same distance (radius  $r$ ) from a given point  $O$  (centre).

*Example*

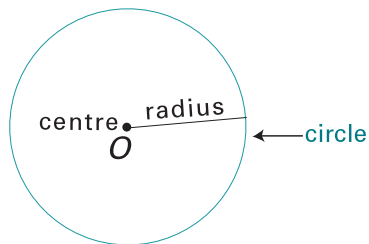

See centre, circumference, diameter, plane, radius

## circle graph

See pie graph

## circular

In the form of a circle; round.

*Example*

A merry-go-round is circular.



See circle

## circumference

The perimeter of a circle. The distance around a circle.

If the radius is  $r$  units, then the circumference  $C$  is  $2\pi r$  units.

*Example*

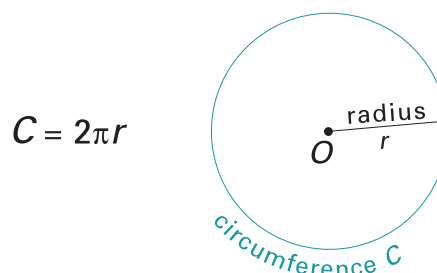

When the diameter  $d$  is measured, then the circumference  $C$  is  $\pi d$  units.

*Example*

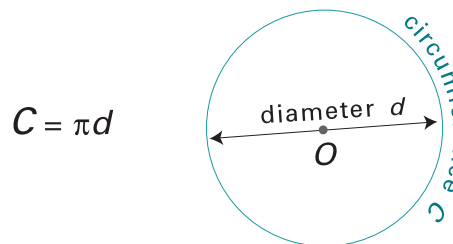

See circle, diameter, perimeter, pi

## class

A group, set, or collection of things.

### Example

Triangles, squares, rectangles and kites belong to the class of polygons.

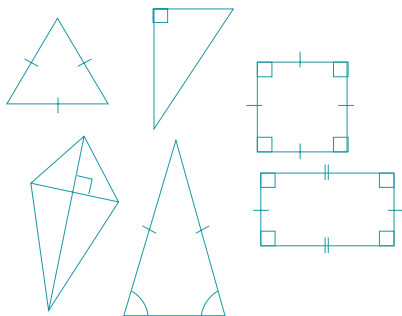

See classification, classify

## classification

Arrangement into classes, sets or groups, according to attributes.

### Examples

	not green	green
not		

Have pets	Don't have pets
Quong	Halima
Kelly	Nick
Grant	Dean
Toula	Anna
Ali	Scott
Claire	Sachiko

See attribute, property

## classify

Sort objects, ideas or events into groups, classes or hierarchies according to one or more properties or attributes.

See attribute, property, sorting

## clockwise

The direction in which the hands of a clock normally travel.

### Example

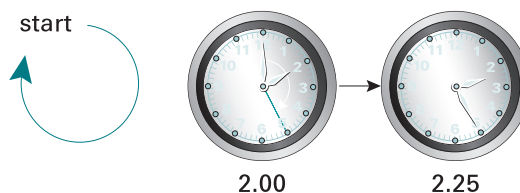

The hands on this clock have moved in a clockwise direction.

Screws and bottle tops are tightened clockwise.

See anticlockwise

## closed curve

A curve which starts at a point and comes back to that point.

### Examples

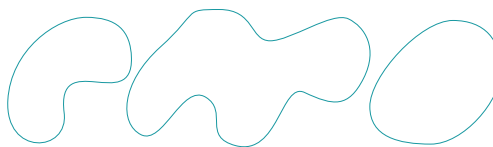

(i) Simple closed curves

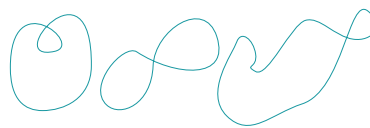

(ii) Closed curves that are not simple



(iii) Regular closed curves

See circle, curve, ellipse, open curve



## column graph

A graph that uses columns of different lengths to represent various kinds of information.



### Example

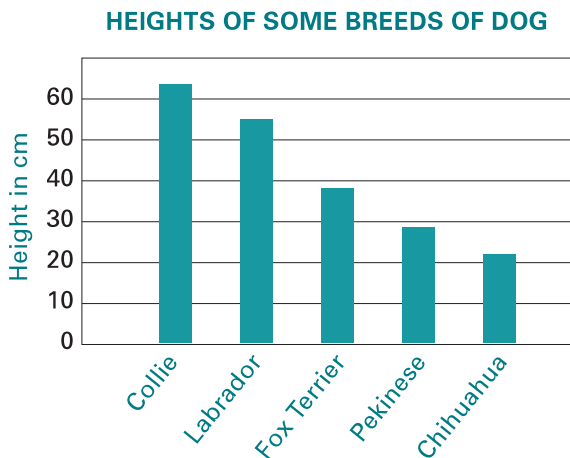

See bar graph, column

## combination

A way of arranging the objects in a group.

### Example

There are four shapes in this group.



The possible pairings are:

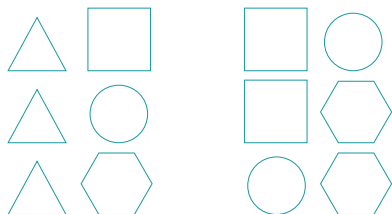

Each pairing is called a combination.

The order in which the shapes are placed is not important.

See permutation, set, subset

## combined shapes

(complex)

Plane shapes that are made of two or more polygons.

### Example

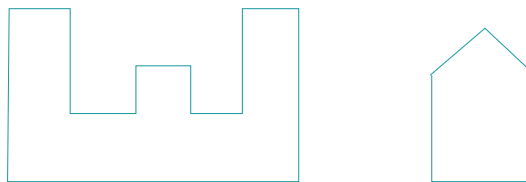

To calculate the area of a combined shape, divide it into simple shapes. Find the area of each shape, then add those to find the area of the combined shape.

### Example

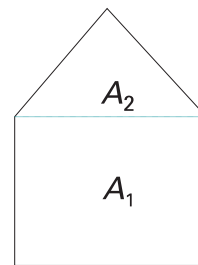

$$\text{Area} = A_1 + A_2$$

## commission

A commission is a fee or percentage of sales paid to a sales person.

### Example

A car sales person receives \$500 for every new car sold. The sales person receives a commission of \$500.

## common denominator

For two or more fractions, a common denominator is a number into which all the denominators divide exactly.



**Example**

For the fractions  $\frac{1}{2}$  and  $\frac{1}{3}$  a common denominator is 6, and also 12, 18, 24, etc.

6 is the lowest common denominator (LCD).

*See denominator, fraction, lowest common denominator*

**common fraction**

*See simple fraction*

**commutative property of addition**

The order in which two or more numbers are added does not affect the answer (sum).

**Example**

$$\begin{aligned} 6 + 4 &= 4 + 6 \\ 10 &= 10 \end{aligned}$$

*See associative property of addition, sum*

**commutative property of multiplication**

The order in which two or more numbers are multiplied does not affect the answer (product).

**Example**

$$\begin{aligned} 3 \times 8 &= 8 \times 3 \\ 24 &= 24 \end{aligned}$$

*See associative property of multiplication, product*

**comparison**

Identifying whether objects, measures or quantities are the same or different.

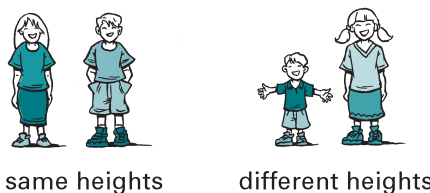
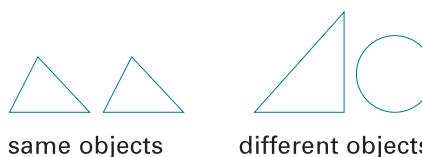
**Examples**

*See division, ratio*

**compass**

An instrument which shows direction. Used in ships, aeroplanes, etc.

**Example**

*See bearing, direction*

**compasses**

(pair of)

An instrument used to draw a circle and to mark off equal lengths. Often called a compass, for short.

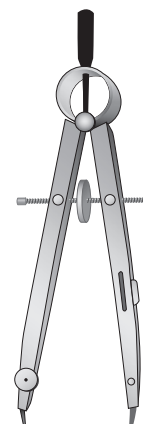

## complement

Something that completes or fills up a whole.

See complementary addition, complementary angles



## complementary addition

(i) Finding the amount to complete a set.

### Example

What has to be added to seven to make ten?

$$7 + \square = 10$$

$$7 + 3 = 10$$

Answer: Three has to be added.

(ii) Counting on to a higher total (as change is given after a purchase).

### Example

Shopping costs \$17.50. I pay with a \$20 note. I get \$2.50 change. This is evaluated by finding what must be added to \$17.50 to make \$20.

(iii) The method of 'subtracting' which converts the subtraction question to an addition question.

### Example

$$21 - 19 = 2$$

Instead of taking nineteen away from twenty-one we think how much must be added to nineteen to make twenty-one.

See addition, set, subtraction

## complementary angles

Two angles that together measure  $90^\circ$ .

### Example

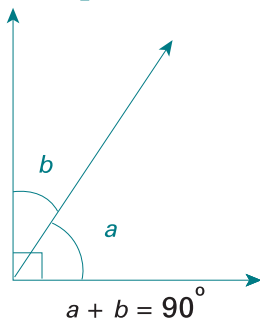

$\angle a$  and  $\angle b$  are complementary.

$\angle a$  is the complement of  $\angle b$ .

$\angle b$  is the complement of  $\angle a$ .

See supplementary angles

## complex fraction

A fraction whose numerator, denominator, or both, are fractions.

### Examples

$$\frac{\frac{1}{2}}{5} \quad \frac{3}{\frac{4}{7}} \quad \frac{\frac{1}{2}}{\frac{3}{4}} \quad \frac{\frac{a}{b}}{\frac{c}{d}}$$

Note: To simplify a complex fraction means the same as division of fractions. It can be done in two ways.

### Example

Divide  $\frac{1}{2}$  by  $\frac{2}{3}$ .

$$1 \quad \frac{1}{2} \div \frac{2}{3} = \frac{1}{2} \times \frac{3}{2} = \frac{3}{4}$$

$$2 \quad \frac{\frac{1}{2}}{\frac{2}{3}} = \frac{1 \times 3}{2 \times 2} = \frac{3}{4}$$

## composite number

A number with factors other than itself and one.

### Examples

$$12 = 12 \times 1 = 3 \times 4 = 3 \times 2 \times 2$$

$$33 = 33 \times 1 = 3 \times 11$$

Both twelve and thirty-three are composite numbers.

$$17 = 17 \times 1 \quad 23 = 23 \times 1$$

Seventeen and twenty-three are not composite numbers.

Numbers which have no other factors except themselves and one, such as seventeen, are called prime numbers.

Every whole number greater than one is either:

(i) a prime number  
(2, 3, 5, 7, 11 ...)

or

(ii) a composite number  
(4, 6, 8, 9, 10, 12, 14 ...).

See factors, prime number

## compound operation

See order of operations

## computation

Using addition, subtraction, multiplication and/or division to find the answer. These operations can be performed mentally, in writing or with the help of calculating aids such as an abacus, tables, calculators or computers.

See abacus, calculator, table

## compute

To work out or calculate.

*Example*

$$\begin{array}{r} 14.7 \\ \times 23.21 \\ \hline 47 \\ 940 \\ 14100 \\ 15087 \end{array}$$

## concave

A shape that is hollowed or rounded inward like the inside of a bowl.

*Examples*

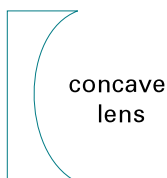
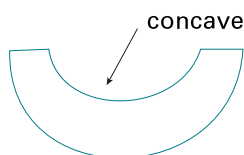

See convex

## concentric circles

Circles that are in the same plane and have the same centre are concentric.

*Example*

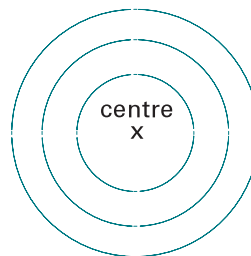

See annulus, circle, plane

## concurrent lines

Lines that intersect at the same point.

*Example*

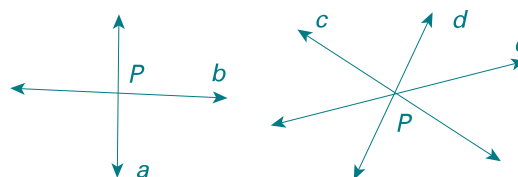

See intersect, parallel lines

## cone

A solid which has a circular base and comes to a point at the top, similar in shape to an ice-cream cone.

*Examples*

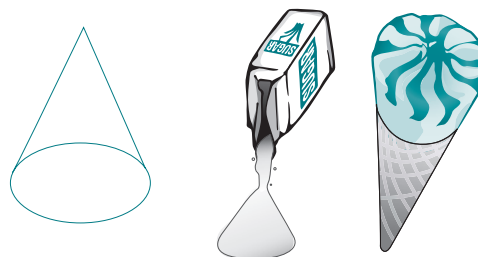

See right 3D shape, solid



**congruent**

(Symbol:  $\equiv$ )

Exactly equal. Matching exactly. Two figures are congruent if they have the same shape and the same size.



*Examples*

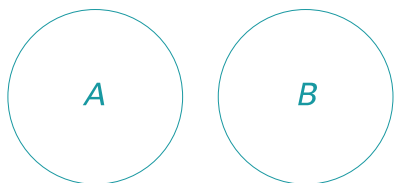

Circle A is congruent to circle B.

$$A \equiv B$$

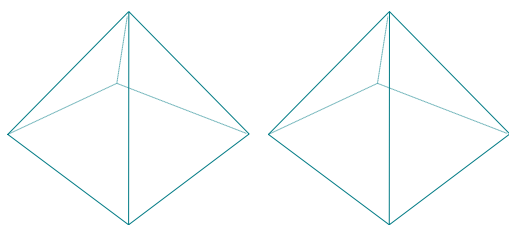

congruent pyramids

See corresponding angles, similar

**conic section**

A figure (circle, ellipse or parabola) formed when a right circular cone is cut by a plane.

*Example*

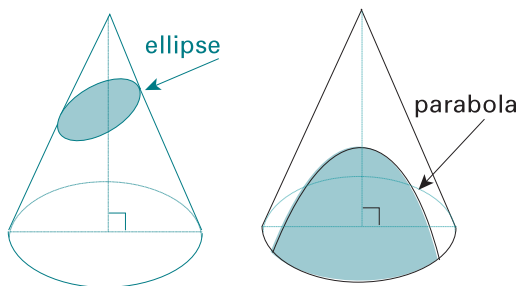

See circle, ellipse, parabola

**consecutive numbers**

Numbers that follow each other in a sequence.

*Examples*

1 2 3 4 5 6 7 8

$\frac{1}{7}$   $\frac{2}{7}$   $\frac{3}{7}$   $\frac{4}{7}$   $\frac{5}{7}$   $\frac{6}{7}$

0.1 0.2 0.3 0.4

See sequence

**conservation of area**

Retaining the same area.

*Examples*

(i) The three triangles have the same area.

$A = \frac{1}{2} \times 2 \text{ cm} \times 2.5 \text{ cm} = 2.5 \text{ cm}^2$ , even though their shapes are different.

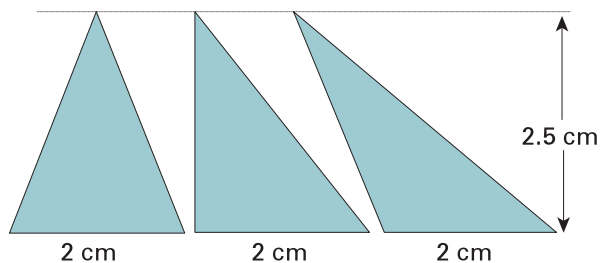

(ii) The three shapes have the same area of  $3 \text{ cm}^2$ .

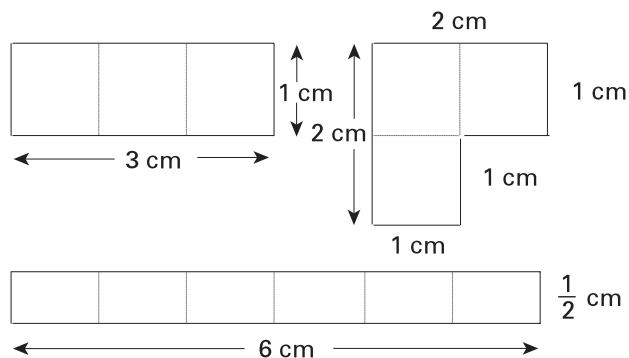

See area

## constant

A number that always has the same value, unlike a variable.

*Example*

$$2c + 6$$

6 is the constant.

*See variable*

## continuous data

Data that consist of measurements that can take on any decimal value along a continuous scale.

*Example*

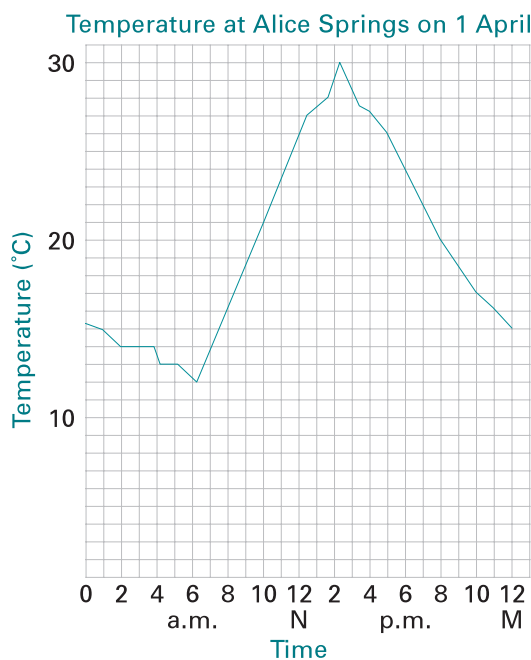

Other examples are mass and distance.

*See data, discrete data*

## converging lines

Two or more lines that meet at the same point.

*Example*

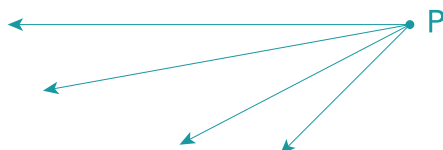

*See perspective*

## convex

Shaped like the outside of a circle or a sphere. The opposite of concave.

*Example*

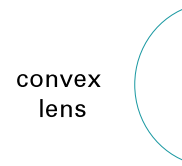

*See concave*

## coordinates

A pair of numbers or letters that show the position of a point on the plane. The first number is always the  $x$ -coordinate, the second is the  $y$ -coordinate.

*Examples*

- (i) Each point on the plane is given an ordered pair of numbers, written in parentheses.

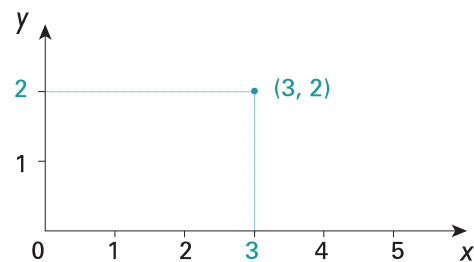

Point (3, 2) has the  $x$ -coordinate 3, and the  $y$ -coordinate 2.

- (ii) The position of Judith Avenue is B3.

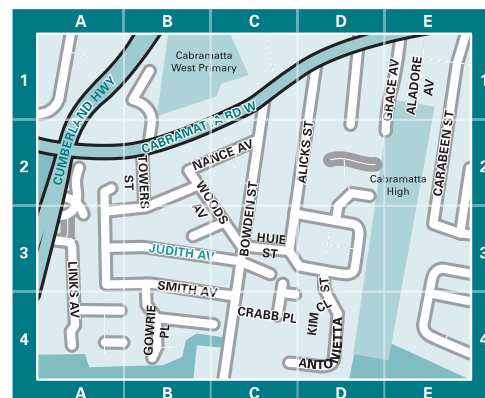

*See axis, intersection, ordered pair, origin*

## coplanar

Lying or being in the same plane.

*Example*

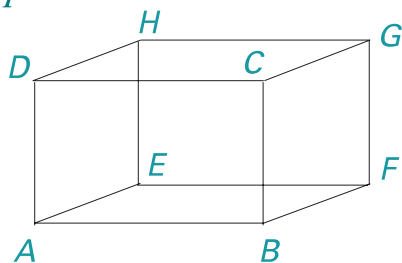

$C, D, G$  and  $H$  are coplanar points.

$AB$  and  $CG$  are not coplanar.

## correspondence

See many-to-one correspondence, one-to-one correspondence

## corresponding angles

Angles in the same or similar position. In congruent shapes, corresponding angles have the same size (are congruent).

*Example*

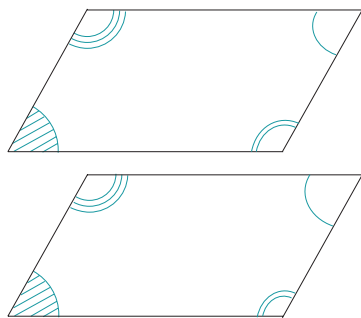

These parallelograms are congruent. Corresponding angles are marked by the same symbol.

See congruent, parallel lines, vertically opposite angles

## corresponding sides

In congruent shapes, like the triangles below, the sides  $AB$  and  $XY$ ,  $BC$  and  $YZ$ , and  $CA$  and  $ZX$  are corresponding sides.

*Example*

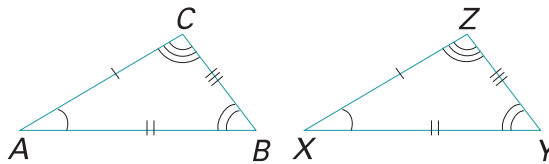

See congruent

## cost price

Price at which something is produced or bought.

*Example*

A car dealer buys a car for \$10 000. The cost price of the car is \$10 000.

See selling price

## counting

Giving one number to every item in a set. These numbers are in a sequence.

*Example*



The numbers 1, 2, 3, 4, 5 ... are counting numbers.

See cardinal number, sequence, set

## counting number

A member of the set of numbers used in counting:  $\{1, 2, 3, 4 \dots\}$ .

Note: zero is not a counting number.

See cardinal number, number

## counting system

A way of finding out how many objects there are.

See decimal place-value system

## cross-section of a solid

The face that is made when a solid is cut through by a plane.

### Example

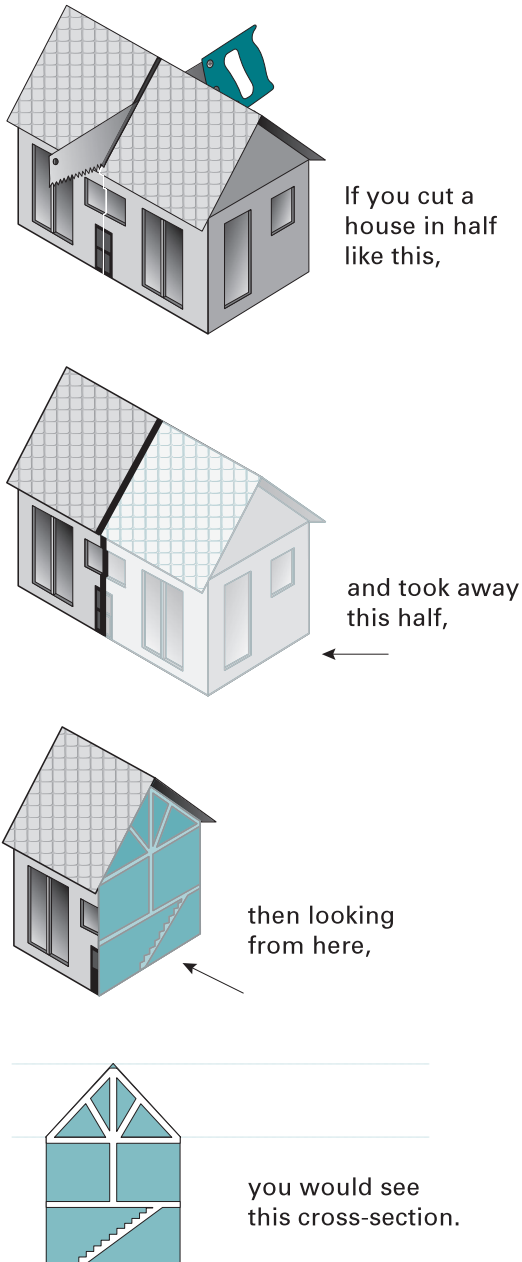

See face, front view, plan, plane, section, side view

## cube

A solid, shaped like a box, with twelve equal edges, six equal square faces and eight corners. A cube is a type of cuboid.

### Examples

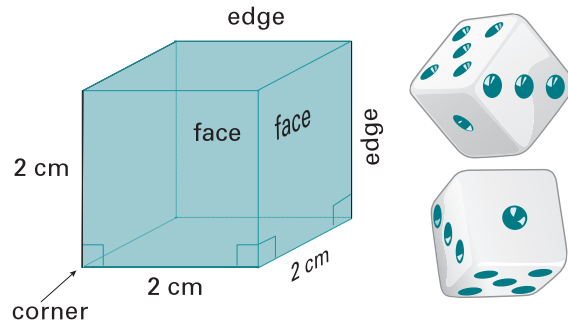

This is a diagram of a 2 cm cube.

See cuboid, face, hexahedron, solid

## cubed number

$4^3$  ← index  
↑  
base

$4^3$  means  $4 \times 4 \times 4$  or 64.

We read it as '4 cubed', '4 cube' or '4 to the third power'.

See index, index notation, power of a number, square number

## cubic centimetre

(Symbol:  $\text{cm}^3$ )

A cubic centimetre is a unit for measuring volume.

### Example

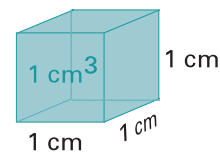

It is a cube with edges of 1 cm.

$1 \text{ cm}^3$  has a capacity of 1 millilitre.

See capacity, cube, unit of measurement, volume

## cubic metre

(Symbol:  $m^3$ )

A cubic metre is a unit for measuring volume.

### Example

A cube whose edges are 1 metre long has a volume of 1 cubic metre.

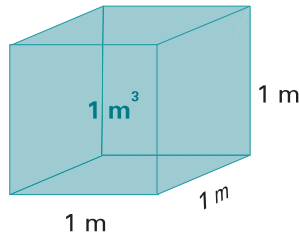

$$1 \text{ m}^3 = 1\,000\,000 \text{ cm}^3$$

$1 \text{ m}^3$  has a capacity of 1 kilolitre.

See capacity, unit of measurement, volume

## cubic unit

A measure of volume.

See cubic centimetre, cubic metre, volume

## cuboid

A shape such as a shoe box. A cube-like prism. It has twelve edges, six faces and eight corners. The opposite faces are the same shape and size.

### Examples



These packets are cuboids.

See cube, face, hexahedron, prism

## curve

A line of which no part is straight. There are open curves and closed curves.

### Examples

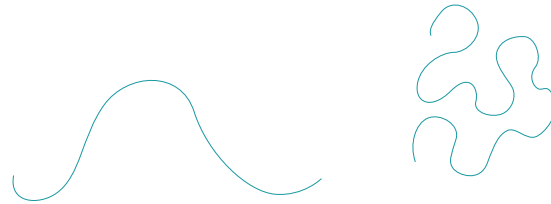

open curves

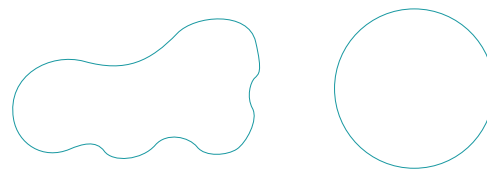

closed curves

See closed curve, open curve

## cycle

A system that repeats itself in time.

### Example

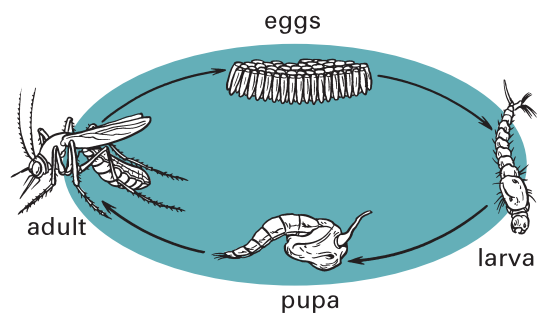

The breeding cycle of mosquitoes



## cycle game

A game that follows a set of rules in which the last move returns the player to the starting point.

### Examples

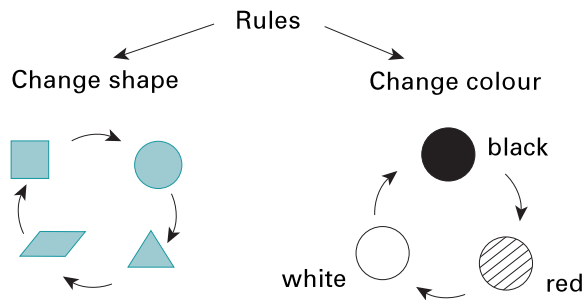

*See rule*

## cylinder

A cylinder is a shape like a can. It is a solid with two circular faces at right angles to a curved surface.

### Examples



*See capacity, right 3D shape*





---

## data

A general term used to describe a collection of facts, numbers, measurements or symbols.

### *Example*

Students' scores in a maths test were 15, 16, 18, 19, 19, 20, 21, 21, 22 marks.

---

## date

Specified time: day, month or year, at which something takes place.

### *Example*

The date on my letter is 10 May 1998.

---

## day

The 24-hour period it takes the Earth to turn once on its axis.

---

## days of the week

Weekdays are: Monday, Tuesday, Wednesday, Thursday and Friday.

Weekend days are: Saturday and Sunday.

---

## deca

Prefix that means 10.

*See* decade, decagon, decahedron

---

## decade

Ten years.

---

## decagon

A polygon with ten sides.

### *Example*

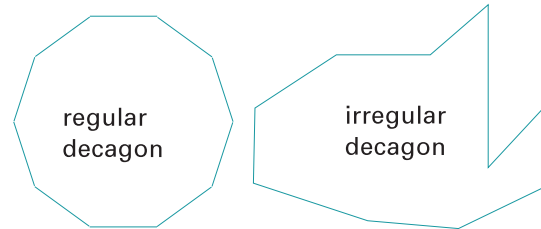

*See* polygon

---

## decahedron

A polyhedron with ten faces.

### *Example*

This decahedron has been made by joining two pyramids and cutting their tops off.

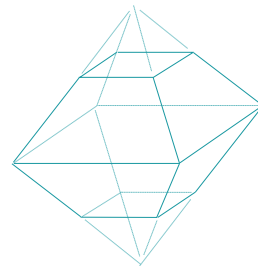

*See* frustum, polyhedron

---

## decimal

Containing ten parts.

---

## decimal fraction

A fraction written as a decimal.

### *Example*

$$\frac{1}{10} = 0.1$$

simple fraction
decimal fraction

*See* decimal place-value system

## decimal place-value system

A numeration system with ten as a base for grouping. Commonly called the 'base ten' system.

$10^6$	$10^5$	$10^4$	$10^3$	$10^2$	$10^1$	$10^0$	$10^{-1}$	$10^{-2}$	$10^{-3}$
millions	hundred thousands	ten thousands	thousands	hundreds	tens	units	tenths	hundredths	thousandths

See base, decimal point, place value

## decimal point

A point or comma (used in Europe) that separates a decimal fraction from the whole number.

*Example*

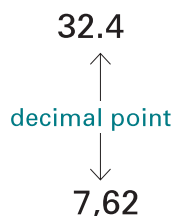

See point

## decimal system

See decimal place-value system

## declination

The slope indicating where an object is compared to a vertical or horizontal position.

*Example*

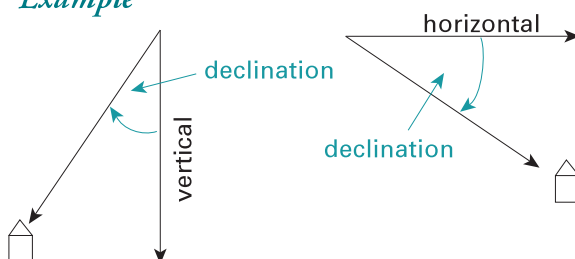

## decrease

Make smaller. We either subtract a number or divide by a number.

*Examples*

(i) Decrease this length by 2 cm.

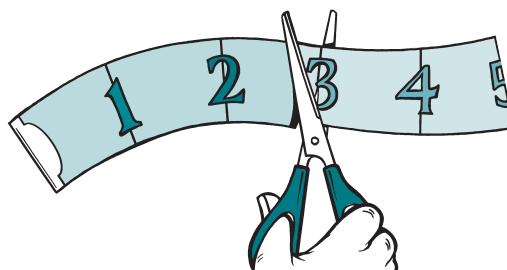

$$5 \text{ cm} - 2 \text{ cm} = 3 \text{ cm}$$

We decreased 5 cm to 3 cm by cutting 2 cm off.

(ii) Decrease \$100 five times.

$$\$100 \div 5 = \$20$$

\$100 decreased five times is \$20.

See increase, progression

## degree

(Symbol:  $^{\circ}$ )

(i) In geometry, a degree is a unit for measuring angles.

*Examples*

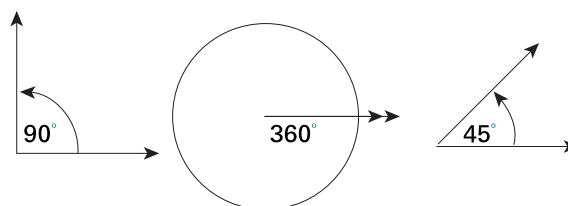

1 degree is divided into 60 minutes

$$1^{\circ} (\text{degree}) = 60' (\text{minutes})$$

1 minute is divided into 60 seconds

$$1' (\text{minute}) = 60'' (\text{seconds})$$

(Don't confuse these with the symbols for feet and inches.)

(ii) The unit for measuring temperature.

See angle, degree Celsius, geometry, temperature, unit of measurement



## diagram

A name given to pictures or sketches of geometric figures. It is also used for simplified drawings which explain or describe other things.

### Examples

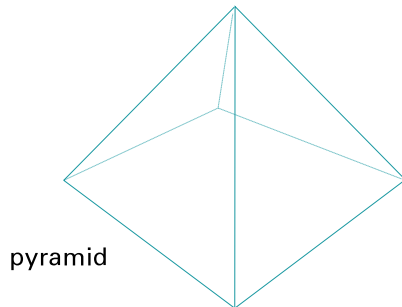

### THE WATER CYCLE

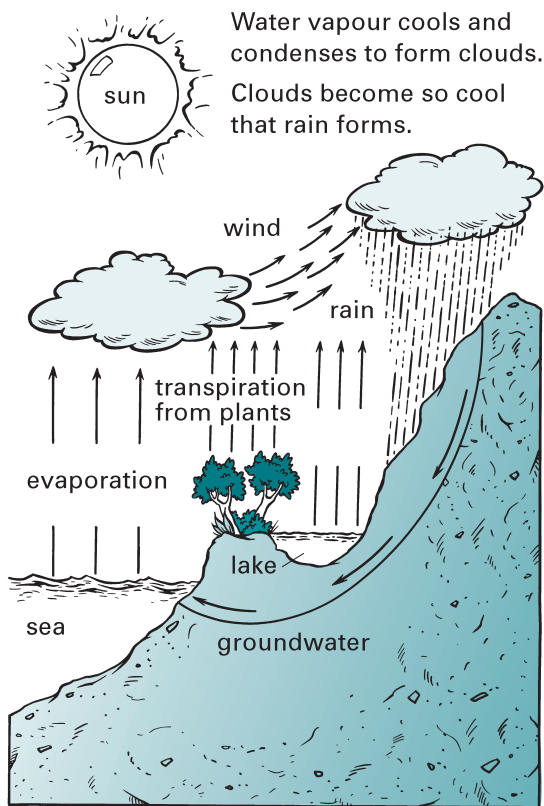

Water flows back into the sea, lakes and rivers.

See Carroll diagram

## diameter

A line segment joining two points of a circle and passing through the centre of the circle. Diameter equals two radii ( $r$ ).

### Example

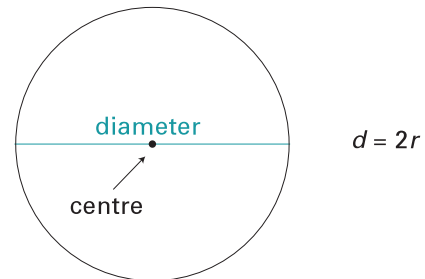

See chord, circle, circumference, line segment, radius

## diamond

A two-dimensional shape with four equal sides where the angles are not right angles.

The correct name is rhombus.

### Examples

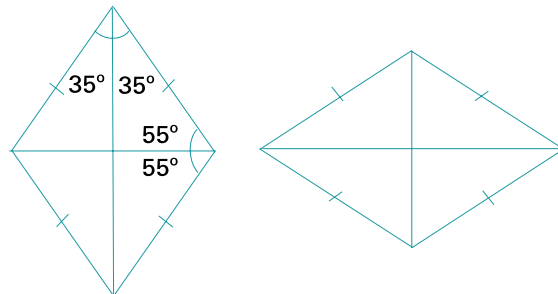

See dimension, rhombus

## die

(Plural: dice)

A regular polyhedron, usually a cube, marked with a certain number of spots or numerals. Used in number games.

### Examples



one die



two dice

Some dice have more than 6 faces.

## difference

The amount by which two numbers differ.

*Example*

$$10 - 3 = 7$$

↑ ↑  
 minuend      difference  
↑ ↑  
                  subtrahend

The difference between ten and three is seven.

See minuend, subtract, subtraction, subtrahend

## digit

Numerals 0, 1, 2, 3, ... 9 are called digits; we can also call them one-digit numbers.

*Examples*

4 is a one-digit number.

56 is a two-digit number.

813 is a three-digit number.

See place holder, place value

## digital clock

A clock or a watch that shows time by numbers. It has no clock hands.

*Example*



This clock shows twenty to ten.

See a.m., analogue clock, p.m., time interval

## dimension

A property that can be measured, related to plane and space.

(i) One-dimensional (1D) objects have only length.

*Examples*

lines, curves

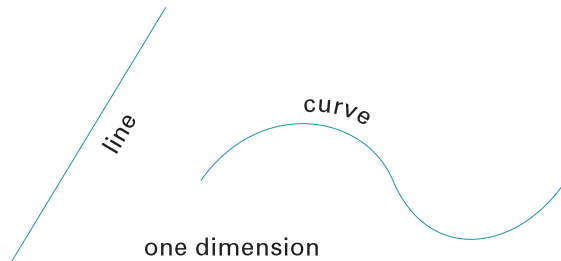

(ii) Two-dimensional (2D) objects have length and width.

*Examples*

plane figures—polygons, circles

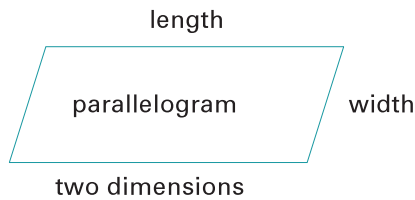

(iii) Three-dimensional (3D) objects have length, width and height.

*Examples*

solids—cubes, pyramids

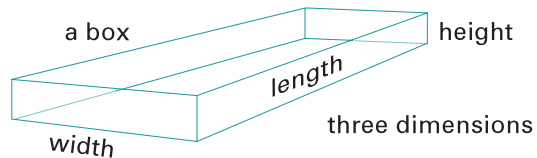

Note: A point (dot) has no dimensions.

See one-dimensional, plane, space, three-dimensional, two-dimensional

## direct proportion

See proportion

## directed angle

The amount of turning from one ray (or arm of an angle) to the next, used in taking bearings.

### Example

The directed angle (bearing) is N 40° E.

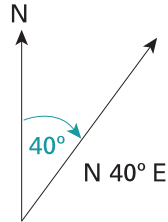

See arm of an angle, bearing, ray

## directed numbers

Numbers that have + or – signs on them. They are also called integers. We can show them on a number line or axes.

### Example

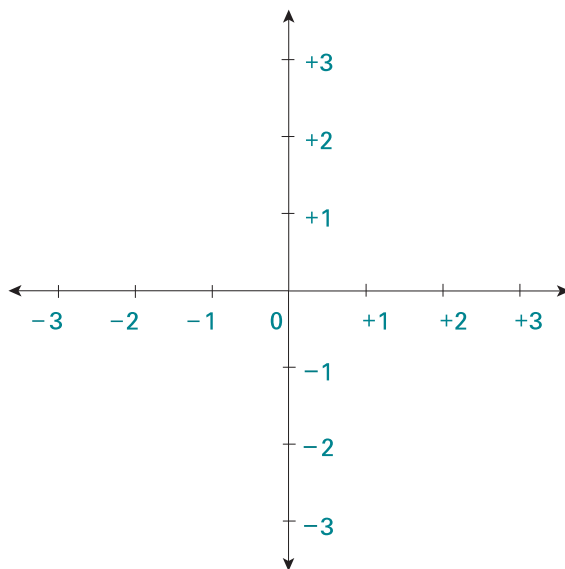

See integers

## direction

(i) The way to go.

### Examples

Left, right, up, down, above, below, inside, outside, near, from behind, forwards, backwards, etc.

(ii) Compass directions.

north (N)  
east (E)  
south (S)  
west (W)  
north-east (NE)  
south-east (SE)  
south-west (SW)  
north-west (NW)



See anticlockwise, clockwise, compass

## discount

If the price of something is reduced, it is sold at a discount.

Note: Discounts are often offered as a percentage of the selling price.

### Example

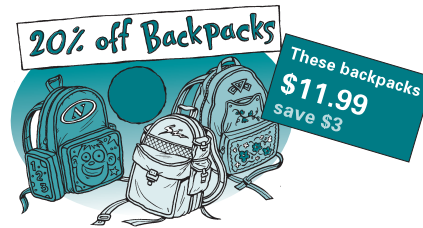

## discrete data

A set of data that can be counted. They are exact.

### Example

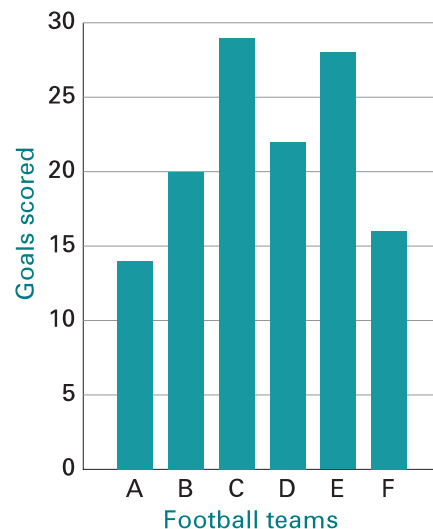

See continuous data, data

## displacement

A change in the position of an object or of a quantity of material.

*Example*

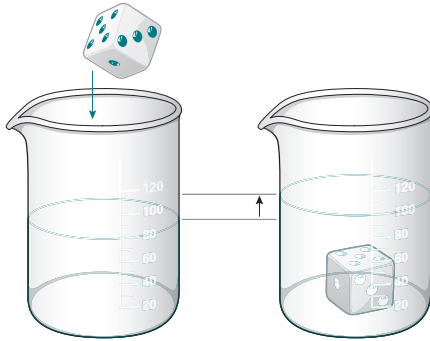

The quantity of water displaced by an immersed object

The water displacement method is used to measure the volume of objects. The volume of displaced water is equal to the volume of the object.

*See volume*

## distance

The length between one point and another.

*Example*

Distance between the points of the compasses is 5 centimetres.

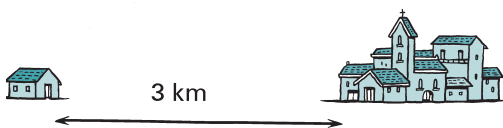
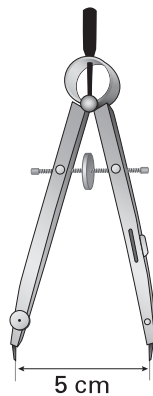

Distance from my house to town is 3 kilometres.

## distribute

Give share of something to each; deal out as in division.

*Example*



Mum is going to distribute the cakes.

*See division*

## distribution

*See frequency distribution*

## distributive law

$$a(b \pm c) = ab \pm ac$$

Every term inside the grouping symbols is multiplied by the term that is immediately outside. This is also called expanding the expression or removing the grouping symbols.

*See brackets, expand, expanded notation*

## dividend

A number which is to be divided by another number.

*Example*

$$\begin{array}{ccccc}
 24 & \div & 6 & = & 4 \\
 \uparrow & & \uparrow & & \uparrow \\
 \text{dividend} & & \text{divisor} & & \text{quotient}
 \end{array}$$

24 is the dividend.

*See divisor, quotient*



## divisibility tests

A number is divisible by another if, after dividing, there is no remainder.

**A number is ...**

divisible by	if	Examples
2	the last digit is even	2, 4, 6, ... 122 ... 358 ... 1000
3	the sum of all digits can be divided by 3	261: $2 + 6 + 1 = 9$ 3672: $3 + 6 + 7 + 2 = 18$ 18: $1 + 8 = 9$
4	the last two digits are divisible by 4	1024: $24 \div 4 = 6$
5	the last digit is 5 or 0	15, 70 ...
6	the last digit is even and the sum of its digits is divisible by 3	7446: $7 + 4 + 4 + 6 = 21$
7	there is no divisibility test	
8	the last 3 digits are divisible by 8	75384: $384 \div 8 = 48$
9	the sum of its digits is divisible by 9	3123: $3 + 1 + 2 + 3 = 9$
10	the number ends in 0	10, 20, 30 ...

Important: No number can be divided by 0.

*See factors, remainder*

## divisible

A number is divisible by another number if, after dividing, there is no remainder.

*Example*

$$72 \div 9 = 8 \quad 72 \div 8 = 9$$

Seventy-two is divisible by nine and also by eight.

Nine and eight are factors of seventy-two.

*See factors, remainder*

## division

Division is a mathematical operation which can be interpreted in several different ways:

(i) Grouping (quotition).

*Example*

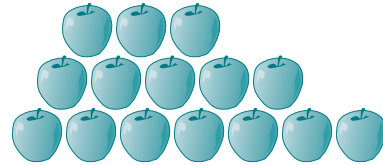

How many groups of 3 can be made with 15 apples?

The apples are to be placed into groups of equal size, 3 to a group. The problem is to find out how many groups there will be.

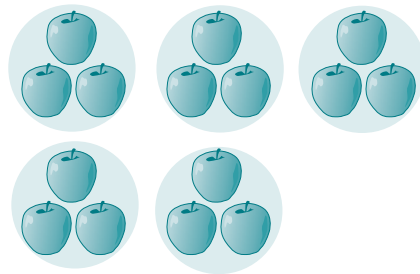

$$15 \div 3 = 5$$

There are 5 groups of 3 apples.

Repeated subtraction is a form of grouping.

▼ **division continued...**





(ii) Sharing (partition).

*Example*

Share 15 apples among 5 children. How many apples will each child get?



The apples are to be separated into 5 equal groups. The problem is to find how many there will be in each group.



$$15 \div 5 = 3$$

(iii) Ratio.

Comparison between two quantities.

*Example*

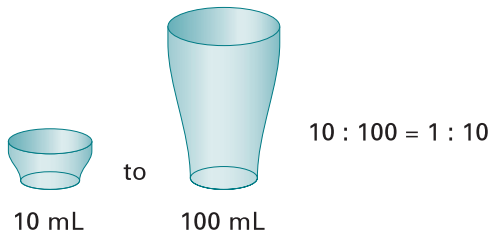

Ratio 1 : 10

Mixing 1 part of cordial and 10 parts of water to make a drink.

*See ratio*

**divisor**

A number which is to be divided into another number.

*Example*

$$\begin{array}{ccc} 24 & \div & 6 = 4 \\ \uparrow & & \uparrow \quad \uparrow \\ \text{dividend} & & \text{divisor} \quad \text{quotient} \end{array}$$

6 is the divisor.

*See dividend, quotient*

**dodecagon**

A polygon with twelve sides.

*Examples*

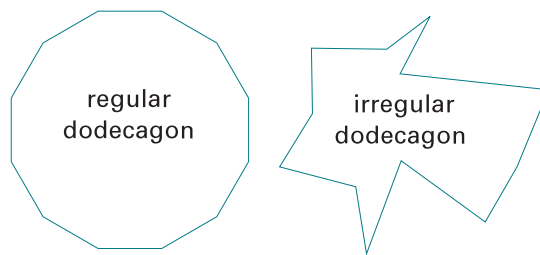

*See polygon*

**dodecahedron**

A solid (polyhedron) with twelve faces.

A regular dodecahedron is made by joining together twelve congruent regular pentagons.

*Example*

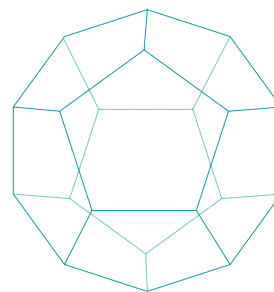

regular dodecahedron

*See pentagon, polyhedron, regular polyhedron*

## dollar

(Symbol: \$)

A unit of money, worth 100 cents.



See cent

## double

Twice as many, or the same again.

*Examples*



Double 8 is 16.

10 is double 5.



## dot paper

Paper printed with dots arranged in a pattern. It is used for drawing shapes, defining areas, games, etc., and to record work done on a geo-board.

*Examples*

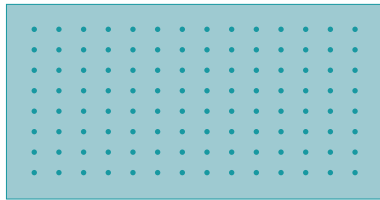

square dot paper

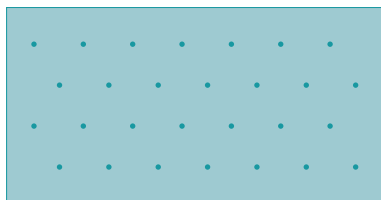

isometric dot paper

See geo-board, isometric paper, square paper

## dozen

Twelve items.

*Example*

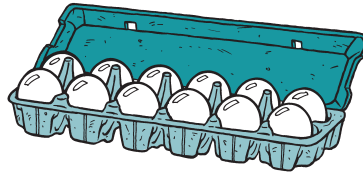

one dozen eggs = twelve eggs

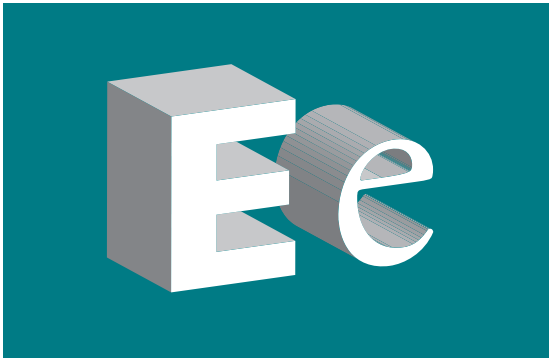

## elevation, angle of

*See angle of elevation*

## ellipse

A closed curve that looks like an elongated circle.

*Examples*

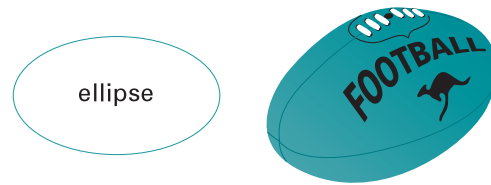

A football is elliptical in shape.

*See closed curve, parabola*

## edge

In geometry, the line that is the intersection of two plane faces.

*Examples*

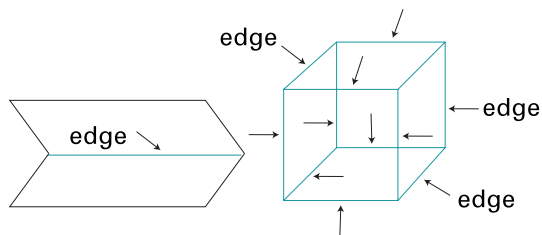



*See face, intersection, plane*

## element of a set

One of the individual objects that belong in (are members of) a set.

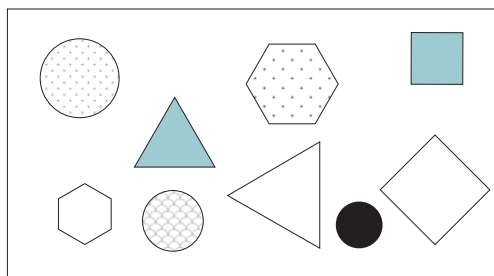
*Example*



 is an element of the set of shapes above.

*See cardinal number, set*

## enlargement

Making bigger. Enlargement is the most commonly used transformation. It can be made in many ways: using a grid, rays, by pantograph or a photocopier.

*Example*

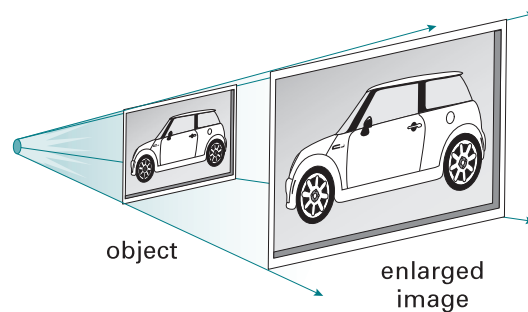

Rays were used to enlarge the picture.

*See pantograph, reduce, scale drawing, transformation*

## equal

(Symbol: =)

- (i) Identical in quantity.

*Example*

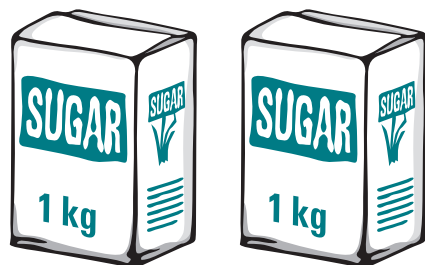

These two packets of sugar have an equal mass of one kilogram.

- (ii) Of the same value.

*Examples*



\$5 note equals five \$1 coins

- (iii) The sums  $1 + 8 = 3 + 6 =$   
 $10 - 1 = 2 + 7 =$   
 $4 + 5 = 9 + 0$

are equal because they are all different ways of representing number 9.

*See equality, equal sign*

## equaliser

A balance with numbered hooks placed at intervals along the beam so that number facts can be represented, and equality indicated, by balance.

*Example*

A unit mass on the fifth hook on one side would balance unit masses on the second and third hooks on the other side.

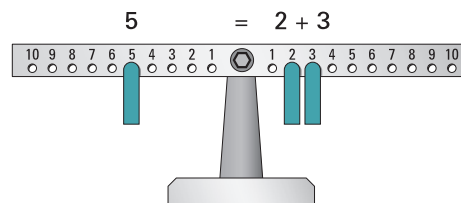

*See balance, equality*

## equality

The relation of being equal.

A statement that two expressions are equal, usually expressed as an equation.

*Example*

$$2 + 4 = 6$$

*See equal, equation, inequality*

## equally likely

Events which have the same chance of occurring are said to be equally likely.

*Example*

When a die is rolled fairly, the six numbers, 1, 2, 3, 4, 5 and 6, are equally likely to occur.

*See chance event, probability*

## equal sign

(Symbol: =)

The name of the symbol which means 'is equal to' or 'equals'.

It shows that:

$$\begin{array}{ccccccc} 3 & + & 5 & = & 8 \\ \uparrow & & \uparrow & & \uparrow \\ \text{this} & & & & \text{this} \\ & & & & \text{is equal to} \end{array}$$

*See equal, symbol*

## equation

A statement that two quantities are equal.  
An equation has two sides which are equal or balanced. There must be the equal sign.

### Example

$$x + 4 = 7$$

This equation is true only if  $x$  has the value of three.

The  $x$  and any other signs or letters used in equations to stand for a quantity are called place holders, pronumerals, or variables.

See equality, inequality, place holder, pronumeral, variable



## equidistant

The same distance apart at every point.

### Example

The distance between parallel lines is equal (the same) at every point.

See parallel lines

## equilateral

Having sides of equal length.

Square, regular pentagon, hexagon and other regular polygons have sides of equal length and angles of equal size.

### Examples

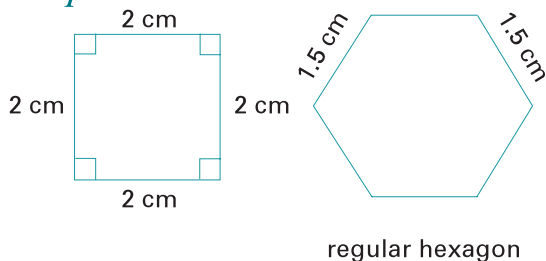

See equilateral triangle

## equilateral triangle

A triangle that has three sides of equal length and three equal angles.

### Examples

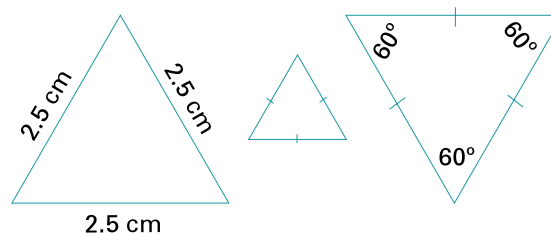

The angles of any equilateral triangle are always  $60^\circ$ .

See equilateral, triangle

## equivalent

Having the same value.

The same amount.

### Example



A \$2 coin is equivalent to two \$1 coins.

See equivalent fractions

## equivalent fractions

Fractions that name the same number or amount.

### Examples

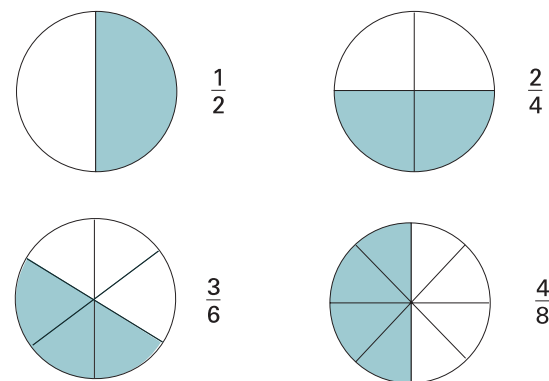

Fractions  $\frac{1}{2} = \frac{2}{4} = \frac{3}{6} = \frac{4}{8}$  are equivalent.

See equivalent, fraction

## estimate

- (i) A rough or approximate calculation.
- (ii) A number that has not been calculated accurately. Estimated answers are often needed when working with decimals.

### Example

In  $1.9 \times 3$  the estimate will be

$$2 \times 3 = 6$$

$$\therefore 1.9 \times 3 \approx 6$$

- (iii) Trying to judge or guess what a measure or result will be.

### Example

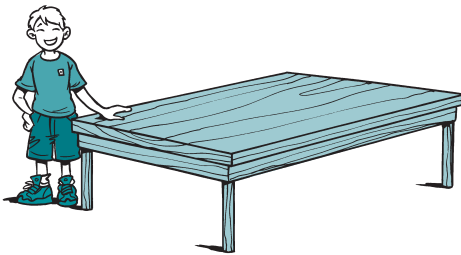

The table is 13 handspans long, that is roughly 2 metres.

See accurate, approximately, calculate, rounding

## evaluate

To find the value of.

### Examples

- (i) Evaluate  $21 \times 3$

$$\begin{array}{r} 21 \\ \times 3 \\ \hline 63 \end{array}$$

The value of  $21 \times 3$  is 63.

- (ii) Evaluate  $p + 3q$

Given that  $p = 2.5$  and  $q = 7$

$$\begin{aligned} p + 3q &= 2.5 + (3 \times 7) \\ &= 2.5 + 21 \\ &= 23.5 \end{aligned}$$

## even

Equally balanced, equal in number or amount.

### Example

$$\$5 = \$2.50 + \$1 + \$1.50$$

## even number

A number that is divisible by two. All even numbers finish with one of the digits: 0, 2, 4, 6 or 8.

See digit, divisible

## exact

Precise, accurate, correct in every way, not approximate.

See approximately

## exchange

- (i) When we go shopping, we exchange money for goods. Money is the medium of exchange.

### Example



\$2.30 is the price of the toy car.

- (ii) Multibase arithmetic blocks (MAB) can be exchanged.

### Example

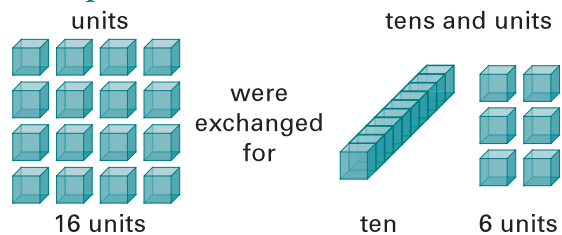

- (iii) Money can also be exchanged for money of equivalent value.

### Example



is the same amount as



See equivalent, multibase arithmetic blocks, rate



## expand

Write out in full.

### Examples

(i) Expand 4

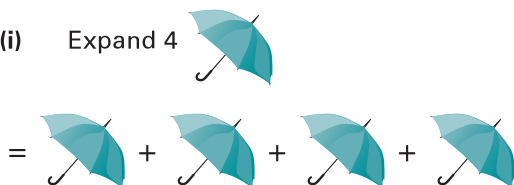

(ii) Expand 537

$$537 = 500 + 30 + 7$$

See expanded notation

## expanded notation

A way of writing numerals or algebraic expressions.

### Examples

(i)  $249 = 200 + 40 + 9$

or  $= (2 \times 100) + (4 \times 10) + (9 \times 1)$

or  $= 2 \times 10^2 + 4 \times 10^1 + 9 \times 10^0$

(ii) In algebra

$$2(a + 2b) = (2 \times a) + (2 \times 2b)$$

or  $= a + a + b + b + b + b$

See index notation, scientific notation

## exponent

A symbol indicating how many times the quantity is to be multiplied by itself to produce the power shown. Another word for index.

See base, index, index notation, power of a number

## expression

See algebraic expression

## exterior

The outside of something.

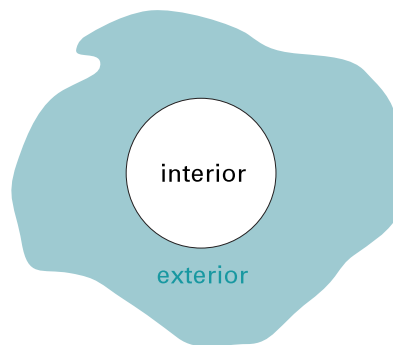

### Examples

(i) Exterior angle

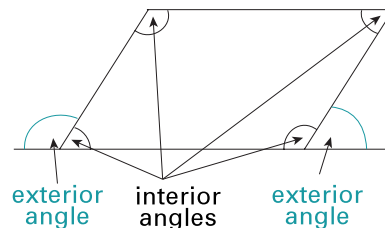

(ii) Exterior angle of a triangle

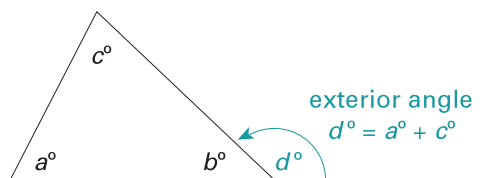

The exterior angle of a triangle is the sum of the two opposite interior angles.

See interior angles



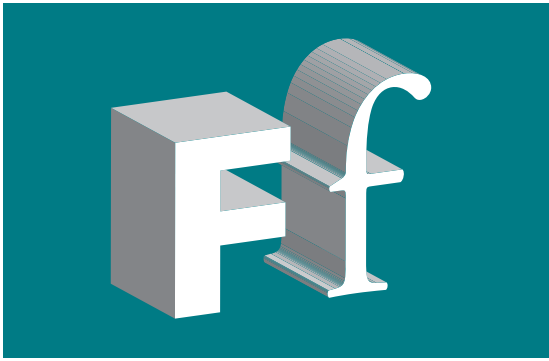

## face

In a three-dimensional shape, a face is the flat part of the surface that is bounded by the edges.

### Examples

- (i) A cube has six faces.

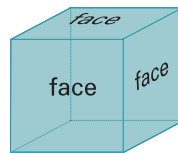

- (ii) A tetrahedron has four faces.

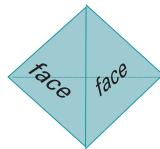

- (iii) A pyramid has five faces.

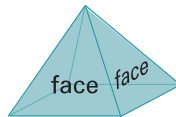

See cube, edge, pyramid, surface, tetrahedron, three-dimensional

## factorisation

We can simplify algebraic expressions by extracting a common factor.

### Example

Factorise  $3a + 6b$

$$\begin{aligned}
 & 3a + 6b \\
 = & \textcircled{3} \times a + 2 \times \textcircled{3} \times b \\
 & \swarrow \quad \searrow \\
 & \text{common factor} \\
 = & 3(a + 2b)
 \end{aligned}$$

See algebraic expression

## factors

All the whole numbers that can be divided exactly into another number.

### Examples

	factor
(i) $6 \div 1 = 6$	1
$6 \div 2 = 3$	2
$6 \div 3 = 2$	3
$6 \div 6 = 1$	6

1, 2, 3 and 6 are factors of 6.

(ii)  $5 \div 1 = 5$   
 $5 \div 5 = 1$

Prime number 5 has only the factors 5 and 1.

See composite number, factor tree, prime number, whole numbers

## factor tree

A diagram that shows the prime factors of a given number.

### Example

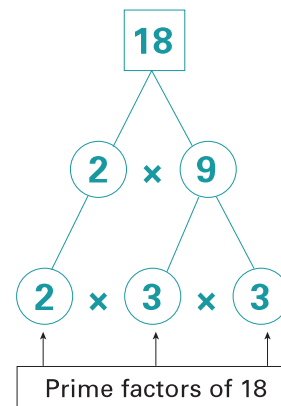

See prime factor of a number



## false sentence

A sentence about numbers that is not true.

### Examples

$5 < 1$  is a false sentence.

The open sentence  $3 + \square = 10$  becomes false if  $\square$  is replaced by any other number than 7, e.g. 3, 4, 5 ...

If  $\square$  is replaced by 7, it will become a true sentence.

See number sentence, true sentence

### Examples

- (i) The region inside a square is finite because it is bounded by a perimeter.
- (ii) The set of months in a year is a finite set because the months can be counted.

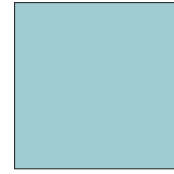

See infinite, perimeter, region, set

## first

The one at the beginning, before any other.

### Example

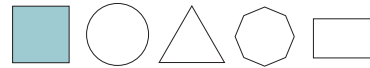

The first shape is a square.

## farthest

(furthest)

The longest distance away.

### Example

Name	Distance
Kate	3.50 m
Paul	3.89 m
Mike	3.47 m



Paul jumped the farthest.

See distance

## flat

- (i) Being in one plane only.

### Examples

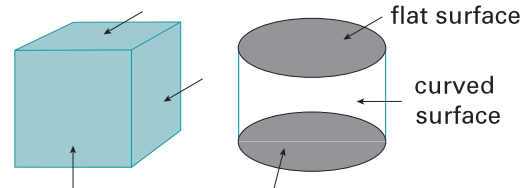

Every face of a cube is flat.

flat surface

- (ii) The name used for the multibase arithmetic block representing one hundred.

### Example

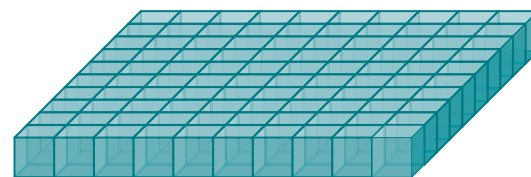

flat

See cube, face, multibase arithmetic blocks (MAB), plane, surface

## figure

Another name for a numeral, line, shape or a solid.

### Examples

- (i) Write in figures: thirty-six 36
- (ii) Half of this figure has been coloured in.

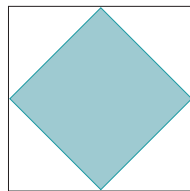

## finite

Anything that has boundaries or can be counted.

## flexible

A jointed structure is flexible when its angles can be changed by moving the struts without altering their size or arrangement.

### Example



A rectangle forms a flexible structure.

See rigid

## flip

To turn over.

### Example

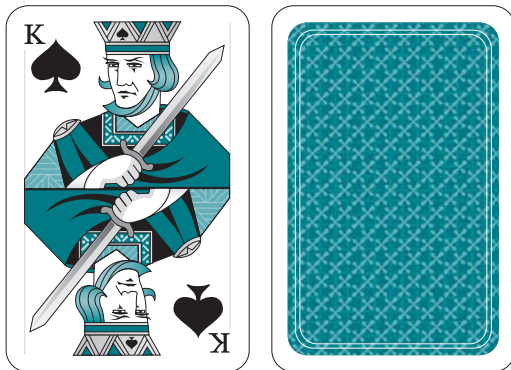

This playing card has been flipped over.

See reflection, slide, turn

## foot

(Plural: feet)

(Symbols: ', ft)

A measure of length.

1 foot  $\approx$  30 centimetres

1 foot = 12 inches

The altitude of an aeroplane or the depth of a submarine is measured in feet.

## formula

(Plural: formulae, formulas)

An equation that uses symbols to represent a statement.

### Example

$$A = lw$$

width  
 $w$

length  $l$

Statement: The area of a rectangle is found when its length is multiplied by its width.

See area, equation, symbol

## fortnight

Fourteen days or two weeks.

## fraction

A part of a whole quantity or number.

### Examples

- (i) The fraction  $\frac{3}{4}$  means 3 parts out of a total of 4 equal parts.

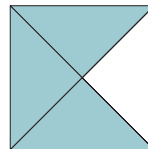

3 parts out of 4 parts are coloured.

- (ii) 7 parts out of 100 parts are coloured in.

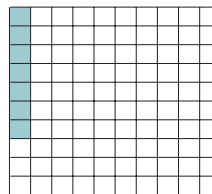

The fraction is  $\frac{7}{100}$

- (iii) Show  $\frac{3}{4}$  of 8.

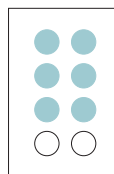

$$\frac{6}{8} = \frac{3}{4}$$

See cancelling, common denominator, decimal fraction, equivalent fractions, improper fraction, mixed number, proper fraction, simple fraction

## frequency

The frequency of any item in a collection of data is the number of times that item occurs in the collection.

### Example

We tossed a die 50 times and recorded the number for each throw. We kept a tally of the 50 scores.



Number	Tally	Frequency
1	HHH	7
2	HHH HHH	12
3	HHH	9
4	HHH	8
5	HHH	6
6	HHH	8

Number 2 had the highest frequency. Number 5 had the lowest frequency.

See data, frequency distribution, tally

## frequency distribution

A graph or table showing how often an event or quantity occurs.

### Example

A frequency distribution table of marks:

Mark	Tally	Frequency
20–29		1
30–39	HHH	5
40–49	HHH	9
50–59	HHH	8
60–69	HHH	5
70–79		3
80–89		1
	<b>Total</b>	32

## frequency table

See frequency distribution

## front view

A diagram of an object, as seen from directly in front of it.

### Example

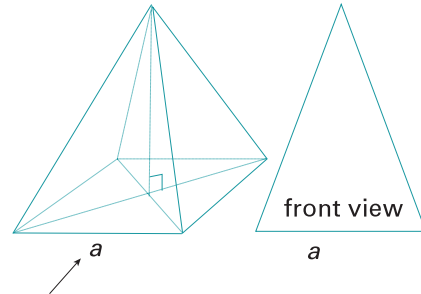

See plan, side view

## frustum

A pyramid cut by a plane parallel to the pyramid's base.

### Example

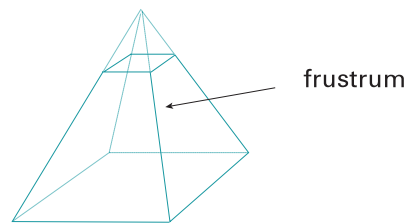

See decahedron, pyramid, section



## g

- (i) g is the symbol for the unit gram.
- (ii) It is also a symbol for gravity. The force of gravity on the Earth's surface is 1 g.

*See mass, weight*

## gallon

Measure of volume.

1 imperial gallon  $\approx$  4.5 litres

## geo-board

A board studded with nails forming a pattern or grid, usually of squares or equilateral triangles.

Geo-boards are used for shape and number activities in which elastic bands are arranged around sets of nails.

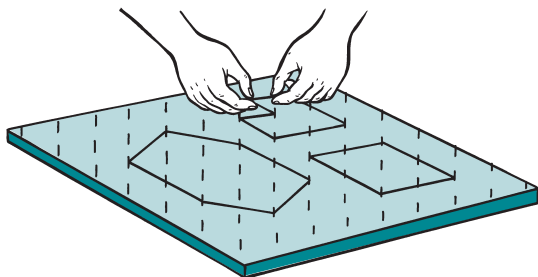

*See equilateral triangle, grid, pattern*

## geometric progression

*See progression*

## geometry

The part of mathematics that deals with the relationships, properties and measurements of solids, surfaces, lines, angles and space.

*See measure, property, solid, space, surface*

## geo-strips

Strips of plastic, metal or cardboard with holes equally spaced down the centre of the strips. They are used for making shapes.

*Examples*

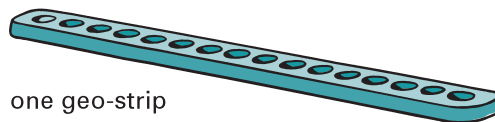

one geo-strip

Shapes made using geo-strips

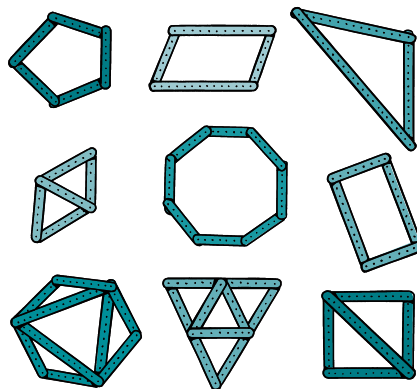

*See flexible, rigid*

## Goldbach's conjecture

Every even, natural number is equal to the sum of two prime numbers.

$$2 = 1 + 1 \quad 10 = 3 + 7$$

$$4 = 2 + 2 \quad 12 = 5 + 7 \text{ or } 1 + 11$$

$$6 = 3 + 3 \quad 24 = 11 + 13$$

$$8 = 1 + 7 \quad 42 = 19 + 23$$

*See natural number, prime number*



## googol

A very large number. It has the numeral 1 with one hundred zeros after it.

1 000 000 000 000 000 000 000 000 000  
000 000 000 000 000 000 000 000 000 0...

## gradient

Measurement of slope, inclination to horizontal base, or pitch. It can be measured and expressed as a ratio.

### Examples

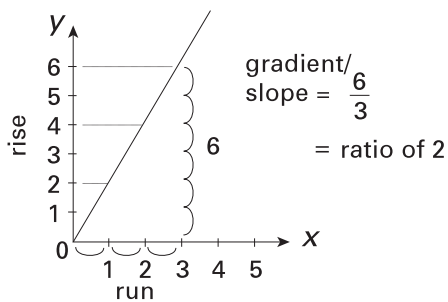
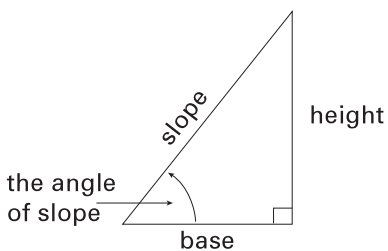

The ratio  $\frac{\text{height}}{\text{base}}$  or  $\frac{\text{rise}}{\text{run}}$  is called the slope, the gradient or the pitch.

See Pythagorus' theorem, tangent ratio

## graduated

Marked off with measurements.

### Examples

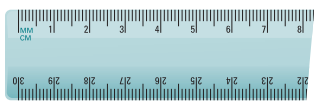

ruler

A ruler is graduated in centimetres.



thermometer

A thermometer is graduated in degrees.

## gram

(Symbol: g)

A unit of mass.

$$1000 \text{ g} = 1 \text{ kg}$$

### Examples



The mass of this box of chocolates is 250 grams.

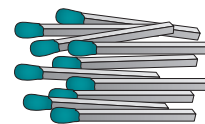

The mass of ten matches is approximately 1 gram.

See mass, unit of measurement

## graph

Drawings or diagrams which show information, usually about how many things.

There are different kinds of graphs.

### Examples

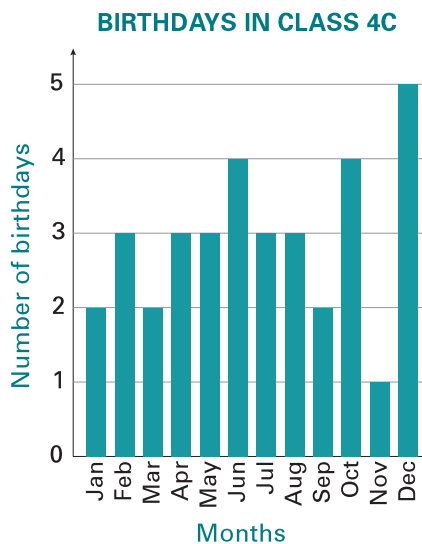

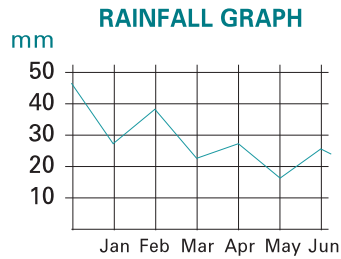

This is a line graph.

See axis, bar graph, column graph, line graph, pictograph, pie graph

## greater than

(Symbol: >)

A relation between a pair of numbers showing which is greater. More than. Bigger than.

*Example*

$$7 > 6$$

↑  
greater than

See less than

## grid

Regular lines that go across, up and down. Often found on maps and graphs.

*Examples*

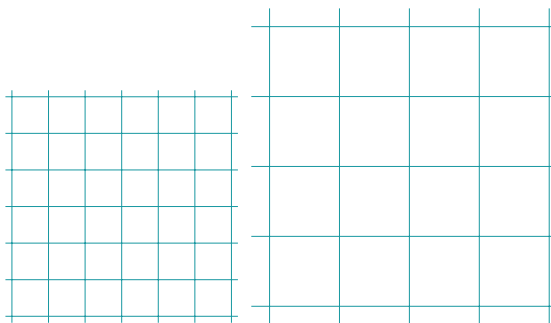

See isometric paper, square paper

## gross

Twelve dozen, 144.

## gross mass

The mass of an object together with its container.

*Example*

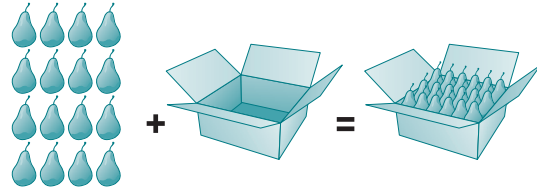

net mass + tare = gross mass

The actual mass of the object is called net mass. The mass of the packaging is called tare.

See mass



## group

- (i) Putting things together in a set or group. In the decimal system things are grouped into tens.

*Example*

Hundreds	Tens	Units
2	4	3

243 = 2 groups of 100  
4 groups of 10  
3 groups of 1

- (ii) Two or more things.

*Example*

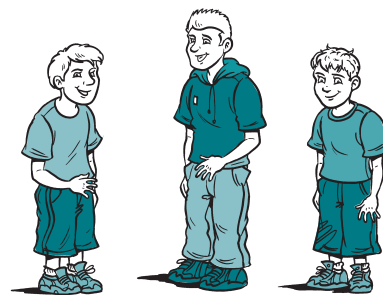

a group of boys

See grouping

---

## grouping

Putting things together into sets with the same number in each set.

### *Example*

How many groups of four can be made with twenty balls?

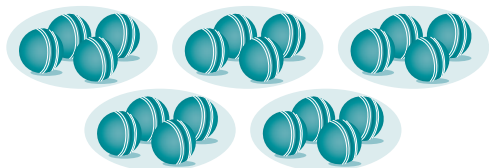

Answer: Twenty balls are put into five groups of four.

*See* division, set

---

## grouping symbols

*See* braces, brackets, order of operations, parentheses





## h

Symbol for height, hour, prefix hecto-.

## ha

A symbol for hectare.

## half

(Plural: halves)

One part of two equal parts.

### Examples

(i)

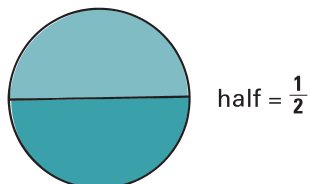

(ii) Half of twenty-four is twelve.

$$\frac{1}{2} \times 24 = 12$$

(iii) An orange has been cut into two halves.



## handspan

The distance from the top of the thumb to the top of the smallest finger when the hand is fully stretched.

### Example

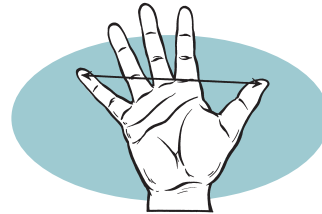

This is a handspan

A handspan is used as an arbitrary measure for estimating the lengths, heights or widths of objects.

See arbitrary unit, estimate



## hecta, hecto

Prefix that means 100.

See hectare

## hectare

(Symbol: ha)

A unit of area.

One hectare is the area of a square with sides measuring 100 metres.

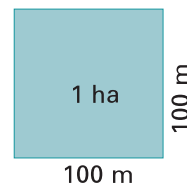

The area of a soccer field is approximately half a hectare.

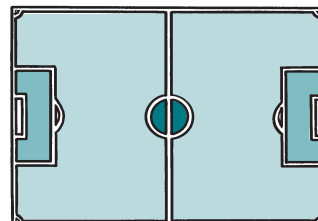

See area, unit of measurement

## heft

To judge the weight of objects by lifting them in the hands.

### Examples

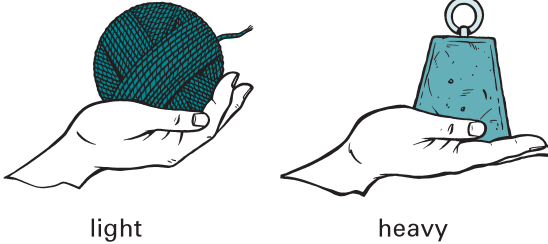

See weight

## height

Measurement from top to bottom, the vertical distance.

### Examples

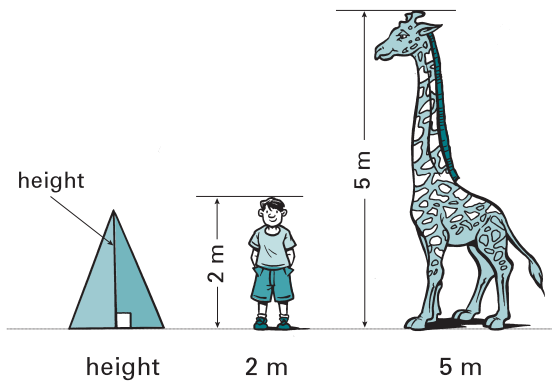

See altitude, vertical

## hemisphere

Half of a sphere.

### Example

Australia lies in the southern hemisphere.

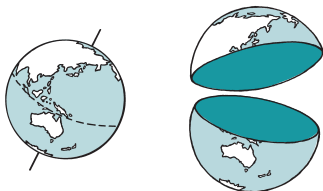

Each part is  $\frac{1}{2}$  of a sphere.

See sphere

## heptagon

A polygon with seven sides and seven angles. Regular heptagons have all sides congruent and all angles the same.

### Examples

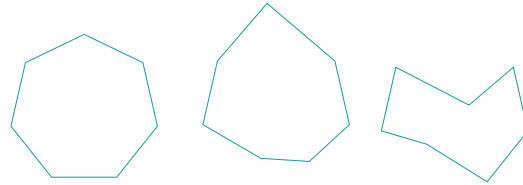

regular heptagon      irregular heptagons

See polygon

## hexagon

A shape (polygon) which has six sides and six angles.

### Examples

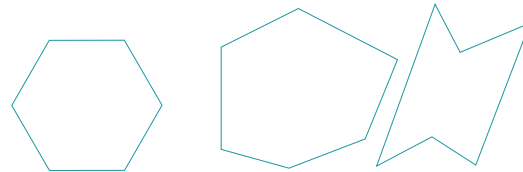

regular hexagon      irregular hexagons

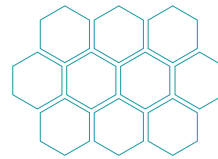

Honeycomb is made up of regular hexagons.

See polygon

## hexagram

A shape formed by two intersecting equilateral triangles.

### Example

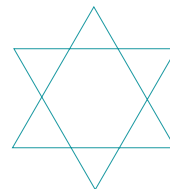

## hexahedron

A solid (polyhedron) with six faces. All cuboids are hexahedrons.

A cube is a regular hexahedron; all six faces are congruent squares, all internal angles are equal.

### Examples

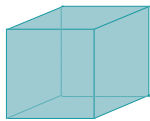

regular hexahedron

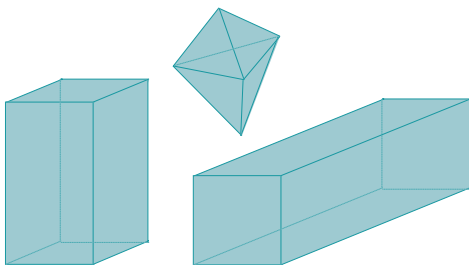

irregular hexahedron

See cube, cuboid, polyhedron, prism, regular polyhedron

## highest common factor

(HCF)

The largest number that divides into all given numbers.

### Example

For given numbers 8, 12, 16 and 20 the highest common factor (HCF) is 4.

See factors, factor tree

## Hindu–Arabic

Our modern system of numbers is the result of centuries of development.

The symbols for all the digits, except zero, probably originated with the Hindus in India, as early as 200 BC.

Hindu numerals



The Arabs adopted the system.

Arabic numerals (13th-century AD)



The numerals, including zero, were standardised after the invention of the printing press in the 15th century.

0 1 2 3 4 5 6 7 8 9

The modern system has very useful characteristics:

- (i) it has only ten digits: 0, 1, 2, 3, 4, 5, 6, 7, 8, 9
- (ii) it uses zero as a place holder
- (iii) it uses place value system: the value of the digit depends on its placement in the numeral:

37    307    13700

See numeral, place holder, place value

## histogram

A column graph with no spaces between columns.

### Example

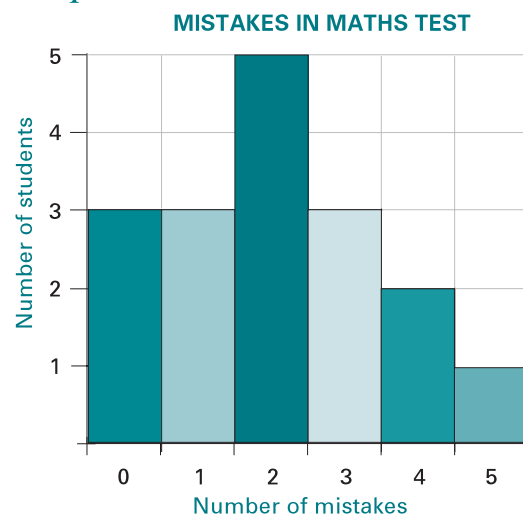

See column, column graph

## horizon

Line at which land and sky appear to meet.

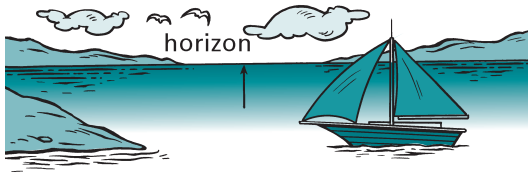

See horizontal line

## hour

(Symbol: h)

A unit of time.

$$1 \text{ hour} = 60 \text{ minutes}$$

$$1 \text{ hour} = 3600 \text{ seconds}$$

$$24 \text{ hours} = 1 \text{ day}$$

See unit of measurement

## hundred

$$100 = 10 \times 10 \text{ or } 10^2$$

See decimal place-value system

## hypotenuse

The longest side of a right-angled triangle, which is the side opposite the right angle.

*Example*

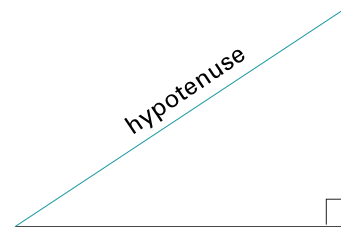

See Pythagoras' theorem, right-angled triangle

## horizontal line

Line parallel to, or on a level with, the horizon.

A vertical line is at right angles to the horizon.

*Example*

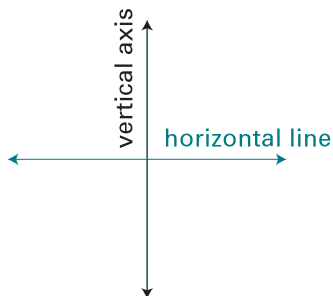

See axis, bar graph, base line, parallel lines, right angle, vertical

## horizontal surface

Any surface which is parallel to, or on a level with, the horizon.

*Example*

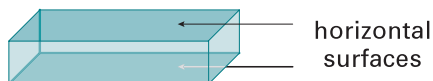

See horizon, parallel lines, surface



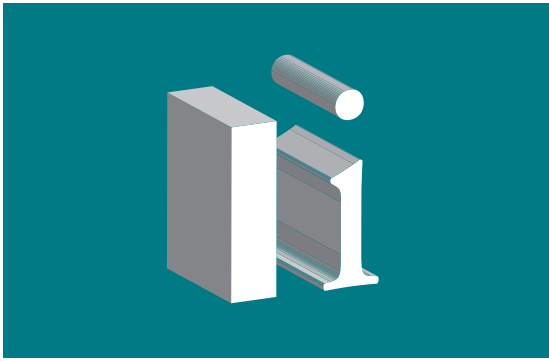

## icosahedron

A solid (polyhedron) with twenty faces.

A regular icosahedron is formed by joining together twenty congruent equilateral triangles.

*Example*

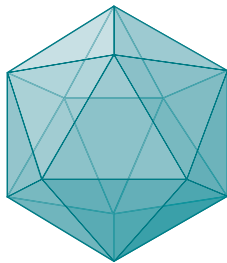

regular icosahedron

See polyhedron, regular polyhedron

## identical

Exactly alike.

*Examples*



5 5

## image

An exact copy of an object.

*Example*

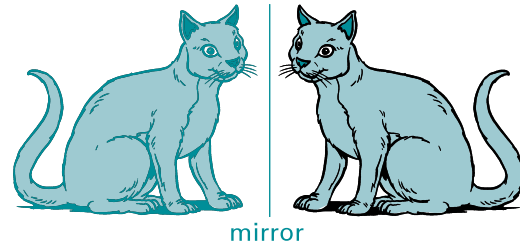

mirror

The image in a mirror

See mapping, mirror image, reflection

## improper fraction

A fraction whose numerator is greater than its denominator.

*Example*

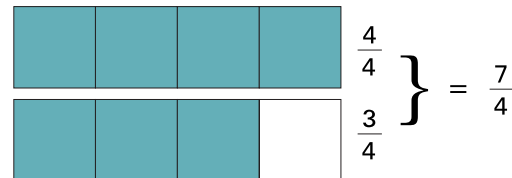

See denominator, fraction, mixed number, numerator, proper fraction

## inch

(Symbol: ", in)

A measure of length.

$$1 \text{ inch} = 2.54 \text{ cm}$$

$$12 \text{ inches} = 1 \text{ foot}$$

## increase

Make larger by adding a certain amount, or multiplying by a number.

*Examples*

- (i) The price of a three-dollar bus ticket has been increased by fifty cents.

$$\$3 + 50c = \$3.50$$

▣ **increase** *continued...*



- (ii) My family of 2 cats has increased 3 times. How many kittens do I have now?

$$2 \times 3 = 6$$

$$6 - 2 = 4$$

I have 4 kittens.

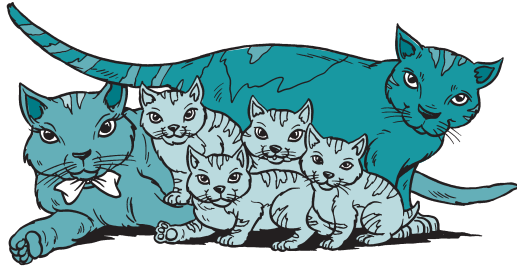

See decrease, progression

## index

(Plural: indices)

$$10^6$$

base                      index or exponent

Index is also called exponent.

In  ${}^3\sqrt{5}$  the index is 3. Where no index is written, as in  $\sqrt{5}$ , the index is 2.

See base, exponent, index notation, square root

## index laws

In algebra, when working with indices or algebraic expressions, these laws must be remembered:

*Law*

$$x^a \times x^b = x^{a+b}$$

$$\frac{x^a}{x^b} = x^{a-b}$$

$$x^0 = 1$$

$$(x^a)^b = x^{a \times b} = x^{ab}$$

$$(x \times y)^a = x^a y^a$$

$$\left(\frac{x}{y}\right)^a = \frac{x^a}{y^a}$$

$$x^{-a} = \frac{1}{x^a}$$

$${}^n\sqrt{a} = a^{\frac{1}{n}}$$

*Example*

$$5^3 \times 5^2 = 5^{3+2} = 5^5$$

$$\frac{5^3}{5^2} = 5^{3-2} = 5^1 = 5$$

$$5^0 = 1$$

$$(5^3)^2 = 5^{3 \times 2} = 5^6$$

$$(5 \times 4)^3 = 5^3 \times 4^3$$

$$\left(\frac{5}{4}\right)^3 = \frac{5^3}{4^3}$$

$$5^{-3} = \frac{1}{5^3}$$

$${}^3\sqrt{5} = 5^{\frac{1}{3}}$$

## index notation

A shorthand way of writing large numbers such as 1 000 000. Also called scientific notation.

*Example*

Using index notation:

$$1\,000\,000 = 10 \times 10 \times 10 \times 10 \times 10 \times 10 \times 10 = 10^6$$

$$10^6$$

base                      index or exponent

is read as:

'ten to the power of six' or

'ten to the sixth power'.

See base, cubed number, power of a number, scientific notation, square number

## inequality

A statement that one quantity is less than or greater than another.

The symbols  $<$ ,  $>$  and  $\neq$  are used to express inequalities.

### Examples

$5 \neq 6$  Five is not equal to 6.

$5 < 6$  Five is less than 6.

$6 > 4$  Six is greater than 4.

See equality, greater than, less than, not equal

## inequality signs

SIGN MEANING

$<$	less than
$\leq$	less than or equal to
$\neq$	not equal to
$>$	greater than
$\geq$	greater than or equal to

## inequation

A statement that two quantities are not equal.

### Example

$$x + \underset{-5}{5} > \underset{-5}{7}$$

$$x > 2$$

This inequation is true for any number greater than 2, for example 3, because  $3 + 5 = 8$ , which is greater than 7.

See equality, equation, inequality

## infer

Make a predictive statement or conclusion, based on observation or reasoning.

See prediction

## infinite

Without bounds of size or number, unlimited, not finite, endless.

### Example

{Whole numbers} is an infinite set.

See finite, set, whole numbers

## infinite decimal

(not terminating)

Decimals which go on without end.

### Example

$$\pi = 3.1415927\dots$$

See recurring decimal, terminating decimal



## infinity

(Symbol:  $\infty$ )

Expressing quantity without bounds.

See infinite

## input

See number machine

## insignificant zeros

Unnecessary zeros in decimal numbers.

### Examples

wrong	correct
05.2	5.2
9.980	9.98
.25	0.25

## integers

Positive or negative whole numbers including zero.

### Examples

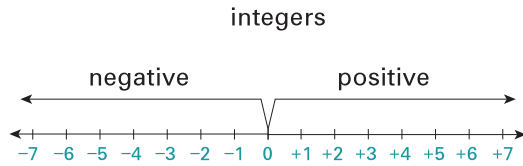

The set of integers:

$\{-6, -5, -4, -3, -2, -1, 0, 1, 2, 3, 4, 5, \dots\}$

See directed numbers, negative numbers, positive numbers, set, whole number

## interest

Price that is charged or paid for the use of money.

### Examples

- (i) The bank pays interest to a person who puts money into a savings account, as the bank can use that money to lend it to someone else.
- (ii) People who borrow money from a bank have to pay the bank interest on the amount borrowed, in return for using the bank's money.

See interest rate, principal

## interest rate

The interest rate is a rate that is charged or paid for the use of money. It is often expressed as an annual percentage of the principal.

### Examples

- (i) Joshua borrows \$100 from a bank at a rate of interest of 10 per cent per annum.  
The interest Joshua has to pay after a year is 10% of \$100, which is  $\frac{10}{100} \times \$100 = \$10$
- (ii) Oliver puts \$100 into his savings account. The interest rate the bank pays on savings accounts is 6% annually.  
Oliver receives 6% of \$100, which is  $\frac{6}{100} \times \$100 = \$6$

See annual, interest, principal

## intercept

When drawing graphs of equations, an intercept is the point where the equation line crosses an axis.

### Example

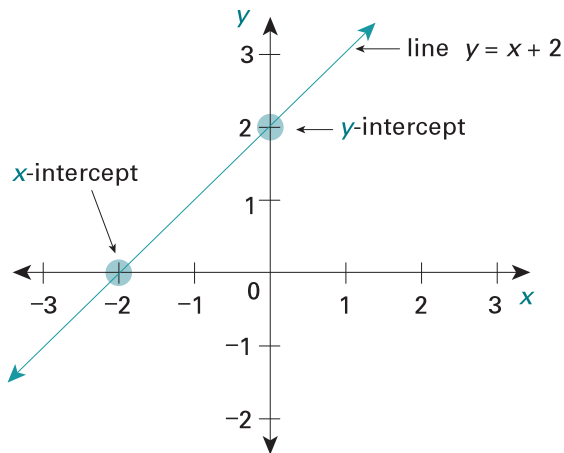

The line  $y = x + 2$  crosses the  $y$ -axis at point  $(0, 2)$ . The point  $(0, 2)$  is called the  $y$ -intercept.

The line also crosses the  $x$ -axis at point  $(-2, 0)$ , which is called the  $x$ -intercept.

See coordinates, gradient

## interior

The inside of something.

See exterior



## interior angles

Angles inside a shape.

### Example

The sum of interior angles inside any triangle is  $180^\circ$ .

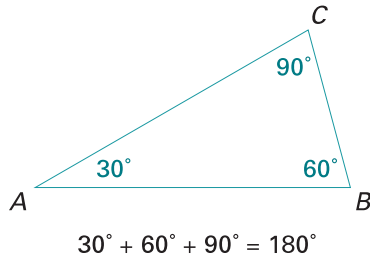

See exterior

## intersect

To cut across. To cross each other.

### Example

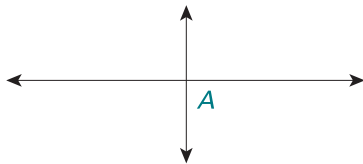

The two lines intersect at point A.

## intersection

- (i) The place where two or more lines meet, like an intersection of two streets.

### Example

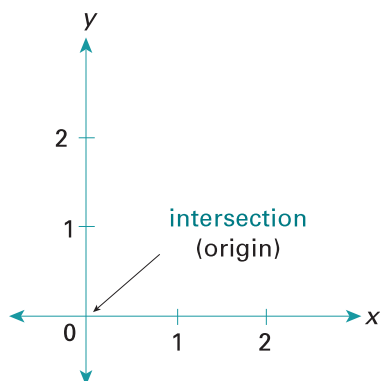

- (ii) The region where shapes overlap.

### Example

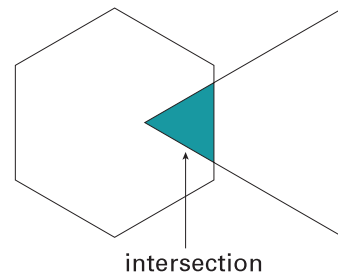

- (iii) (Of sets) The set of elements that are common to both sets.

### Example

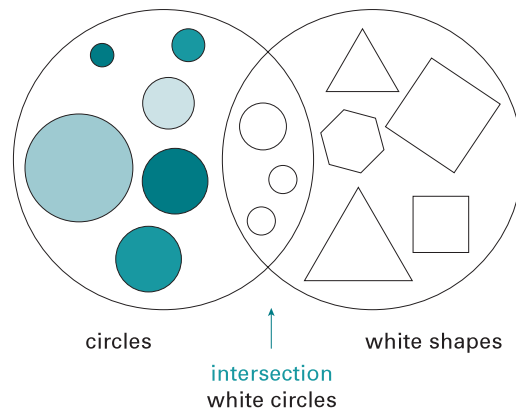

See coordinates, origin, region, set, shape

## interval

The amount of time, or distance, between two events or places.

### Examples

- (i) There is a twenty-minute interval between the two films.  
 (ii) Line segment



See line

## inverse

Inverted in position, order or relation. When one quantity increases, the other decreases at the same rate.

See additive inverse, invert, proportion, ratio

## inverse factor tree

A diagram that shows prime numbers and the number they belong to.

*Example*

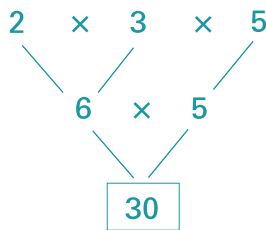

Prime numbers: 2, 3 and 5 have a product of 30.

See factor tree, prime factor of a number

## inverse operations

The operation which reverses the action of the original operation.

*Examples*

The operations

$$4 + 3 = 7 \text{ and}$$

$$7 - 3 = 4$$

are the inverse of one another.

The operations

$$6 \times 3 = 18 \text{ and}$$

$$18 \div 3 = 6$$

are the inverse of one another.

See operation, reciprocal

## invert

Turn upside down, reverse position.

*Examples*

$$\frac{1}{2} \text{ inverts to } \frac{2}{1} \text{ or } 2$$

$$\frac{3}{4} \text{ inverts to } \frac{4}{3} \text{ or } 1\frac{1}{3}$$

## irrational number

Number that cannot be written as an integer or ratio.

*Examples*

$$\pi \quad \sqrt{2} \quad \sqrt{3} \quad \sqrt[3]{2}$$

See rational number, real number

## irregular polygon

A shape in which not all sides are equal in length, and/or at least one angle is different in size from the other angles.

*Examples*

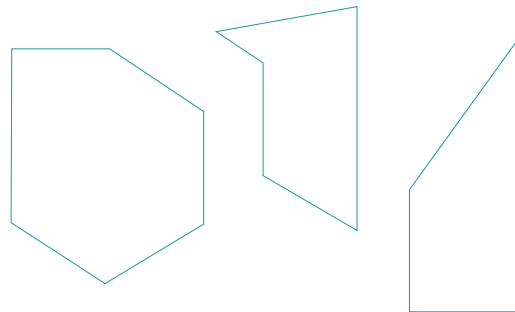

See polygon, regular polygon

## isometric drawing

A drawing where the three dimensions are represented by three sets of lines  $120^\circ$  apart, and all measurements are in the same scale (not in perspective).

*Example*

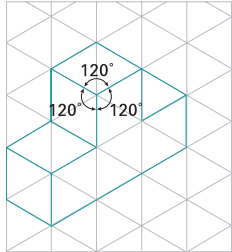

*See perspective*

## isometric paper

Paper with dots or lines that make equilateral triangles. Used for isometric drawings.

*Example*

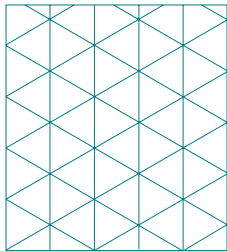

*See dot paper, equilateral triangle, square paper*

## isosceles triangle

A triangle in which two sides have the same length and two angles have the same size.

*Examples*

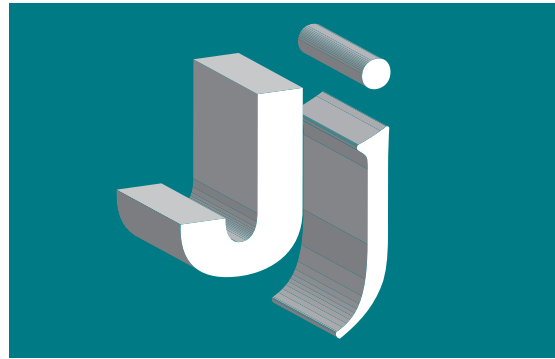
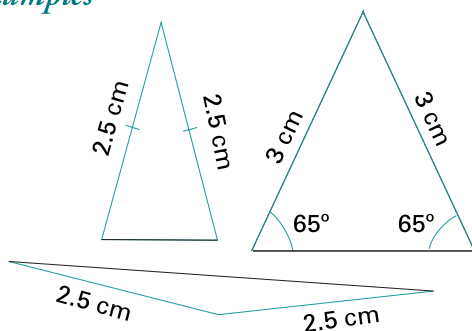

## jigsaw

A puzzle in which pieces fit together to form a picture.

*Example*

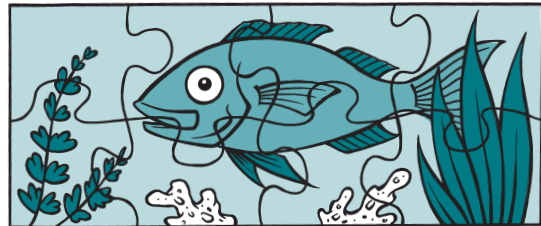

## joule

Unit of energy or work. It replaces the old unit, calorie.

*See kilojoule*



## kilogram

(Symbol: kg)

The base unit of mass.

$$1 \text{ kg} = 1000 \text{ g}$$

### Examples

The mass of this packet of sugar is 1 kilogram.



The mass of this girl is 27 kilograms.



See gram, mass, unit of measurement

## kilojoule

(Symbol: kJ)

Used for measuring energy or work.

$$1 \text{ kilojoule} = 1000 \text{ joules}$$

### Example

A piece of chocolate cake has 2000 kilojoules.

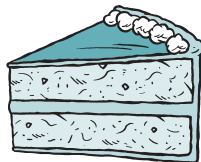

## kilolitre

(Symbol: kL)

A unit of volume (capacity) for measuring liquids.

$$1 \text{ kL} = 1000 \text{ L}$$

### Example

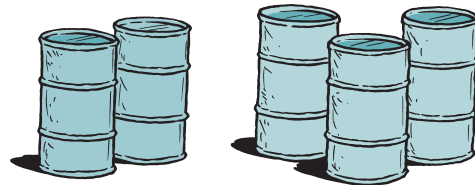

Five 200-litre oil drums hold one kilolitre.

See capacity, unit of measurement, volume

## kilometre

(Symbol: km)

A unit of distance. Distances between towns are measured in kilometres.

$$1 \text{ km} = 1000 \text{ m}$$

### Example

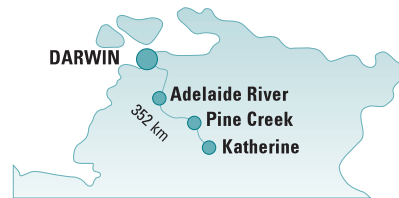

The road distance from Darwin to Katherine is 352 kilometres.

See distance, unit of measurement

---

## kite

A quadrilateral that is shaped like this.

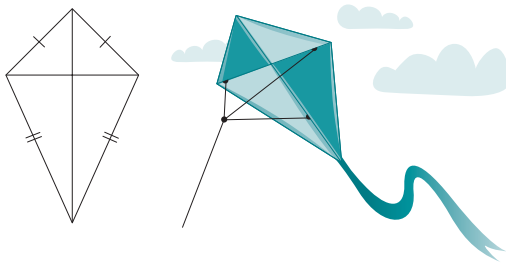

The two short sides are equal in length.

The two long sides are equal in length.

The diagonals are perpendicular to each other.

*See quadrilateral*

---

## knot

(Symbol: kn)

Measure of speed at sea and in aviation, equal to travelling one nautical mile per hour.

1 nautical mile = 1.852 kilometres

*Example*

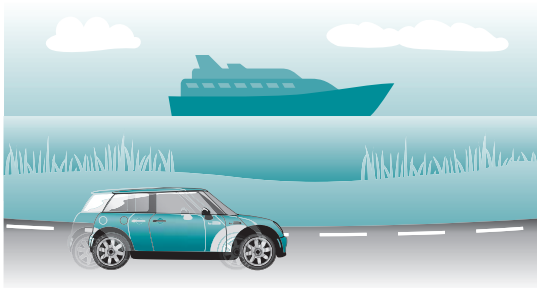

A ship moving at 20 knots is travelling as fast as a vehicle on land travelling about 37 kilometres per hour.

*See speed*



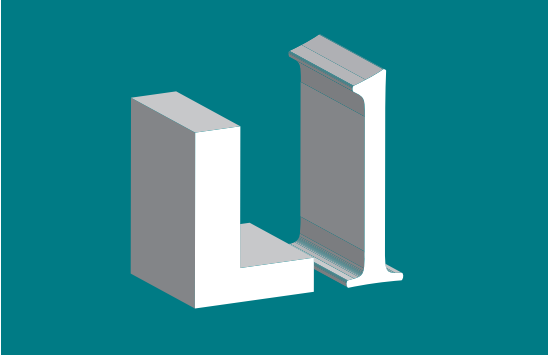

## L

- (i) L is the symbol for litre.
- (ii) In Roman numerals L stands for fifty.

See capacity, litre

## lateral

See equilateral

## LCD

See lowest common denominator

## LCM

See lowest common multiple

## leap year

A year which has 366 days instead of 365 days. It occurs every four years.

In a leap year February has twenty-nine days instead of twenty-eight days.

When the year number can be divided by 4 leaving no remainder, then it is a leap year.

### Example

$$1979 \div 4 = 494 \text{ (r3)}$$

This is not a leap year.

$$2012 \div 4 = 503$$

This is a leap year.

Century years are not leap years unless they are divisible by 400.

### Example

1600, 2000, 2400 are leap years.

1500, 1700, 1800 are not leap years.

## least

The smallest thing or amount in a group.

### Example

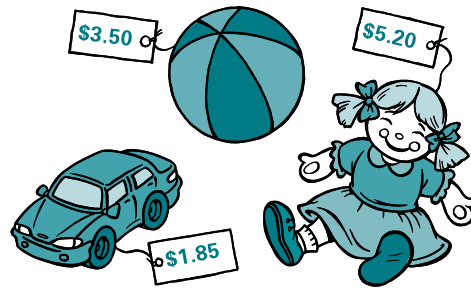

The toy car costs the least amount.

## length

How long something is from end to end.

- (i) The measure of distance.

### Examples

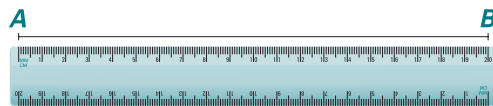

This ruler is 20 centimetres long.

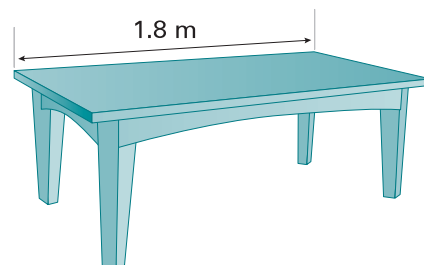

The length of this table is 1.8 metres.

Units of length are:

millimetre	mm
centimetre	cm
metre	m
kilometre	km

(ii) An interval of time.

### Example

How long is the lunchtime break?

See centimetre, distance, interval, kilometre, metre, millimetre

## less than

(Symbol: <)

A relation between pairs of numbers showing which is smaller.

### Example

$$5 < 7$$

↑  
less than

See greater than, inequality signs

## like terms

Similar, resembling each other.

In algebra, expressions are called like terms if they have the same variable and power. Like terms can be added and subtracted; terms that are not like cannot.

### Examples

Like terms

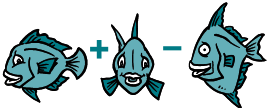
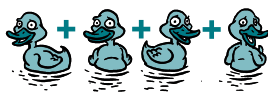

$$4x - 3x$$

$$5x^2y + x^2y$$

Unlike terms

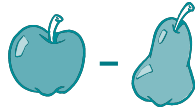

$$a - b$$

$$3x^2 + 3$$

See power of a number, unlike terms, variable

## line

A long thin mark drawn on a surface. It can be straight or curved. It has no thickness and has only one dimension. A straight line extends without end in both directions.



A straight line is the shortest possible distance between two points.

### Example



The line between  $A$  and  $B$  is the shortest distance between  $A$  and  $B$ . The arrowheads indicate that the line does not end where we stop drawing it. The interval  $AB$  has a finite length.

See curve, horizontal line, infinite, interval, line segment, vertical

## linear

Involving measurement in one dimension only.

See line



## linear equation

An equation that can be presented as a straight line.

### Examples

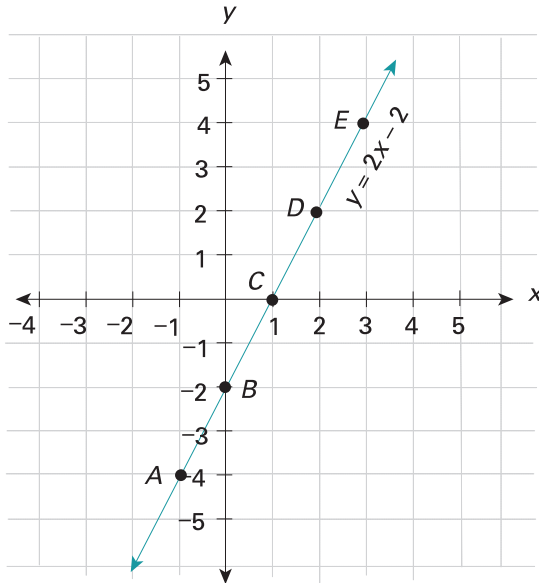

	A	B	C	D	E
x	-1	0	1	2	3
y	-4	-2	0	2	4

$$y = 2x - 2$$

See equation

## line graph

A graph formed by segments of straight lines that join the points representing certain data.

### Example

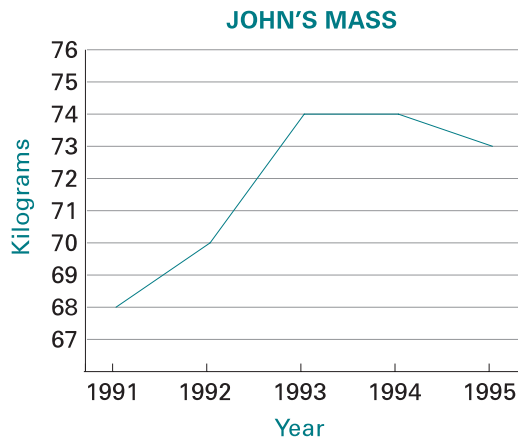

See graph, line, line segment

## line of symmetry

The line which divides something in half so that one half is the mirror image of the other half. This line is sometimes called an axis of symmetry.

A shape may have more than one line of symmetry.

### Examples

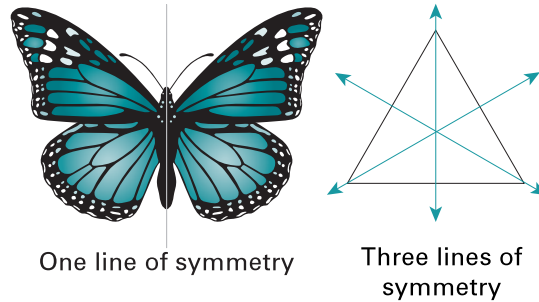

One line of symmetry

Three lines of symmetry

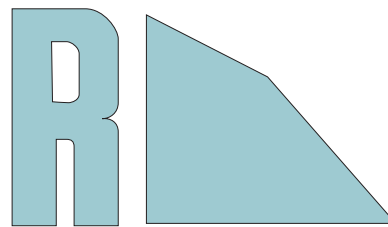

Some shapes have no line of symmetry.

See asymmetry, axis, symmetry

## line segment

Part of a straight line.

### Example

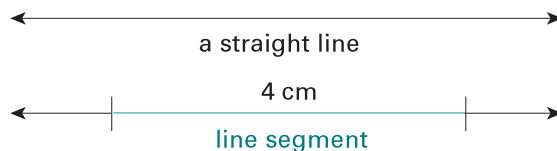

See diameter, line



## litre

(Symbol: L)

A unit of capacity used to measure the volume of liquids or the capacity of containers.

$$1 \text{ L} = 1000 \text{ cm}^3 = 1000 \text{ mL}$$

$$1000 \text{ L} = 1 \text{ kL}$$

### Example



A carton of milk holds one litre.

See capacity, unit of measurement, volume

## loss

If the selling price is lower than the cost price, the seller makes a loss.

### Example

A car dealer buys a car for \$10 000 and sells the same car for \$9000. As the selling price of the car is less than the buying price, the dealer suffers a loss of \$1000.

See cost price, profit, selling price

## lowest common denominator

(LCD)

The lowest counting number that is divisible by the denominators of given fractions.

The lowest multiple of two or more denominators.

### Example

What is the LCD of fractions  $\frac{1}{4}$  and  $\frac{1}{10}$ ?

4 divides exactly into } 4, 8, 12, 16, **20**, 24,  
(Multiples of 4 are) } 28, 32, 36, **40**, 44 ...

10 divides exactly into } 10, **20**, 30, **40**, 50,  
(Multiples of 10 are) } 60, 70 ...

The lowest number into which 4 and 10 divide exactly is 20.

Therefore 20 is the LCD.

Lowest common denominators are used in addition and subtraction of fractions.

### Example

$$\frac{1}{4} + \frac{1}{10} = \frac{5+2}{20} = \frac{7}{20}$$

See common denominator, counting number, denominator, fraction, lowest common multiple

## lowest common multiple

(LCM)

The lowest counting number that is a multiple of given numbers.

### Example

What is the LCM of 2 and 3?

The multiples of 2 are:

2, 4, **6**, 8, 10, **12**, 14, 16, **18** ...

The multiples of 3 are:

3, **6**, 9, **12**, 15, **18**, 21, ...

Common multiples are: 6, 12, 18...

The lowest common multiple of 2 and 3 is 6.

See counting number, multiple





## m

- (i) m is the symbol for metre.
- (ii) m is also the symbol for prefix milli-.

## M

- (i) M is the symbol for prefix mega-.
- (ii) In Roman numerals M means 1000.

## M

### MAB

See multibase arithmetic blocks

## magic square

A puzzle where the numbers are arranged in a square so that each row, column and diagonal add up to the same total.

*Example*

9	2	7	18
4	6	8	18
5	10	3	18
18	18	18	18

## magnitude

The size, or how big something is.

*Example*

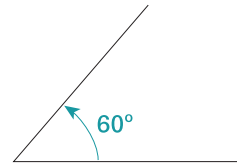

The magnitude of this angle is  $60^\circ$ .

See directed numbers

## many-to-one correspondence

A match between members of two sets in which more than one element of the first set is associated with one element of the second. Arrows are used to show the relationship.

*Example*

Children and their favourite drinks

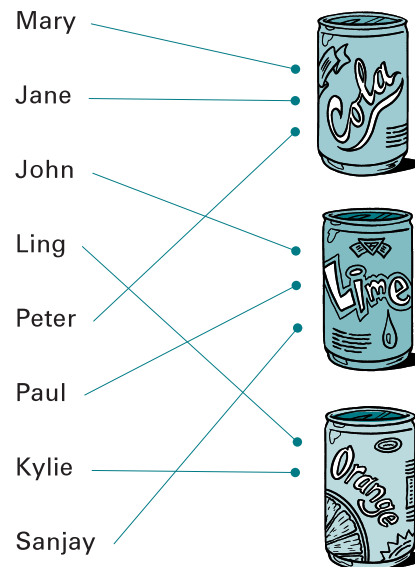

Three elements (Mary, Jane and Peter) of the first set are associated with one element (Cola) of the second set.

See arrow diagram, one-to-one correspondence

## mapping

A matching operation between two sets in which each member of the first set is assigned only one member of the second set as a partner or image.

### Example

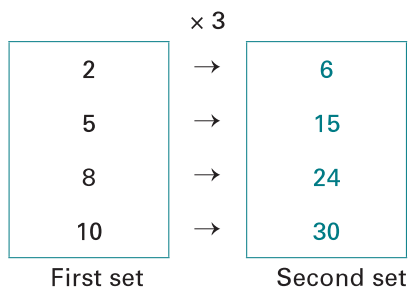

In the above example, 2 maps onto 6, so 6 is the image of 2.

*See image, many-to-one correspondence, one-to-one correspondence, set*

## mass

The amount of matter contained in an object.

Units of mass:

gram	g
kilogram	kg
tonne	t
1000 g	= 1 kg
1000 kg	= 1 t

### Example

This boy has a mass of 28 kilograms.



The word 'weight' is commonly but incorrectly used instead of mass.

*See beam balance, unit of measurement, weight*

## matching

*See many-to-one correspondence, one-to-one correspondence*

## mathematical shorthand

Instead of long sentences, mathematics uses numbers, symbols, formulas and diagrams.

### Example

The sentence, 'The area of a triangle is found when its base is multiplied by its perpendicular height and then divided by two,' is written in mathematical shorthand as:

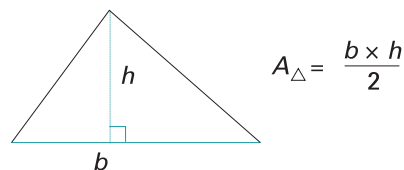

*See formula*

## maximum

The greatest or biggest value.

### Examples

- (i) The maximum temperature this month was 39° C.



- (ii) The maximum speed is 110 kilometres per hour.



*See minimum*

## maze

A kind of puzzle in which a person has to find a way through a network of lines, paths, etc.

### Example

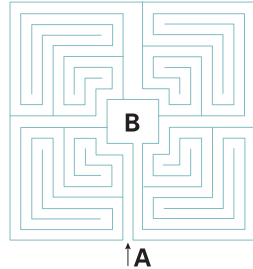

Follow the path from A to B without crossing any lines.

## mean

The mean is the average of a set of scores. It is found by adding up all scores and dividing the sum by the number of scores.

$$\text{Mean} = \frac{\text{sum of scores}}{\text{number of scores}}$$

See average, measures of central tendency

## measure

(i) Find out the size of something.

### Examples

How long? How tall? How heavy? How hot?

(ii) Compare quantities. A number assigned to a quantity which indicates its size compared to a chosen unit.

### Example

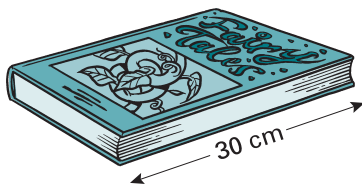

The length of the book is thirty centimetres.

See unit of measurement

## measures of central tendency

The three measures of central tendency are: mode, median and mean. They usually lie about the middle of the distribution and tell us certain facts about it.

See mean, median, mode

## median

In statistics, median is the middle measurement or score, when items are arranged in order of size.

### Example

Scores: 2, 2, 4, 5, 6, 8, 10

↑  
median = 5

Where there is no middle score, an average of the two central scores is taken.

### Example

Scores: 2, 3, 4, 8, 9, 10

↑ ↑  
median =  $\frac{4+8}{2} = 6$

See average, mean, measurements of central tendency, mode, score

## mega

(Symbol: M)

Prefix meaning one million times.

See megalitre



## megalitre

(Symbol: ML)

A unit of capacity.

$$1 \text{ megalitre} = 1\,000\,000 \text{ litres}$$

$$1 \text{ ML} = 1\,000\,000 \text{ L}$$

### Example

Volume (capacity) of this swimming pool is:

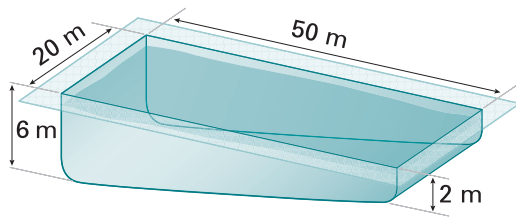

$$\text{Volume} = [50 \times 20 \times (6-2)] \text{ m}^3$$

$$= 4000 \text{ m}^3$$

$$= 4\,000\,000 \text{ L}$$

$$= 4 \text{ ML}$$

This swimming pool contains four megalitres (4 ML) of water.

*See* Decimal system prefixes on page 153

## mensuration

The branch of mathematics concerned with the measurement of lengths, areas and volumes.

## metre

(Symbol: m)

The base unit of length (distance).

$$1 \text{ m} = 100 \text{ cm}$$

$$1 \text{ m} = 1000 \text{ mm}$$

### Example

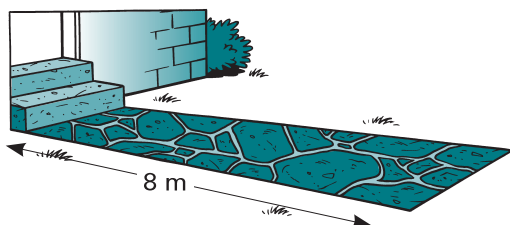

The path is eight metres long.

*See* distance, unit

## metric system

A decimal system of weights and measures.

The base unit for length is metre, for mass is kilogram, and for time is second.

*See* decimal system, SI, unit of measurement

## midpoint

A point in the middle of an interval.

### Example

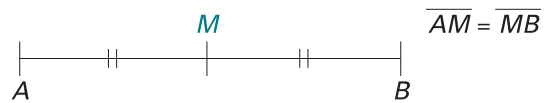

The point  $M$  is the midpoint of the interval  $AB$ .

*See* bisect, bisector

## mile

An imperial measure of length.

$$1 \text{ mile} \approx 1.6 \text{ km}$$

## mileage

The distance travelled during which the car uses a certain amount of petrol. It used to mean miles per gallon of petrol. It now means the number of kilometres per litre of petrol, or consumption of petrol per 100 kilometres.

*See* gallon, mile

## milli

(Symbol: m)

Prefix meaning one-thousandth.

*See* milligram, millilitre



**milligram**

(Symbol: mg)

A very small unit of mass, used when working with medicines and chemicals. It is one-thousandth of a gram.

$$1 \text{ mg} = \frac{1}{1000} \text{ g}$$

$$1 \text{ mg} = 0.001 \text{ g}$$

*See* gram**millilitre**

(Symbol: mL)

A unit of capacity.

$$1000 \text{ mL} = 1 \text{ L}$$

Note: One millilitre of water at 4°C has a mass of one gram.

*Examples*

a teaspoon holds 5 mL

*See* centimetre, volume

a bucket holds 9 L

**millimetre**

(Symbol: mm)

A unit of length.

$$10 \text{ mm} = 1 \text{ cm}$$

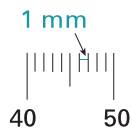
*Examples**See* centimetre, length**million**

One thousand thousands: 1 000 000.

*See* billion**minimum**

The smallest or least value.

*Example*

The minimum temperature in July was 4° C.

*See* maximum**minuend**

A number from which another number is to be subtracted.

*Example*

$$\begin{array}{r} 29 \\ - 7 \\ \hline 22 \end{array}$$

minuend    subtrahend    difference

29 is the minuend.

*See* difference, subtract, subtrahend**minus**

(Symbol: −)

(i) Subtract or take away.

*Example*

Eight minus two is written as 8 − 2 and means two subtracted from eight.

$$8 - 2 = 6$$

(ii) A symbol to mark negative numbers.

*Example*

$$-1, -2, -3, -4 \dots$$

*See* integers, negative numbers, subtract**minute**

(Symbol: min ')

(i) A measure of time.

$$\text{one minute} = \text{sixty seconds}$$

$$1 \text{ min} = 60 \text{ s}$$

There are sixty minutes in one hour.

(ii) Angle measurement.

$$1' (\text{min}) = \frac{1}{60} (\text{degree})$$

$$1^\circ (\text{degree}) = 60'$$

## mirror image

A reflection, as in a mirror.



See image, reflection

## mixed number

A whole number and a fraction.

*Examples*

$$1\frac{1}{2} \quad 3\frac{5}{2}$$

This is another way of writing an improper fraction:

$$\frac{3}{2} = 1\frac{1}{2} \quad \frac{35}{30} = 1\frac{5}{30} = 1\frac{1}{6}$$

See fraction, improper fraction, whole numbers

## möbius strip

(moebius)

A surface with only one side. It is made by giving a strip of paper or any other flexible material a half twist and then fastening the ends together.

If a line is drawn down the middle of the strip, it will come back to the starting point, having covered both sides of the strip, without the pencil being lifted.

*Example*



A thin strip of paper ...



can be given a twist ...



and have the ends ...



joined to make a möbius strip.

## mode

In statistics, the score that occurs most often in a collection.

*Example*

In scores,

1, 1, 2, 4, 4, 6, 6, 6, 6, 7, 7, 7, 8, 10,

6 is the mode.

See average, mean, measures of central tendency, median

## model

A three-dimensional representation of an actual or designed object. It may be a physical structure, for example, a model of a cube made from cardboard.

*Examples*

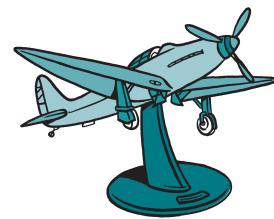
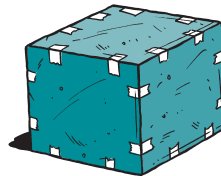

a model of a cube

a model of an aeroplane

See cube, net, scale drawing, three-dimensional

## month

A measure of time. There are twelve months in a year. The lengths of different months vary from twenty-eight to thirty-one days.

An easy way to remember the number of days in each month is to learn the following rhyme.

Thirty days has September,  
April, June and November.  
All the rest have thirty-one,  
Except for February alone,  
Which has but twenty-eight days clear,  
And twenty-nine in each leap year.

See calendar, day, leap year, year

**more**

Greater in amount.

*Example*

Four dollars is more than three dollars.

**most**

The greatest amount.

*Example*



Jim has twenty cents.

Betty has thirty-five cents.

Peter has thirty cents.

Betty has the most.

A set of base ten blocks consists of:

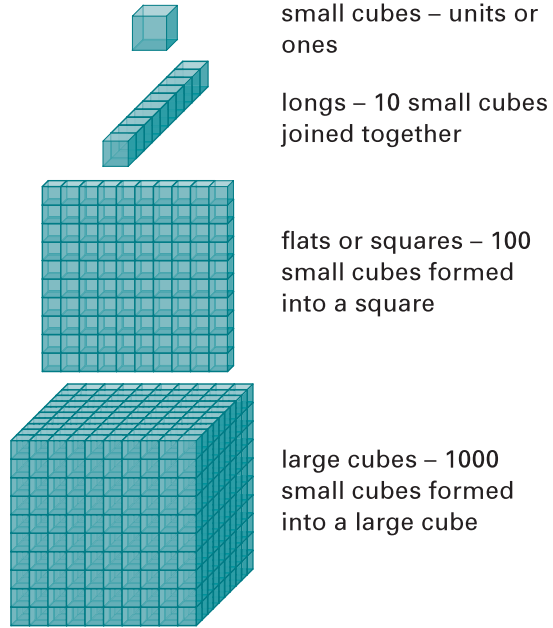

small cubes – units or ones

longs – 10 small cubes joined together

flats or squares – 100 small cubes formed into a square

large cubes – 1000 small cubes formed into a large cube

*See base*

**multilateral**

Having many sides.

**multiple**

A multiple of a given number is any number into which it will divide exactly.

*Examples*

Multiples of two are 2, 4, 6, 8, 10, 12 ...

Multiples of three are 3, 6, 9, 12, 15, 18 ...

Multiples of four are 4, 8, 12, 16, 20, 24 ...

*See division, lowest common multiple*

**multiplicand**

The number that is to be multiplied.

*Example*

$$\begin{array}{ccccccc} 8 & \times & 7 & = & 56 \\ \uparrow & & \uparrow & & \uparrow \end{array}$$

multiplicand multiplier product

*See multiplication, multiplier, product*



**multibase arithmetic blocks (MAB)**

A set of wooden blocks used to give a concrete representation of numbers. They can be used for any base.

*Example*

Base 3 blocks

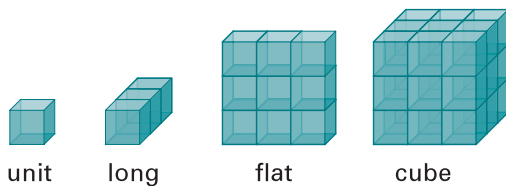

The most commonly used MAB blocks are the base ten blocks.



## multiplication

(Symbol:  $\times$ )

Multiplication is repeated addition.

*Example*



- (i) 2 groups of 3,  $2 \times 3 = 6$  or
- (ii) 3 multiplied by 2,  $3 \times 2 = 6$  or
- (iii) 3 made 2 times bigger.

Sign  $\times$  refers to two operations:

- (i) lots of or groups of, and
- (ii) multiplied by.

*See addition, operation*

## multiplication facts

*See table*

## multiplication property of one

When a number is multiplied by one, the product is equal to the original number. This is the multiplication property of one.

*Examples*

$$7 \times 1 = 7$$

$$1 \times 138 = 138$$

Use of the property is made when a fraction is converted to an equivalent form.

*Example*

$$\begin{aligned} \frac{2}{3} &= \frac{\square}{12} \\ \frac{2}{3} \times 1 &= \frac{2}{3} \times \frac{4}{4} \\ &= \frac{8}{12} \end{aligned}$$

$\frac{2}{3}$  has been multiplied by one  
(or by  $\frac{4}{4}$ , which is equal to one)

*See equivalent fractions*

## multiplier

The number by which another number is multiplied.

*Example*

$$\begin{array}{ccccccc} 5 & \times & 7 & = & 35 \\ \uparrow & & \uparrow & & \uparrow \end{array}$$

multiplicand multiplier product

*See multiplicand, multiplication, product*

## multiply

Carry out the process of repeated addition or multiplication.

*See addition, multiplication*



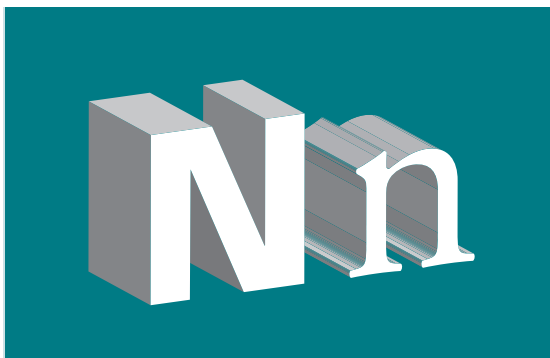

## natural number

One of the counting numbers.

### Examples

1, 2, 3, 4, 5, 6, 7, 8, 9 ...

See counting number, positive numbers

## nautical mile

Unit of length. Used for aviation and maritime purposes. A nautical mile is based on the circumference of the Earth.

One nautical mile equals 1852 metres or 1.852 kilometres.

See knot

## negative numbers

A negative number is a number less than zero. Negative numbers are written with the minus sign (-) in front of them.

### Examples

-0.1, -0.2, ... -0.9, ... -1, -1.1, ...  
-2, ... -2.55 ...

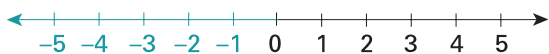

See integers, minus, positive numbers, zero

## net

A flat pattern which can be cut out, folded and glued together to make a three-dimensional model of a solid.

### Examples

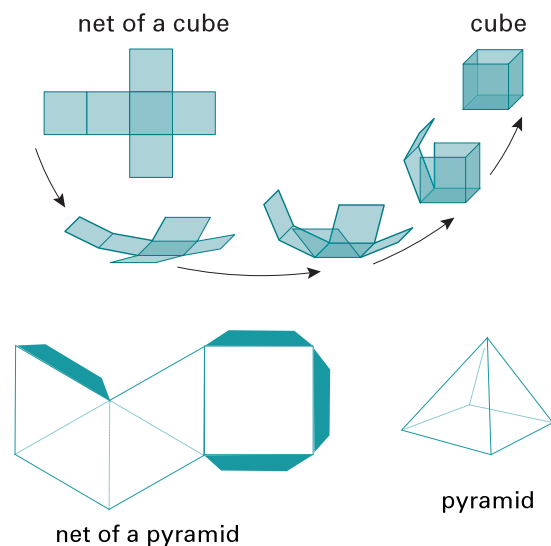

See cube, model, pattern, pyramid

## net mass

The mass of an object without packaging.

See gross mass

## network

A system of lines or arcs and intersections (nodes) drawn to represent paths and their intersections.

### Examples

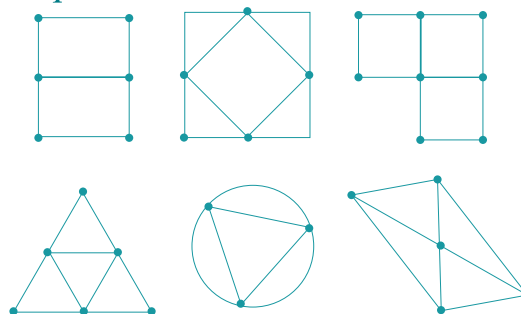

The properties of networks are studied as part of topology.

See intersection, node, topology

## node

A point where straight lines or curves intersect. It is also called a junction.

### Examples

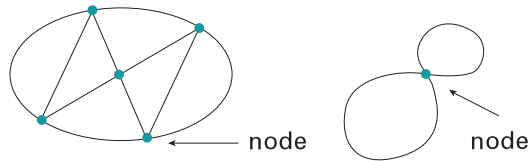

See intersect, network

## nonagon

A polygon with nine sides and nine angles.

### Examples

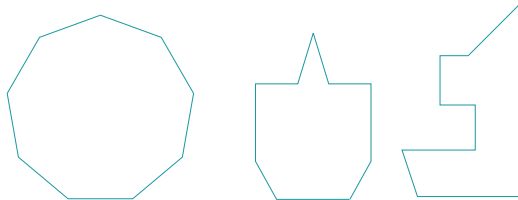

regular nonagon

irregular nonagons

See polygon

## none

Nothing. Not one. Not any.

### Example

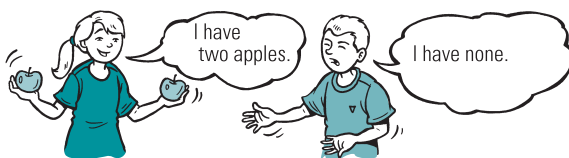

See zero

## non-planar figure

A three-dimensional figure. A solid or space figure.

### Examples

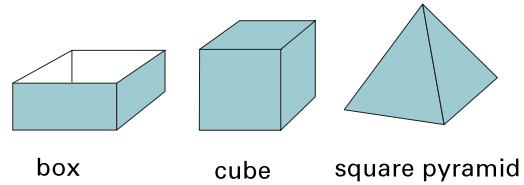

Non-planar means 'not in one plane'.

See planar figure

## not equal

(Symbol:  $\neq$ )

$$4 \neq 5$$

Four is not equal to five.

See inequality

## nothing

(Symbol: 0)

Not one. Having not a thing. Not anything. None. Zero.

## number

How many things. A measure of quantity.

Numbers are grouped into many different sets:

- (i) Natural (counting) numbers:  
 $1, 2, 3, 4, 5, 6, \dots$
- (ii) Whole numbers:  
 $0, 1, 2, 3, 4, 5, \dots$
- (iii) Integers:  
 $\dots -4, -3, -2, -1, 0, +1, +2, +3, \dots$
- (iv) Rational numbers, which include fractions and ratios:  
 $1 : 3 \quad \frac{1}{100}$

▼ **number continued...**





Other kinds of numbers include complex, composite, prime, odd, even, square, triangular, rectangular numbers, etc.

See composite number, even number, irrational number, integers, natural number, odd number, prime number, rational number, rectangular numbers, square number, triangle number, whole numbers

## number expander

A folded strip of paper used to learn place value.

*Example*

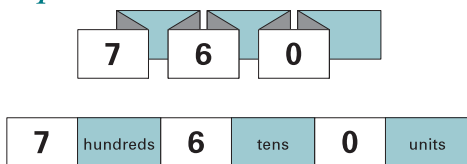

## number line

A line on which equally spaced points are marked. The points correspond, in order, to the numbers shown.

*Example*

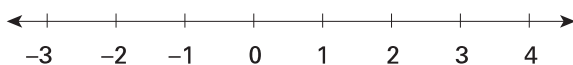

On a number line, the points are labelled from zero and move left of zero for negative numbers and right of zero for positive numbers. The numbers show the distance from zero to each point (using the distance between successive points as one unit).

Operations with numbers can be shown on a number line.

*Example*

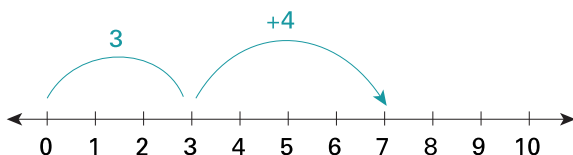

Add three and four.

$$3 + 4 = 7$$

See operation, order

## number machine

Number machines can carry out operations such as addition, subtraction, multiplication and division. Calculators and computers are types of number machines.

*Example*

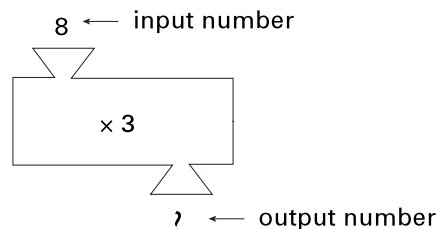

- 1 The number 8 is put into the machine. This is the input number.
- 2 The number is multiplied by three. This is the rule.
- 3 What comes out is the answer.

See calculator, rule

## number pattern

See pattern

## number sentence

A statement about numbers, usually in symbols rather than words.

*Examples*

$$6 + 7 = 13 \quad (\text{true})$$

$$4 \neq 9 \quad (\text{true})$$

$$5 + \square = 9 \quad (\text{open})$$

$$7 + 9 = 10 \quad (\text{false})$$

$$3 + 1 < 3 \times 1 \quad (\text{false})$$

See open number sentence, symbol

## number track

A track, as used in dice games, where the cells are numbered.

*Example*

14	13	12	11	10	9	8	7	6	5	4
15	30	29	28	FORWARD TO 35	27	26	25	24	3	3
16	31	42	41	40	39	38	37	36	23	2
17	GO BACK TO 29	43	GO BACK TO 34	FINISH			35	GO BACK TO 29	1	1
GO BACK TO 9	GO BACK TO 29	32	GO BACK TO 23	33	34	FORWARD TO 41	GO BACK TO 29	START	START	START
GO BACK TO 9	18	19	FORWARD TO 30	20	GO BACK TO 13	21	22	START	START	START

## numeral

A symbol used to represent a number.

*Example*

5 is the numeral which represents the number five.



5 apples

5 and V (Roman) are numerals for the number five.

*See numeration, Roman numerals, symbol*

## numeration

A system of symbols used to represent numbers. Our system uses the symbols

0, 1, 2, 3, 4, 5, 6, 7, 8 and 9.

*See Hindu–Arabic, symbol*

## numerator

The top number in a fraction. It tells how many parts of the whole there are.

*Example*

$\frac{3}{4}$  ← numerator

4 ← denominator

In  $\frac{3}{4}$  the numerator is 3.

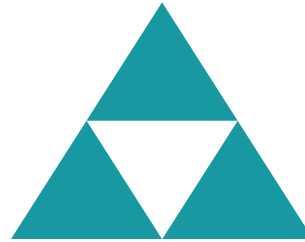

Three out of four equal parts are coloured.

*See denominator, fraction*



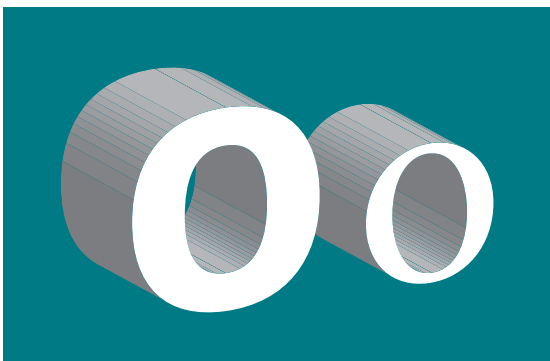

## oblique

A slanting line that is neither vertical nor horizontal.

### Examples

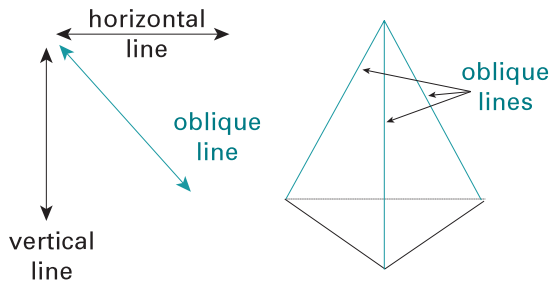

See askew

## oblong

Another word for a rectangle or for rectangular.

### Example



See rectangle

## obtuse angle

An angle bigger than a right angle ( $90^\circ$ ) but smaller than a straight angle ( $180^\circ$ ).

### Examples

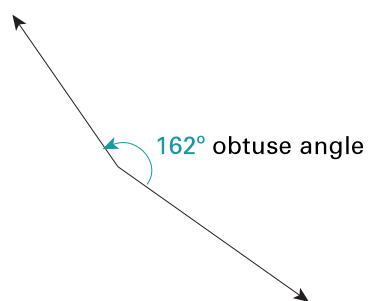
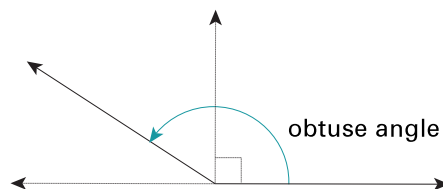

See angle, right angle, straight angle

## obtuse triangle

A triangle with one obtuse (larger than  $90^\circ$ ) angle.

### Examples

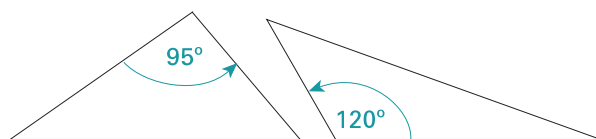

See acute

## o'clock

Used when telling time.

### Example

We say: six o'clock, ten o'clock ... only when talking about full hours.

Not used when telling hours and minutes: six fifteen, quarter to seven.

## octagon

A plane shape (polygon) with eight sides and eight angles.

### Examples

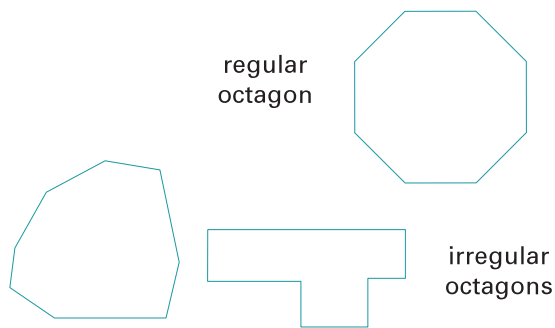

See plane shape, polygon

## octahedron

A solid (polyhedron) with eight faces.

A regular octahedron is formed by eight congruent equilateral triangles.

### Examples

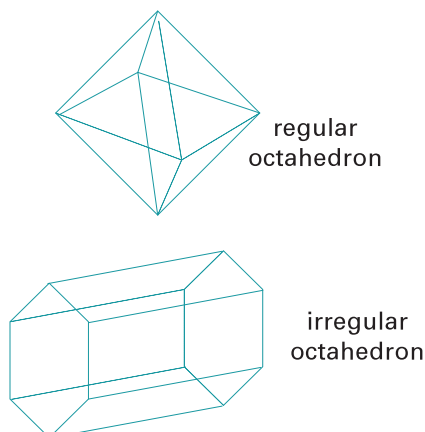

See polyhedron, regular polyhedron

## odd number

A number which, when divided by two, leaves a remainder of 1.

All odd numbers finish with one of the digits 1, 3, 5, 7 or 9.

See even number

## one-dimensional

(1D)

A figure which has only length is said to be one-dimensional.

### Examples

A line has only length; therefore, it has only one dimension.

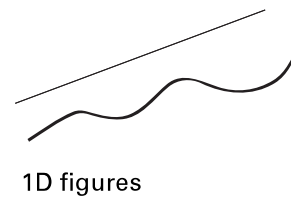

See dimension, plane

## one-to-one correspondence

(i) A matching of the objects of two sets.

### Examples

Cups and saucers  
Straws and bottles  
Jumpers and children



(ii) A correspondence between two sets for which each member of each set is paired with only one member of the other set. Arrows are used to show the corresponding objects.

▼ **one-to-one correspondence**  
*continued...*





**Example**

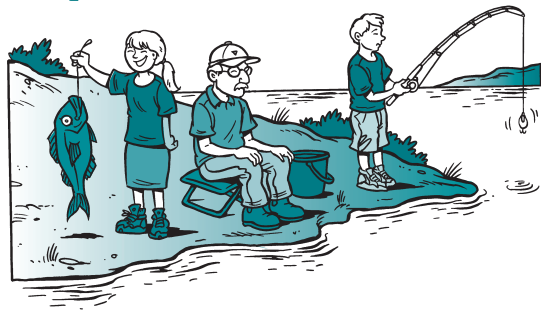

SET A = ( Jenny, Dad, Jim )



SET B = ( fish, cap, fishing rod )

See arrow diagram, correspondence, many-to-one correspondence

**open curve**

A curve which has a beginning and an end which do not meet.

**Examples**

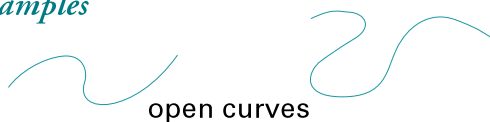

open curves

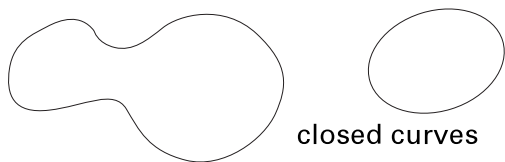

closed curves

See closed curve, curve

**open number sentence**

A mathematical sentence that contains numbers and variables. It can be an equation or an inequation.

**Examples**

Equations

$$5 + \triangle = 10$$

$$3 \square - 1 = 25$$

$$\frac{x}{2} - 5 = 7$$

Inequations

$$4a \neq 9$$

$$5x - 5 < 33$$

$$10 - y \geq 28$$

See equation, inequality, inequation, number sentence

**operation**

There are four arithmetic operations:

**Examples**

Addition + 2 + 4

Subtraction - 7 - 3

Multiplication × 10 × 5

Division ÷ 8 ÷ 4

See addition, arithmetic, basic facts, division, multiplication, order of operations, subtraction

**operators**

The signs used in operations.

+ - × ÷

**Examples**

$$10 + 2 \quad 7 \times 3 \quad 8 - 4 \quad 18 \div 6$$

See operation

**opposite numbers**

Numbers that add up to zero.

**Example**

$$-5 + 5 = 0$$

The opposite to -5 is 5;

the opposite to 320 is -320.

**order**

- (i) To order means to arrange in a pattern or a sequence.
- (ii) Order means a pattern or a sequence.
- (iii) Order of numbers on a number line.

See ascending order, descending order, number line, pattern, sequence





## ordinal number

A number which indicates position.

### Examples

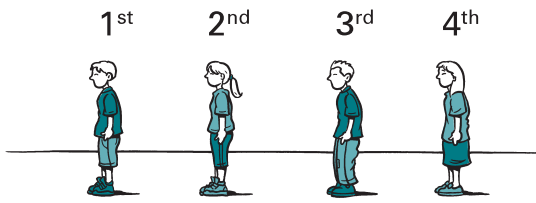

See cardinal number

## ordinate

The  $y$ -axis in a Cartesian coordinate system is also called the ordinate.

See axis, coordinates

## origin

A point at which something begins.

### Example

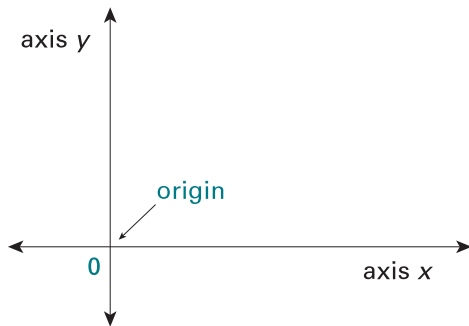

The coordinates of the origin are  $(0, 0)$ .

The point where axes  $x$  and  $y$  intersect is called the origin and is marked 0.

See axis, coordinates, intersect, ordered pair

## outcome

The result of an experiment or trial involving the unknown.

### Example

In tossing a coin, there are two possible outcomes, either heads or tails.

## output

See number machine

## oval

- (i) An egg-shaped figure which is symmetrical about one axis. One end is more pointed than the other.

### Example

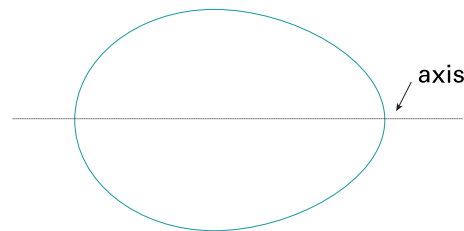

- (ii) Another word for an ellipse, which is symmetrical about two axes.

### Example

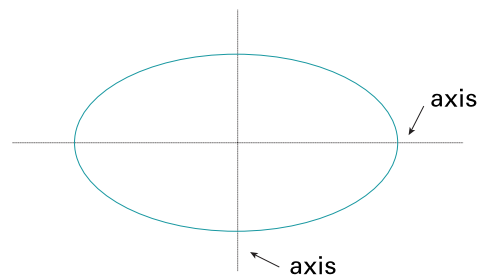

See axis, ellipse, symmetry

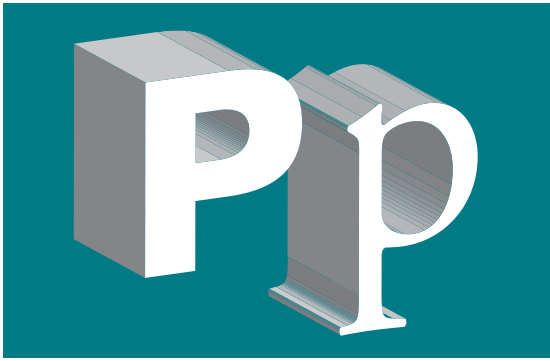

## p.a.

Per annum. Per year.

### Example

The bank charges 7% interest p.a.

## pace

The distance between your feet when you take a step. It is measured from heel to heel. It is used as an arbitrary unit for estimating distances.

### Example

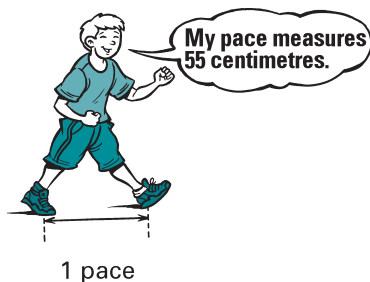

See arbitrary unit, distance, estimate

## pair

Two things that belong together.

### Example



a pair of socks

## palindrome

A number or word that reads the same forward as backward.

### Examples

1991    19.9.1991    madam

## pantograph

An instrument for tracing a drawing, map or a picture. Also used for the enlargement or reduction of an original.

### Example

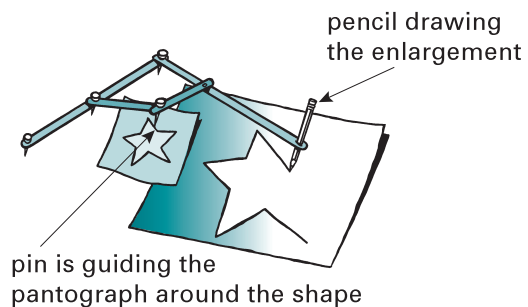

See enlargement

## parabola

A parabola is a conic section made by the intersection of a right circular cone and a plane. It can also be defined as a locus of points that are equidistant from a given point (the focus) and a fixed line (the directrix).

### Example

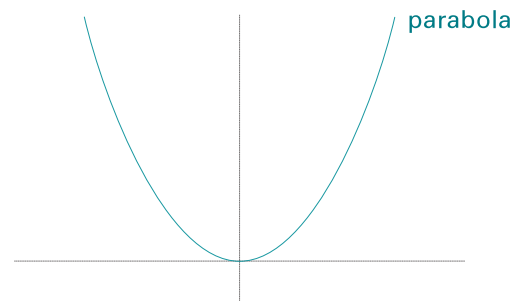

See conic section, equidistant



## parallelepiped

A prism, made of parallelograms.

*Example*

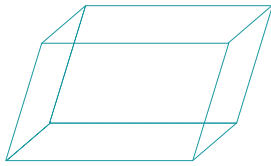

See parallelogram, prism

## parallel lines

(Symbols:  )

Two or more lines that go in exactly the same direction. Parallel lines always remain the same distance apart. They never meet.

*Example*

Train lines are parallel.

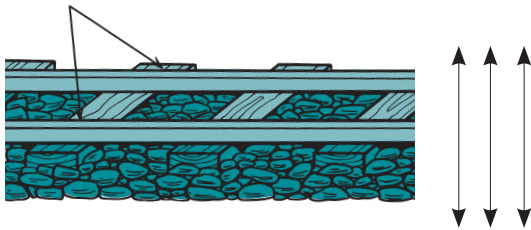

When parallel lines are crossed by a transversal, pairs of angles are formed. They have special properties:

- 1 corresponding angles (make F-shape). They are equal.

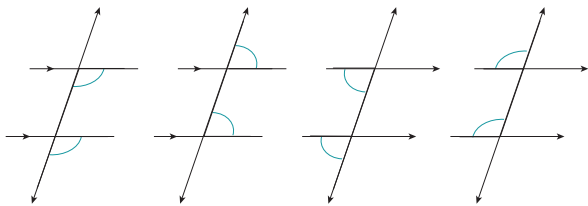

- 2 alternate angles (make Z-shape). They are equal.

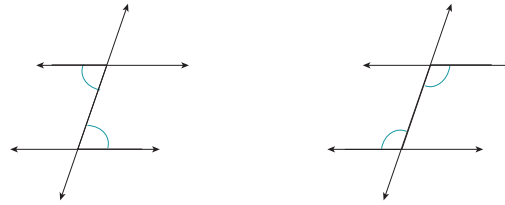

- 3 cointerior angles (make U-shape). They add up to 180°.

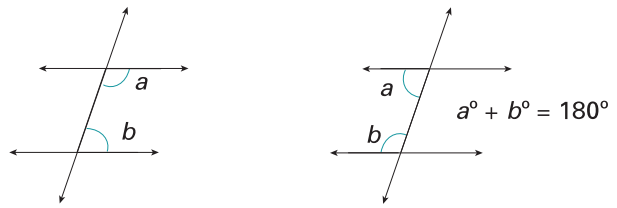



See transversal, vertically opposite angles

## parallelogram

A four-sided figure (quadrilateral) in which both pairs of opposite sides are parallel and equal, and the opposite angles are equal.

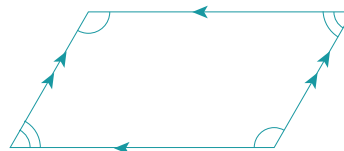
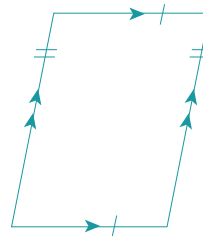
*Examples*



The arrow marks   show which pairs of lines are parallel.

A right-angled parallelogram is a rectangle.

*Example*

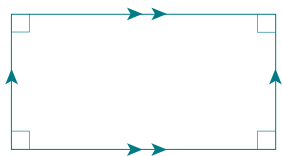

See parallel lines, quadrilateral, rectangle

## parentheses

Word for ordinary brackets used for grouping numbers together.

*Example*

$$( ) \quad (2 + 3) - (5 + 2)$$

parenthesis,  
or ordinary  
brackets

$$= 5 - 7$$

$$= -2$$

See braces, brackets, order of operations

## partition

See division

## Pascal's triangle

Used in probability.

			1					
		1		1				
	1		2		1			
	1	3		3		1		
	1	4	6	4	1			
	1	5	10	10	5	1		
	1	6	15	20	15	6	1	
	1	7	21	35	35	21	7	1

Notice that after the second line the new numbers are made by adding the numbers in the previous line.

## path

A connected set of points.

The route or line along which a person or object moves.

*Example*

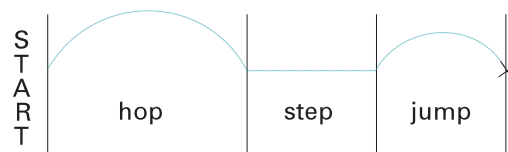

the path of my hop-step-jump

## pattern

A repeated design or arrangement using shapes, lines, colours, numbers, etc.

*Examples*

(i) Shape pattern

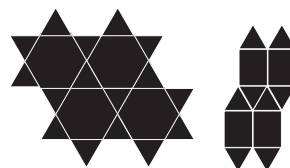

(ii) Colour pattern



(iii) A 'number pattern' is a sequence of numbers formed by following a 'rule':

1, 4, 7, 10 ... (rule: add three)

16, 8, 4, 2, 1,  $\frac{1}{2}$ ,  $\frac{1}{4}$ ,  $\frac{1}{8}$  ...  
(rule: divide by two)

See rule, sequence



## pattern blocks

Sets of plastic, wood or cardboard shapes in the form of triangles, squares, parallelograms, hexagons, etc.

### Examples

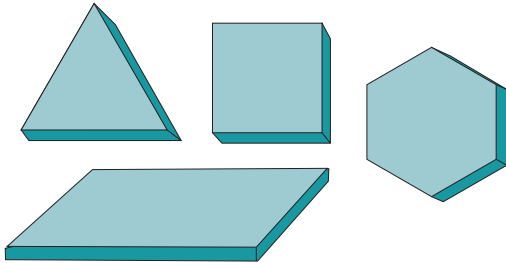

## pegboard

Plastic or wooden board containing holes in which pegs can be placed.

### Example

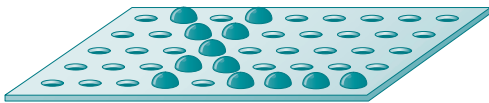

Coloured pegs are used to represent numbers, patterns or shapes.



## pendulum

A small heavy object attached to a string suspended from a fixed point.

### Example

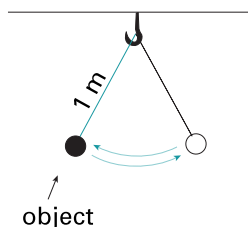

If the string is one metre in length, then it takes about one second to make a single complete swing, over and back.

See [second](#)

## pentagon

A shape (polygon) with five straight sides and five angles.

### Examples

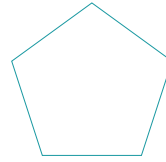

regular pentagon

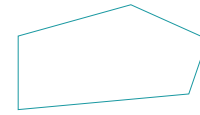

irregular pentagon

See [polygon](#)

## per annum

(p.a.)

Yearly, per year.

## per cent (percentage)

(Symbol: %)

A number out of one hundred.

### Example

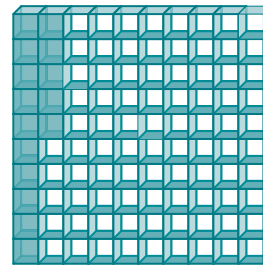

This is a 'hundred square'. Fifteen out of the hundred little squares have been coloured in. They represent:

$$\frac{15}{100} = 15\% = 0.15$$

↑                    ↑                    ↑  
 fraction    percentage    decimal fraction

See [decimal fraction](#), [fraction](#)

## perimeter

The distance around a closed shape, or the length of its boundary.

### Example

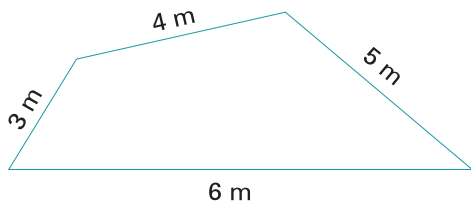

To find the perimeter of a shape, add the lengths of all its sides.

The perimeter is:

$$3 \text{ m} + 4 \text{ m} + 5 \text{ m} + 6 \text{ m} = 18 \text{ m}$$

See [boundary](#), [circumference](#)

## permutation

An ordered arrangement or sequence of a group of objects.

### Example

Three shapes 

can be arranged in six different ways, or have six permutations.

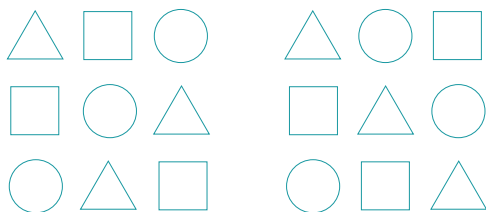

The order in which the shapes are arranged is important in a permutation. When the order is not important, the arrangement is called a combination.

See [combination](#)

## perpendicular

Forming a right angle.

(i) Perpendicular height.

The line segment drawn from the vertex (top) of a figure to the opposite side at a  $90^\circ$  angle.

### Examples

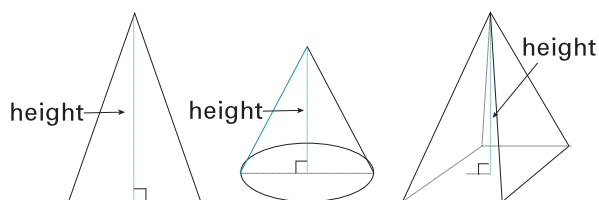

The height of a triangle, cone or pyramid

(ii) Perpendicular lines.

Lines which intersect to make right angles.

### Examples



See [altitude](#), [apex](#), [cone](#), [line segment](#), [pyramid](#), [triangle](#), [vertex](#)

## perspective

When drawing on paper, we can show depth by drawing all parallel lines running into one or several points on the horizon. These points are called vanishing points. The drawing looks as if it is three-dimensional. We say it has perspective.

### Example



See [converging lines](#)



## pi

(Symbol:  $\pi$ )

The ratio of the circumference of a circle to its diameter.

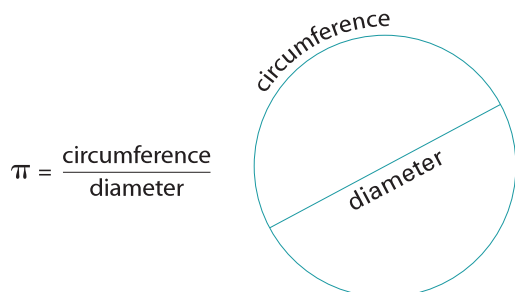

$$\pi = \frac{\text{circumference}}{\text{diameter}}$$

The approximate value of  $\pi$  is 3.14.

The exact value cannot be worked out.

See chronological order, circle, circumference, diameter, infinite decimal, radius

## pictograph

(pictogram)

A graph drawn with pictures that represent the real objects.

*Example*

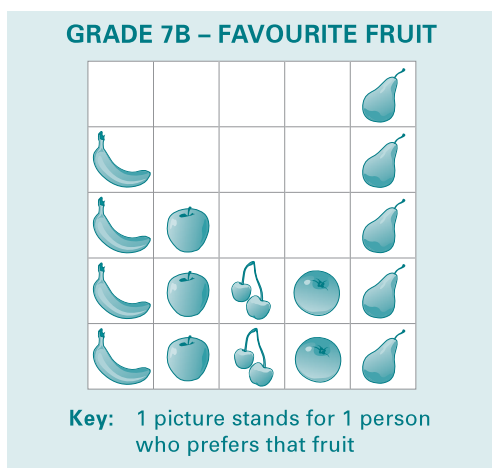

A pictograph must have a heading and a key.

See graph

## picture graph

Another name for a pictograph.

## pie graph

(pie chart)

A circle graph. Also called a sector graph.

*Example*

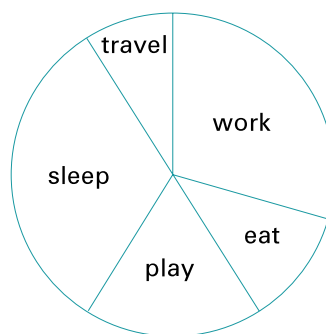

How Linda spends a day

See graph

## place holder

- (i) A symbol which holds the place for an unknown number.

*Examples*

In  $w + 3 = 7$ ,  $w$  is the place holder.

In  $\square - 6 = 10$ ,  $\square$  is the place holder.

- (ii) Zero, when used with other digits, is used as a place holder.

*Example*

6800

The zero in place of units and tens helps us to see that the numeral 8 means eight hundreds, the numeral 6 means six thousand and that there are no units and no tens.

See digit, equation, variable



## place value

The value of each digit in a number depends on its place or position in that number.

*Examples*

hundreds	tens	ones
4	8	6
	1	8
8	2	3

In the number 486 the value of digit 8 is 80 (eight tens).

In the number 18 the value of digit 8 is 8 (eight units).

In the number 823 the value of digit 8 is 800 (eight hundreds).

*See* decimal place-value system, digit, value

## plan

(i) To prepare ahead of time.

*Example*

Plan for a holiday.

(ii) A diagram of an object as seen from above.

*Example*

**3A CLASSROOM FLOOR PLAN**

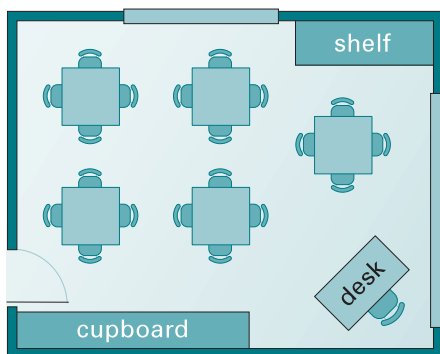

*See* cross-section of a solid, diagram, front view, side view

## planar figure

A two-dimensional shape, such as a triangle. Also called a plane figure or plane shape.

*Examples*

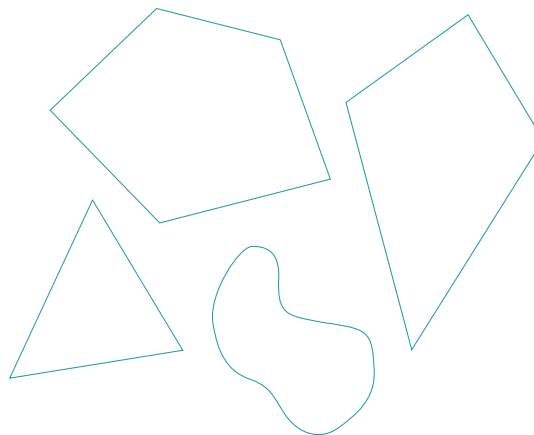

*See* plane shape, triangle, two-dimensional

## plane

A flat surface, like the floor of a house or a wall.

A plane extends infinitely in all directions.

Two-dimensional objects are called plane shapes or planar figures because they can be drawn in one plane.

*Example*

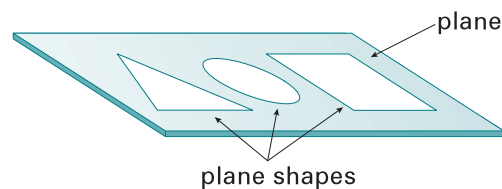

*See* dimension, infinite, planar figure, two-dimensional



## plane shape

A plane shape is a closed shape that can be drawn on a flat surface.

### Examples

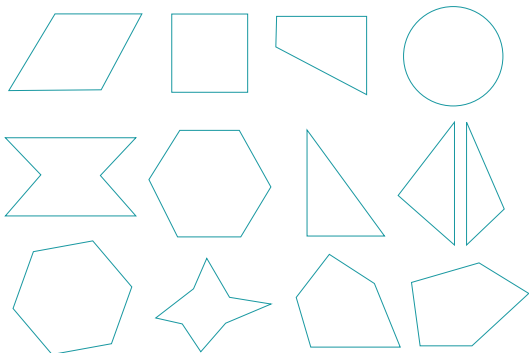

See non-planar figure, planar figure

## platonic solids

See regular polyhedron

## plus

(Symbol: +)

The name of the symbol that means addition.

### Example

$$4 + 6 = 10$$

See addition



## p.m.

(post meridiem)

The time from immediately after midday until immediately before midnight.

The abbreviation p.m. is used only with 12-hour time.

### Example

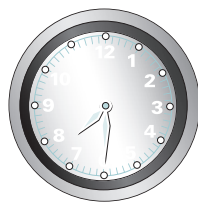

It is evening.

The time is half past seven.

It is 7.30 p.m.

See a.m.

## point

- (i) Small dot on a surface. It has no dimension.

. P

The dot shows where the point P is.

- (ii) The dot, called the decimal point, shows that 4 means four dollars and 50 is fifty cents.

\$4.50

See decimal point

## polygon

A plane shape which has three or more straight sides; for example, a triangle, quadrilateral, pentagon or hexagon.

### Examples

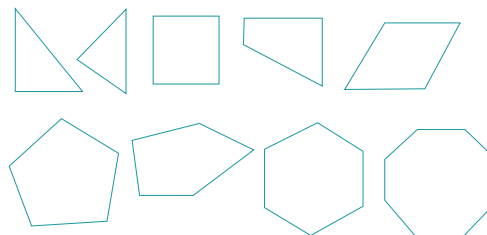

See closed shape, hexagon, irregular polygon, line segment, octagon, pentagon, quadrilateral, regular polygon, triangle

## polyhedron

(Plural: polyhedrons or polyhedra)

A three-dimensional shape with plane faces.

### Examples

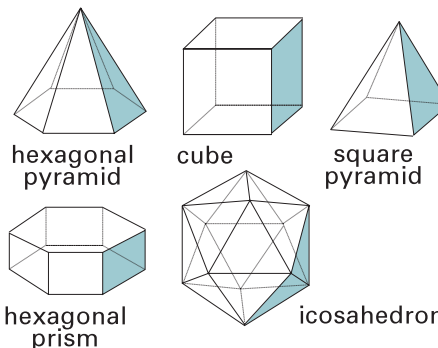

hexagonal pyramid

cube

square pyramid

hexagonal prism

icosahedron

See cube, dodecahedron, icosahedron, prism, pyramid, regular polyhedron

## polyomino

A plane shape made of squares of the same size, each square being connected to at least one of the others by a common edge.

### Examples

domino – two squares



triomino – three squares

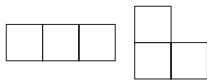

tetromino – four squares

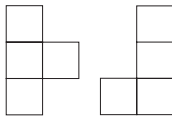

pentomino – five squares

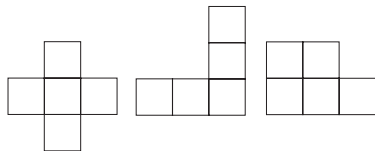

See planar figure

## position

Describes the place where something is.

### Examples

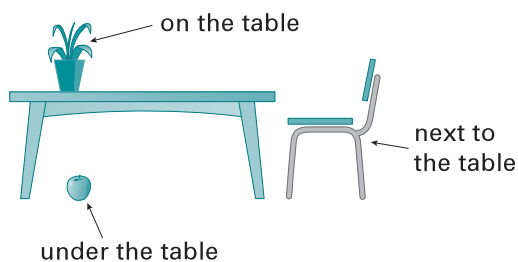

On, under, above, behind, in front of, between, next to, outside, etc.

See coordinates, ordered pair

## positive numbers

Numbers greater than zero. We sometimes write the plus sign (+) in front of them.

### Examples

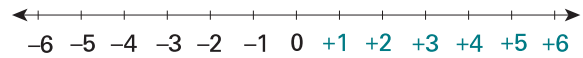

+4, +5, +6 ...+937, +938 ...

See integers, negative numbers, plus, zero

## power of a number

In  $2^4$  the power is 4. It is also called the index.

It means  $2 \times 2 \times 2 \times 2 = 16$

Say: two to the power of four.

When the power is zero, the value is one.

$10^0 = 1$     $1000^0 = 1$

See cubed number, index, index notation, square number, zero power

## prediction

In mathematics we can predict or estimate possible answers.

See estimate, probability



## prefix

A word before a unit, showing us how large the measure is.

### Example

One millimetre means one thousandth of a metre.

See section Prefixes tables on pages 153–4

## prime factor of a number

A prime number that will divide exactly into a given number.

### Example

2, 3 and 5 are the prime factors of thirty. (10 is a factor of thirty, but not a prime factor.)

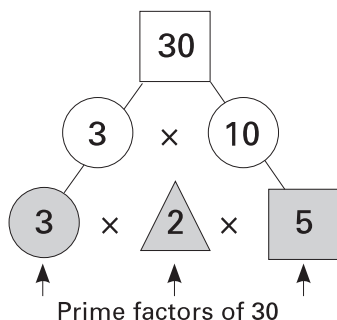

See factor tree, factors, prime number

## prime number

A counting number that can only be divided by one and itself.

### Examples

2, 3, 5, 7, 11, 13, 17 ...

The factors of two are 2 and 1.

The factors of five are 5 and 1.

A prime number has only two factors, itself and 1.

Note: Number 1 is usually considered to be neither prime nor composite.

See composite number, counting number, factors

## principal

The amount borrowed or invested is called the principal.

### Example

Joe borrowed \$100 from a bank. The principal is \$100.

See interest, interest rate

## prism

A solid figure with two faces that are parallel and the same in size and shape. They can be any polygon.

### Examples

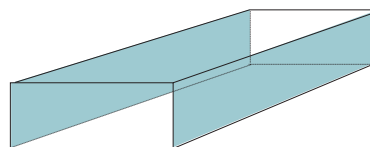

rectangular prism

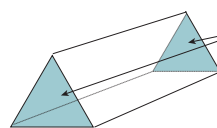

These two faces are parallel and the same shape and size.

triangular prism

All cuboids are prisms.

See cuboid, face, parallel lines, polygon, polyhedron, prism, three-dimensional

## probability

The likelihood of an event happening.

### Example

If a coin is tossed, the probability of getting tails is  $\frac{1}{2}$ .

See chance event, equally likely

## problem solving

Using your understanding and knowledge of mathematical concepts and principles to find a solution in a new or unfamiliar situation.

## product

The answer to a multiplication problem.

*Example*

$$\begin{array}{ccccccc} 3 & \times & 2 & = & 6 & & \\ \uparrow & & \uparrow & & \uparrow & & \end{array}$$

multiplicand multiplier product

Six is the product.

*See* associative property of multiplication, commutative property of multiplication, multiplicand, multiplication, multiplier

## profit

If the selling price is higher than the cost price the seller makes a profit.

*Example*

A car dealer buys a car for \$10 000 and sells the same car for \$12 000. As the selling price is higher than the buying price, the dealer makes a profit of \$2000.

*See* cost price, loss, selling price

## progression

A sequence of numbers following a given rule. The numbers in a progression increase or decrease in a constant way.

- (i) If the rule is 'add a number', it is called an *arithmetic progression*.

*Examples*

Rule: add 3            1, 4, 7, 10, 13, 16, ...

Rule: subtract 2        21, 19, 17, 15, 13, 11, ...

- (ii) If the rule is 'multiply by a number', it is called a *geometric progression*.

*Examples*

Rule: multiply by 4    1, 4, 16, 64, 256, ...

Rule: divide by 2        12, 6, 3, 1.5, 0.75, ...

*See* decrease, increase, sequence

## projection

The transformation of one shape or picture to another.

*Example*

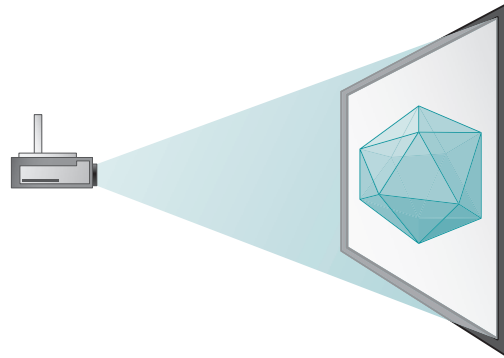

Projecting a picture onto a screen

*See* transformation

## pronumeral

Another word for the symbol representing an unknown value in an equation. The pronumeral stands for a particular value.

*Examples*

$$2a = 6 \qquad 7 - x = 5 \qquad 12 \times \square = 24$$

$$a = 3 \qquad x = 2 \qquad \square = 2$$

$a$ ,  $x$  and  $\square$  are pronumerals.

*See* algebraic expression, symbol, variable



## proper fraction

A fraction where the numerator is less than the denominator.

*Examples*

$$\frac{4}{5}$$

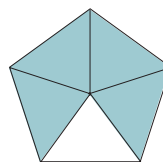

$$\frac{36}{100}$$

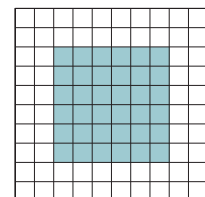

*See* denominator, fraction, improper fraction, numerator, simple fraction

**property**

A characteristic of an object.

See attribute, classification, classify

**proportion**

A statement of equality between two ratios.

(i) Direct proportion.

When a relation between two variables remains constant, they are said to be in direct proportion.

*Example*

Mary reads three pages of a book every ten minutes.

The ratio  $\frac{\text{pages}}{\text{time}}$  is constant.

$$\frac{3 \text{ pages}}{10 \text{ min}} = \frac{6 \text{ pages}}{20 \text{ min}} = \frac{9 \text{ pages}}{30 \text{ min}} = \frac{12 \text{ pages}}{40 \text{ min}} \dots$$

(ii) Indirect (or inverse) proportion.

When one variable is multiplied by a number and the other variable is divided by the same number, they are said to be in indirect proportion.

*Example*

It takes four hours for one person to mow the lawn.

It takes two hours for two people to mow the lawn.

Number of people	1	2	3	4	8
Time in hours	4	2	$1\frac{1}{3}$	1	$\frac{1}{2}$

See inverse, ratio, variable

**protractor**

An instrument used to measure and draw angles.

*Example*

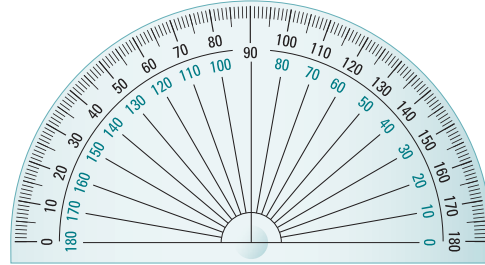

**prove**

Test correctness of calculation.

**pyramid**

A solid (3D shape) which has a polygon for a base and all the other faces are triangles.

*Example*

This pyramid has a square base and the other faces are congruent triangles.

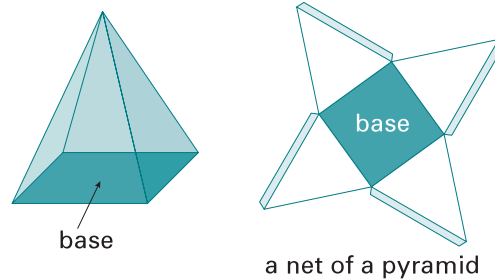

A tetrahedron is a pyramid with a triangular base.

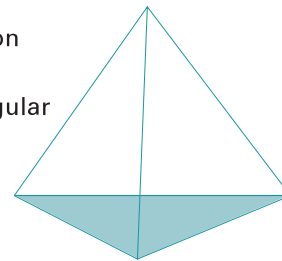

The base of a pyramid can be any polygon.

See apex, base, face, isosceles triangle, net, polygon, solid, tetrahedron, vertex



## Pythagoras' theorem

In any right-angled triangle, the square of the hypotenuse is equal to the sum of the squares of the sides.

*Example*

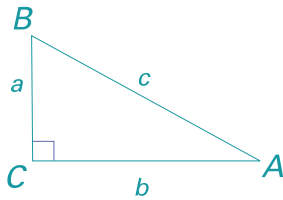

$$c^2 = a^2 + b^2$$

$$a^2 = c^2 - b^2$$

$$b^2 = c^2 - a^2$$

$$c^2 = a^2 + b^2$$

$$5^2 = 3^2 + 4^2$$

$$25 = 9 + 16$$

$$25 = 25$$

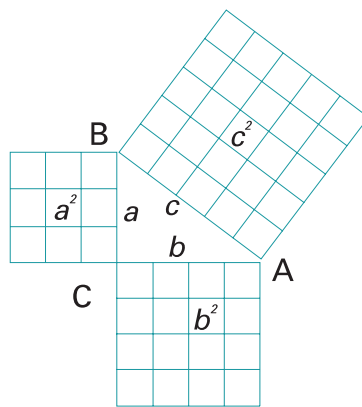

$$a = \sqrt{c^2 - b^2}$$

$$b = \sqrt{c^2 - a^2}$$

$$c = \sqrt{a^2 + b^2}$$

See right-angled triangle





## quadrilateral

A plane shape with four sides and four angles.

*Example*

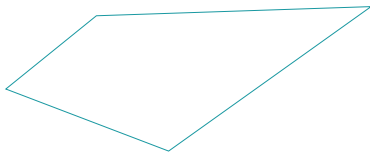

Some special quadrilaterals are:

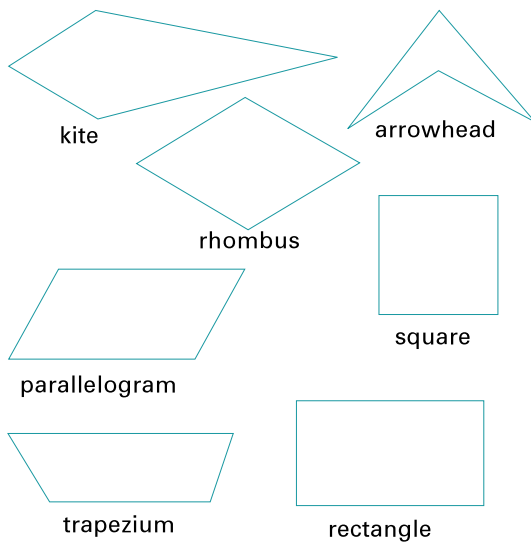

See kite, parallelogram, planar figure, rectangle, rhombus, square, trapezium

## quadrant

(i) A quarter of the circumference of a circle.

*Example*

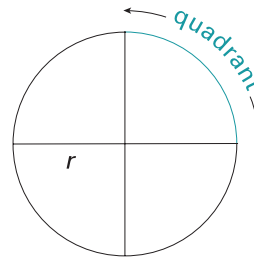

(ii) A plane figure made by two radii of a circle at a  $90^\circ$  angle and the arc cut off by them.

*Example*

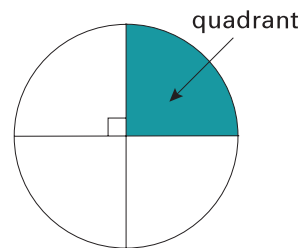

(iii) In coordinate geometry we use the space between the  $x$ -axis and  $y$ -axis. We can extend the  $x$ -axis and the  $y$ -axis so that all four quadrants of the number plane can be seen. Quadrants are numbered in an anticlockwise direction.

*Example*

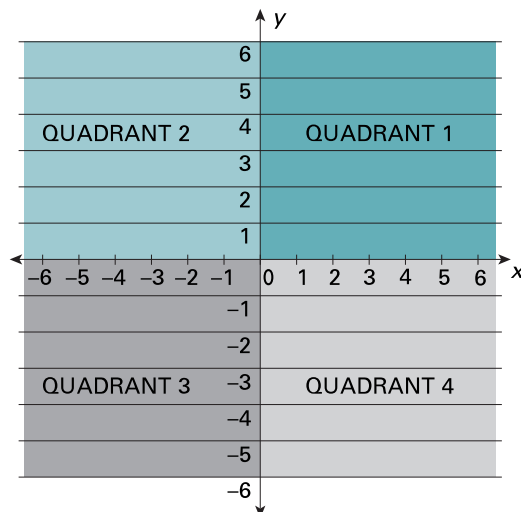

See arc, coordinates, ordered pair, radius



## quadruple

Increase the amount four times.

### Example

quadruple \$20 means

$$4 \times \$20 = \$80$$

See double, treble

## quantity

The amount or number of something.

### Example

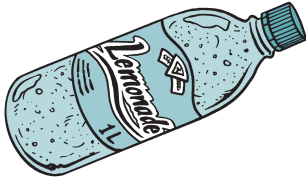

The quantity of lemonade in the bottle is one litre.

## quarter

One of four equal parts.

### Examples

$\frac{1}{4}$  is shaded

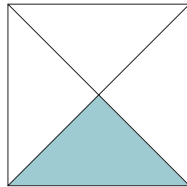

Quarter of the boys are sitting.

## quotient

The answer to a division problem.

### Example

$$\begin{array}{ccccccc} 10 & \div & 2 & = & 5 \\ \uparrow & & \uparrow & & \uparrow \\ \text{dividend} & & \text{divisor} & & \text{quotient} \end{array}$$

Five is the quotient.

See dividend, division, divisor

## quotation

See division



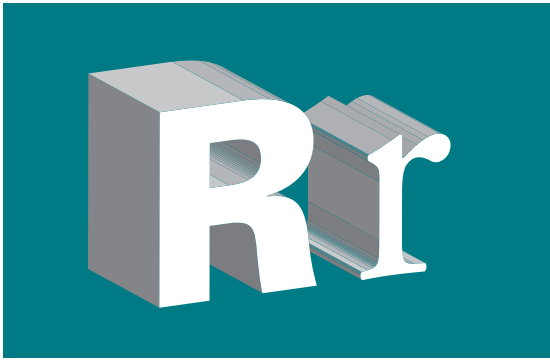

## radian

The radian is the angle at the centre of a circle (approximately  $57.3^\circ$ ), when the length of the arc is equal to the radius.

*Example*

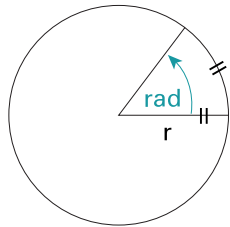

See arc, radius

## radiant point

A point from which rays or radii start.

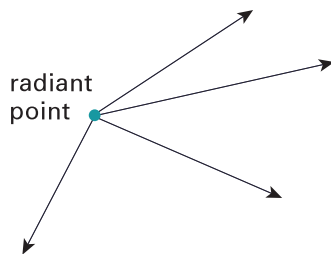

See ray

## radius

(Plural: radii)

- (i) The distance from the centre of a circle to its circumference (or from the centre to the surface of a sphere).

*Example*

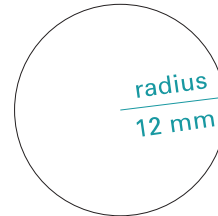

- (ii) The line segment joining the centre and a point of the circle (like the spoke of a wheel) or a line segment joining the centre of a sphere to a point on its surface.

*Example*



See circle, circumference, diameter, line segment, sphere

## random sample

A term in statistics meaning a part or portion which is chosen to represent the whole.

*Example*

A bag with twenty black and twenty white balls. A random sample may be three white and two black balls.



See statistics

## range

The range is the difference between the largest and the smallest number in a set.

### Example

{1, 2, 3, 4, 5, 6}

The smallest number is 1.

The largest number is 6.

The range is  $6 - 1 = 5$ .

## rate

- (i) The comparison between two quantities, which may be of different things.

### Example

Sixty kilometres per hour (60 km/h) is the rate of travel.

- (ii) The exchange rate is the comparison of values of money.

### Example

US\$1 = A\$0.67

See comparison

## ratio

(Symbol: :)

A comparison of two quantities.

We express one quantity as a fraction of the other.

### Example

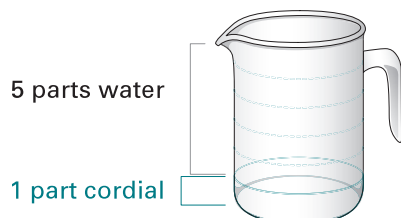

To make a jug of cordial, mix the cordial and water in the ratio of 1 : 5. This means that you mix one part of cordial to five parts of water.

The order of the numbers is important:

$1 : 5 \neq 5 : 1$ .

See comparison

## rational number

A number that can be expressed as a fraction or ratio of integers.

### Examples

$$\frac{3}{4} \quad 0.5 = \frac{1}{2} \quad 8 = \frac{8}{1}$$

All rational numbers can be represented by either:

- (i) decimal numbers that terminate

### Examples

$$\frac{3}{4} = 0.75 \quad \frac{1}{8} = 0.125$$

- (ii) non-terminating, repeating decimals.

### Examples

$$\frac{2}{3} = 0.\dot{6} \quad \frac{-4}{11} = -0.\dot{3}\dot{6}$$

See fraction, ratio, recurring decimal

## ray

A line that has a starting point but no end. It extends in one direction only.

### Examples

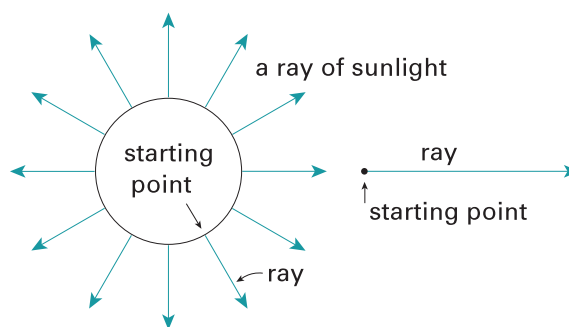

See angle, line, line segment, radiant point

## real number

The set of real numbers is made up of all rational and irrational numbers.

See irrational number, rational number

## reciprocal

The reciprocal of a fraction is the fraction obtained by interchanging the numerator and denominator.

### Example



- (i) Since we can write 4 as  $\frac{4}{1}$  the reciprocal of 4 is  $\frac{1}{4}$ .
- (ii) Reciprocal of  $\frac{2}{3}$  is  $\frac{3}{2}$  or  $1\frac{1}{2}$ .

## rectangle

A quadrilateral with two pairs of equal and parallel sides, and four right angles.

### Example

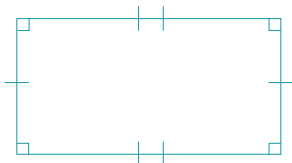

A rectangle is sometimes called an oblong.  
See parallel lines, quadrilateral, right angle



## rectangular numbers

Numbers that can be represented by dots arranged in a rectangle.

### Examples

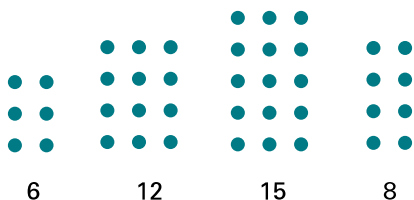

## rectangular prism

A polyhedron whose base is a rectangle.  
Another name for a cuboid.

### Examples

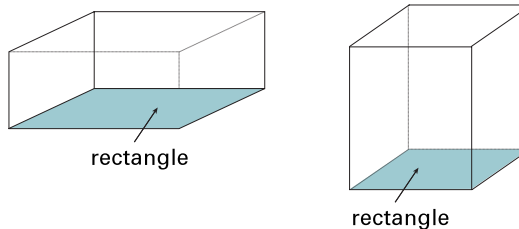

Most boxes are rectangular prisms.

See cuboid

## recurring decimal

A decimal fraction in which one or more digits are repeated indefinitely.

### Examples

- (i)  $\frac{1}{3} = 0.33333 \dots = 0.\dot{3}$   
It is written  $0.\dot{3}$ . The dot shows that the digit is repeated.
- (ii)  $0.1\dot{7}$   
These dots show that the digits 1 and 7 are repeated.  
 $0.1717171717 \dots$
- (iii)  $\frac{1}{7} = 0.142857142857 \dots$   
It is written either as  $0.\dot{1}4285\dot{7}$  or  $0.14285\overline{7}$  to show the repeated digits.

See decimal fraction, digit, rational number, terminating decimal

## reduce

- (i) Simplify. Express a fraction in its simplest form.

### Example

$\frac{5}{30}$  can be reduced to  $\frac{1}{6}$

- (ii) Make smaller.

See cancelling, enlargement, fraction, transformation

## reflection

Being reflected. Reflecting.

### Examples

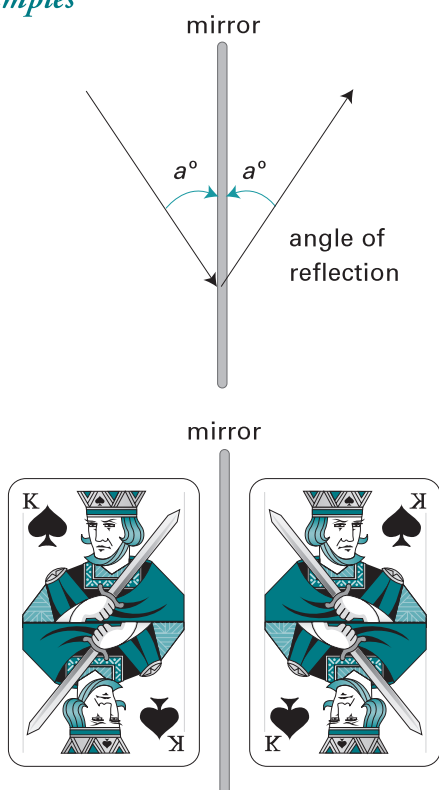

See flip, mirror image

## reflex angle

An angle greater than a straight angle ( $180^\circ$ ) but less than a revolution ( $360^\circ$ ).

### Examples

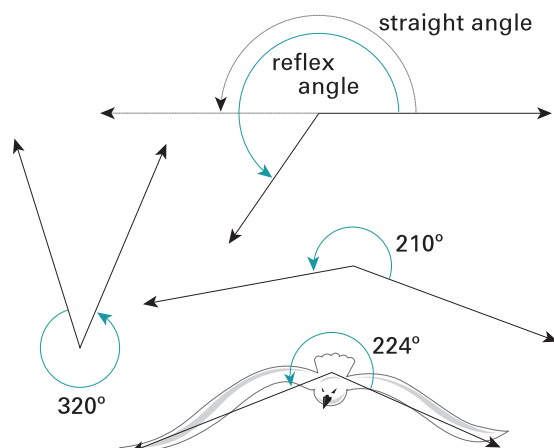

See angle, revolution, straight angle

## region

(i) Plane region.

All the points inside a simple closed shape together with all of the points on the boundary of the shape.

### Example

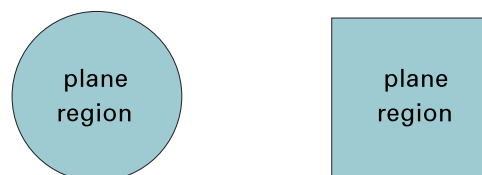

(ii) Solid region.

All the points inside a closed surface together with all the points on the surface.

### Example

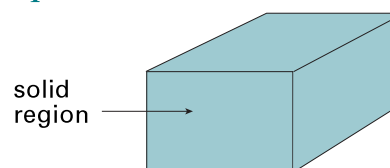

See boundary, plane, solid, surface

## regroup

Exchange.

### Examples

(i) Twelve unit blocks can be regrouped (exchanged) for one long (10) and two units.

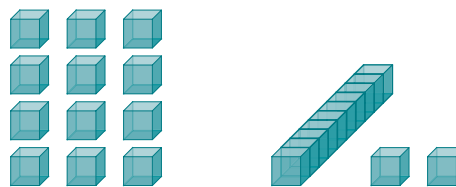

(ii) Before subtracting fifteen, the eight tens and two units have been regrouped into seven tens and twelve units.

$$\begin{array}{r} 7 \overline{)82}^{12} \\ - 15 \\ \hline 67 \end{array}$$

See carrying, group, multibase arithmetic blocks (MAB)



## regular polygon

A polygon is regular if its sides are equal in length and its angles are equal in size.

Some common regular polygons are:



equilateral triangle

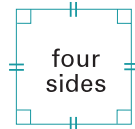

square

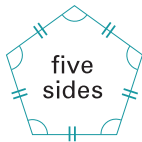

regular pentagon

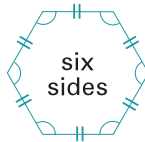

regular hexagon

See equilateral triangle, hexagon, irregular polygon, pentagon

## regular polyhedron

A polyhedron whose faces are congruent regular polygons that are exactly the same in shape and size. Internal angles are also the same in size. Regular polyhedrons are also called platonic solids.

There are only five regular polyhedrons:

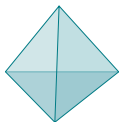

tetrahedron

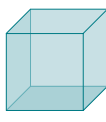

hexahedron  
(cube)

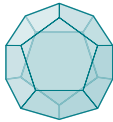

dodecahedron

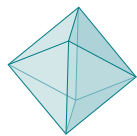

octahedron



icosahedron

See congruent, dodecahedron, face, hexahedron, icosahedron, octahedron, polyhedron, tetrahedron

## regular shape

See regular polygon

## relation

Connection, correspondence or contrast between a pair of objects, measures, numbers, etc. Also called relationship.

### Examples

- (i) Family relationship:  
Judi is the sister of Lea.



- (ii) Size relation:  
Jan is taller than Helen.



- (iii) Mathematical relation.

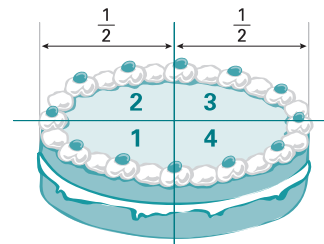

2 is half of 4

- (iv) Relation between pairs of numbers.  
Often presented in a table.

x	1	2	3	4	5
y	6	7	8	9	10

$$y = x + 5$$

See arrow diagram, correspondence

## remainder

The amount left over after division.

### Example

$$\begin{array}{r} 25 \\ 5 \overline{) 128} \\ \underline{25} \\ 28 \\ \underline{25} \\ 3 \end{array}$$

There are different ways of expressing the remainder in the answer. They depend on the question.

↑ remainder

- (i) Question: Five boys share 128 marbles. How many marbles each?

Answer: Each boy gets 25 marbles. 3 marbles are left over.

- (ii) Question: Share \$128 among five girls.

Answer: Each girl gets \$25 and  $\frac{3}{5}$  of a dollar; that is, \$25 and 60c.

See division

## repeating decimal

See recurring decimal

## reverse

The other way round, or opposite way round.

### Example

The reverse of 385 is 583.

## reverse operation

Multiplication is the reverse of division.

Addition is the reverse of subtraction.

See inverse operations, operation

## revolution

One complete turn. There are  $360^\circ$  in one revolution.

There are four right angles in one revolution.

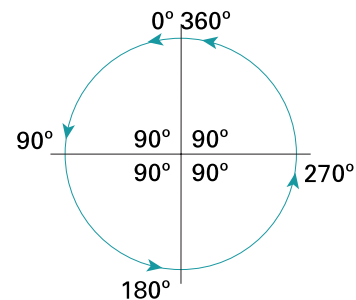

See angle, right angle

## rhombus

A shape (parallelogram) with four equal sides. Opposite angles are equal.

### Examples

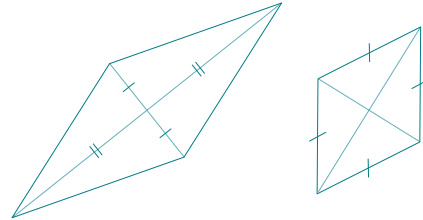

See diamond, parallelogram



## right angle

(Symbol:  $\perp$ )

An angle measuring exactly  $90^\circ$ .

### Examples

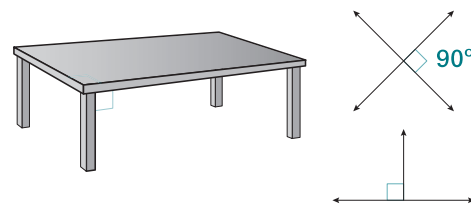

See angle

## right-angled triangle

A triangle with a right angle.

*Examples*

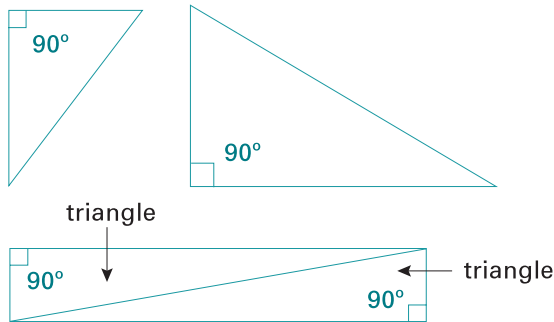

See hypotenuse, Pythagoras' theorem, right angle, tangent ratio

## right 3D shape

A solid with ends or base perpendicular to height.

*Examples*

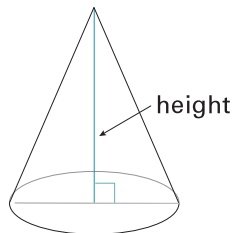

right cone

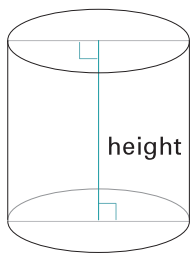

right cylinder

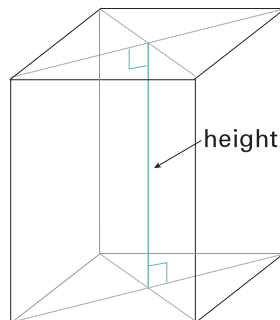

right prism

See cone, cylinder, prism

## rigid

Not flexible. Stiff. A jointed structure is rigid when its angles cannot be changed (the struts will not move out of place).

A triangle forms a rigid structure.

*Examples*

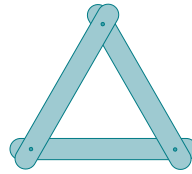

rigid shape

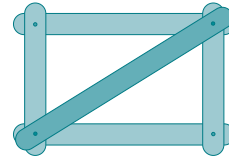

rigid shape

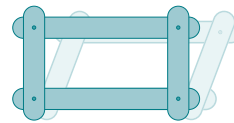

non-rigid shape (flexible)

See flexible

## rise

See gradient

## Roman numerals

An ancient system of numeration, where the numbers are represented by letters of the Roman alphabet.

The numerals are made up of a combination of these symbols.

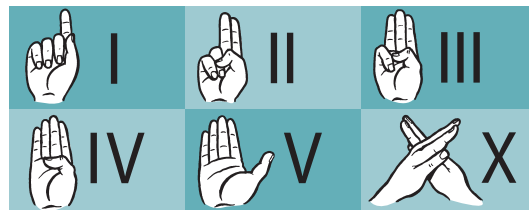

- |        |                |
|--------|----------------|
| I (1)  | C (100) centum |
| V (5)  | D (500)        |
| X (10) | M (1000) mille |
| L (50) |                |



*Examples*

2000 – MM

2002 – MMII

See numeration, see section Roman numerals on page 148

**rotate**

Move around an axis or centre. Revolve. Turn round and round.

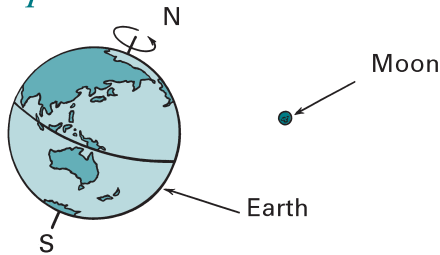
*Examples*

The Earth rotates around its axis.  
The Moon revolves around the Earth.

**rotation**

The process by which an object changes position by turning about a fixed point through a given angle.

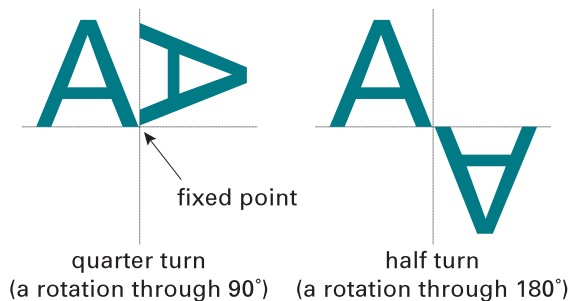
*Examples***rotational symmetry**

When a shape is turned through an angle less than 360° and remains the same, it has rotational symmetry.

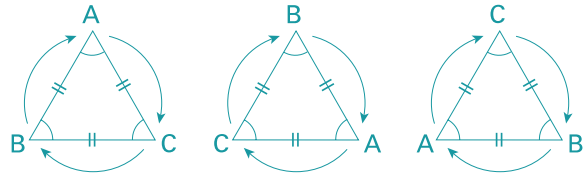
*Example*

An equilateral triangle has rotational symmetry.

**rounding**

Writing an answer to a given degree of accuracy.

*Example*

2764 rounded to the nearest ten becomes 2760  
rounded to the nearest hundred becomes 2800  
rounded to the nearest thousand becomes 3000

- (i) Numbers ending in 1, 2, 3 and 4 round down to the lower number.

*Examples*

54 rounded to the nearest ten becomes 50.  
348 rounded to the nearest hundred becomes 300.

- (ii) Numbers ending in 5, 6, 7, 8 and 9 round up to the higher number.

*Examples*

55 rounded to the nearest 10 becomes 60.  
356 rounded to the nearest 100 becomes 400.

See accurate, estimate, significant figure



**route**

A path. A way taken from start to finish, which may be traversed.

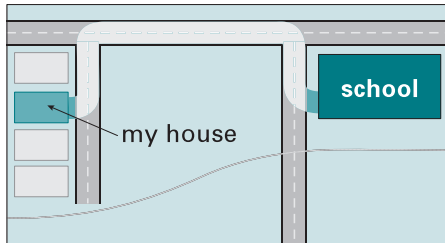
*Example*

My route to school

**row**

(i) A horizontal arrangement.

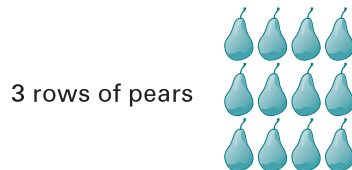
*Example*

3 rows of pears

(ii) Things arranged so that they make a line going from left to right.

*Example*

A row of numbers: 4, 5, 6, 7, 8, 9, ...

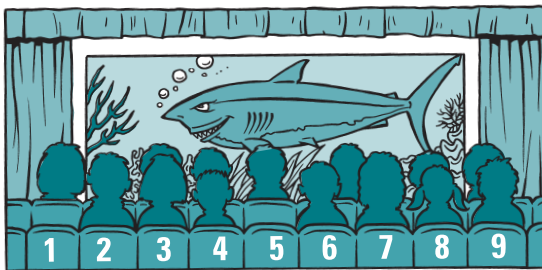

A row of seats in the theatre

See column, horizontal line

**rule**

(i) An instruction to do something in a particular way.

*Example*

Find the rule for this sequence.

$$\begin{array}{ccccccc} 1, & 4, & 7, & 10, & 13 \\ \underbrace{\quad} & \underbrace{\quad} & \underbrace{\quad} & \underbrace{\quad} \\ +3 & +3 & +3 & +3 \end{array}$$

The rule is 'add 3'.

(ii) Numbers in a relation are following a rule.

*Example*

$t$	1	2	3	4	5	6
$D$	15	30	45	60	75	90

The rule is  $D = 15t$

(iii) To draw a line using a ruler.

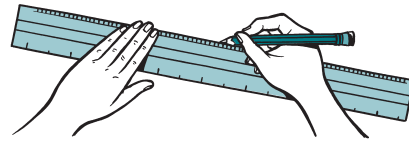
*Example*

See cycle game, number machine, progression, sequence

**ruler**

An instrument for drawing straight lines, usually made of plastic or wood. It has a scale for measuring length.

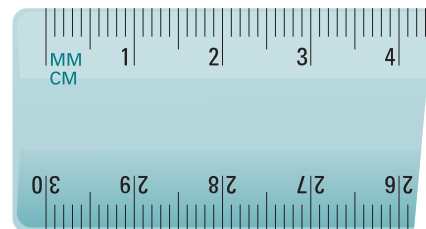

See graduated, scale

**run**

See gradient



## s

Symbol for second.

## same

Identical, alike, unchanged, not different.

### Example

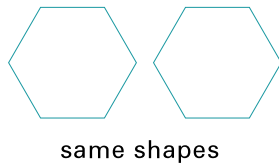

See congruent

## sample

A selection of a few items taken from a larger set.

### Example



In a biscuit factory they take a sample of each batch of biscuits.

## satisfy

In mathematics it means 'make the equation true'.

### Example

If  $x < 5$ , which of the numbers 8, 3, 35 or 4 satisfy the inequation?

Answer: 3 and 4, because  $3 < 5$  and  $4 < 5$ .

## scale

- (i) A thermometer, a ruler and a balance each have a scale marked on them to measure temperature, length and mass, respectively.

### Examples

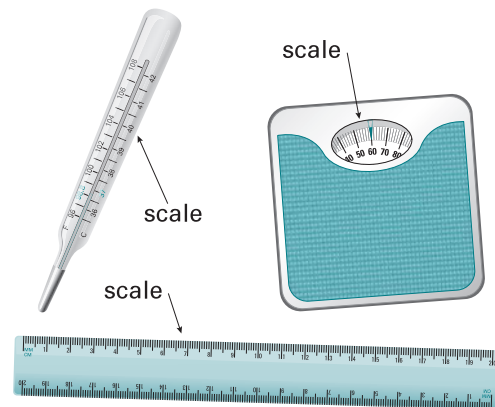

- (ii) A number line used on a graph.

### Example

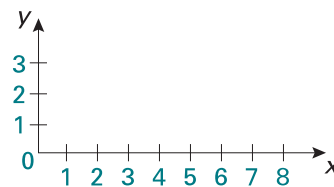

- (iii) The scale on a map or a plan shows the ratio for making things larger or smaller.

### Example

#### SCALE OF KILOMETRES

1 cm = 10 km

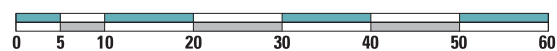

1: 1 000 000

See balance, enlargement, graph, number line, reduce, ruler, thermometer



## scale drawing

A drawing or plan on which the real object is made bigger or smaller while keeping the same proportions.

### Example

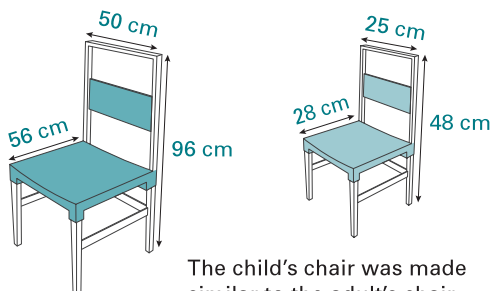

The child's chair was made similar to the adult's chair on a scale of 1 to 2 or 1 : 2.

See proportion

## scalene triangle

A triangle with each side different in length.

### Example

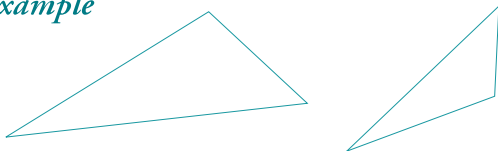

See triangle

## scales

Instruments used for finding or comparing weights or masses.

### Examples



spring balance for measuring weight

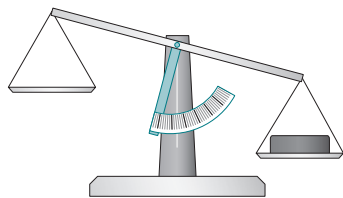

a balance for measuring and comparing masses



a balance for comparing masses



bathroom scales

See mass, weight

## scientific notation

A shorthand way of writing very large or very small numbers using powers of ten.

### Examples

(i)  $6\,300\,000 = 6.3 \times 1\,000\,000$   
 $\phantom{6\,300\,000} = 6.3 \times 10^6$   
 6 places

(ii)  $0.000\,567 = 5.67 \times 0.000\,1$   
 $\phantom{0.000\,567} = 5.67 \times 10^{-4}$   
 4 places

See expanded notation, index notation

## score

The amount of points or marks gained in a competition or test.

### Example

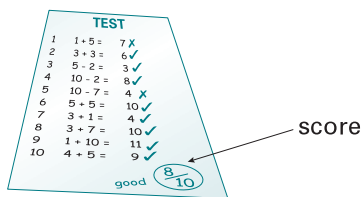

See average, mean, median, mode

## second

(i) second (2nd): The ordinal number which comes after first (1st) and before third (3rd).

### Example

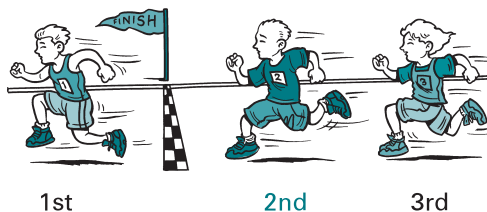

See ordinal number

(ii) second (symbol: s): A measurement of time. There are sixty seconds in one minute.

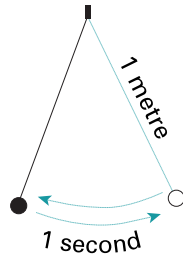
**Example**

One second is the time taken by a pendulum about one metre long to make one complete swing, over and back.

See pendulum

- (iii) second in angle measurement (symbol: "). A second is  $\frac{1}{60}$  of a minute, which is  $\frac{1}{60}$  of a degree.

See degree

**section**

- (i) A flat surface obtained by cutting through a solid in any direction.

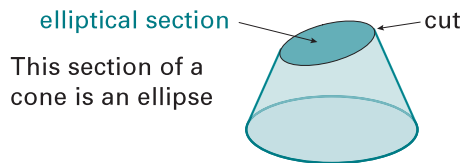
**Example**

This section of a cone is an ellipse

- (ii) When the cut is parallel to the base of the solid, it is called a cross-section.

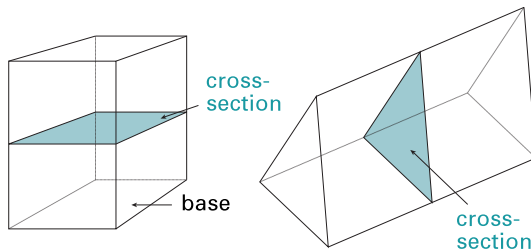
**Example**

See cone, cross-section of a solid, ellipse, flat, frustum, segment, solid, surface

**sector graph**

See pie graph

**segment**

A part, a section of something.

**Examples**

- (i) A line segment

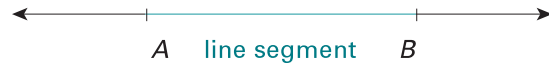

- (ii) A segment of a circle is the part of the circle between an arc and its chord.

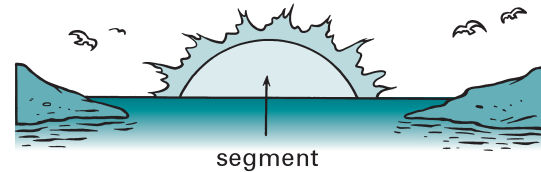
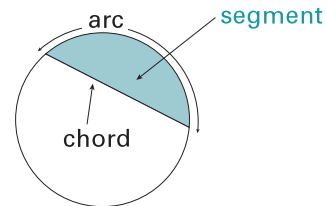

See arc, chord

**selling price**

Price at which something is sold.

**Example**

A car dealer sells a car for \$12 000. The selling price of the car is \$12 000.

See cost price, loss, profit

**semicircle**

Half a circle.

When you cut a circle along its diameter, you get two semicircles.

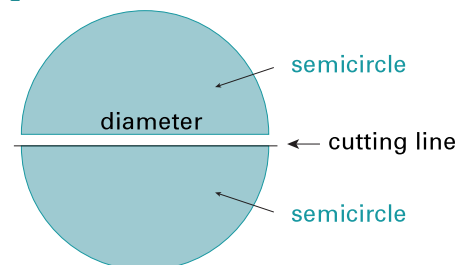
**Example**

See circle, diameter



**sentence**

A statement. In mathematics a sentence may contain pronumerals, numerals and other symbols.

See false sentence, number sentence, numeral, open number sentence, pronumeral, symbol, true sentence

**sequence**

A pattern, following an order or rule.

*Examples*

(i) 1, 3, 5, 7, ...

The rule of this sequence is 'add 2'.

(ii)



In this sequence each shape is following a pattern of rotation anticlockwise by the same amount of turn.

See anticlockwise, order, pattern, progression, rotation, rule

**seriate**

To put in order.

*Example*

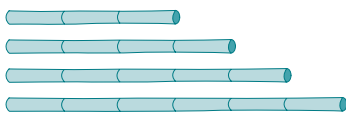

These sticks are seriated according to length.

**set**

(Symbol: { })

A group of objects or numbers. Each object in a set is called a member or an element of the set. The elements of a set are written inside braces { }.

*Example*

Set of whole numbers = {0, 1, 2, 3, 4 ...}

See braces, cardinal number, element of a set, subset, whole numbers

**set square**

An instrument used for geometrical drawings, made of wood, plastic or metal.

*Examples*

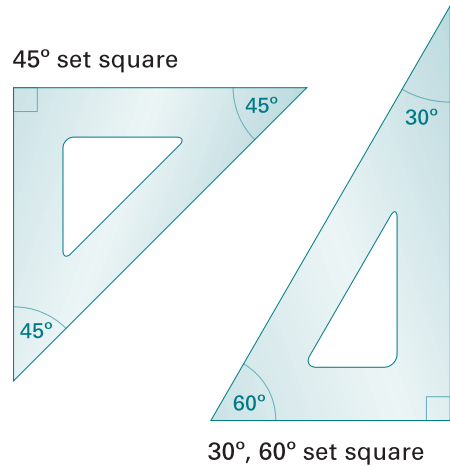

Set squares are used for drawing parallel lines, right and other angles, etc.

See parallel lines, right angle

**shadow stick measuring**

A useful, old method for calculating heights that cannot be directly measured. It is based on the properties of similar triangles.

*Example*

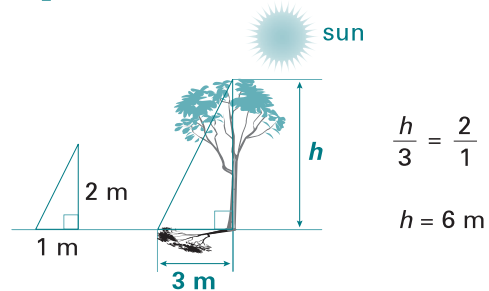

We measure the shadow of a stick of a known length and the shadow cast by the tall object. The length of the stick and the object, and their shadows, are in the same ratio.

See ratio, similar

## shape

The form of an object.

### Examples

2D shapes: triangles, quadrilaterals

3D shapes: cubes, prisms, pyramids

See cube, dimension, prism, pyramid, quadrilateral, three-dimensional, triangle, two-dimensional

## sharing

See division

## SI

The international metric system.

The symbol SI comes from the initials of the French term *Système Internationale d'Unités* (international unit system).

This system is based on the metre, gram, second, ampere, kelvin, candela and mole.

See metric system

## side

A line segment which is a part of a perimeter or of a figure.

### Examples

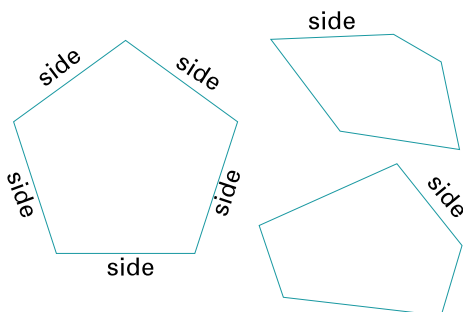

A pentagon has five sides.

See line segment, pentagon, perimeter, regular polygon

## side view

A diagram, as seen from the side.

### Example

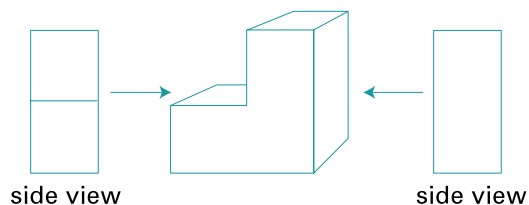

See cross-section of a solid, front view, plan

## sign

A symbol used to show an operation or a statement.

### Examples

Addition sign +

Subtraction sign −

Multiplication sign ×

Division signs ÷,  $\frac{\quad}{\quad}$ ,  $\overline{\quad}$

Equal sign =

See operation, symbol, see section List of symbols on page 147

## significant figure

A digit in a number that is considered important when rounding off or making an approximation.

### Examples

3745 rounded to two significant figures is 3700.

0.165 of a metre rounded to one significant figure is 0.2 of a metre.

See approximately, rounding



## similar

The same in shape but not in size.

Two shapes are similar if the corresponding angles are equal and all sides are enlarged or reduced in the same ratio.

### Examples

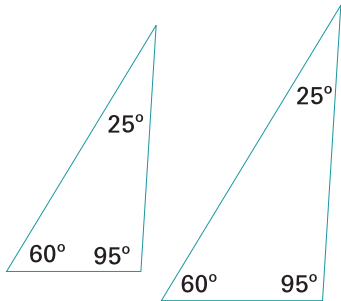

similar triangles

See congruent, enlargement, ratio, reduce

## simple fraction

A fraction such as  $\frac{3}{4}$ ,  $\frac{1}{2}$ ,  $\frac{7}{10}$ .

Also called a common, proper or vulgar fraction.

### Example

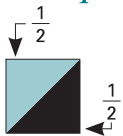

One whole has been divided into two equal parts (halves)

- 1 ← number of parts taken from the whole (numerator)
- 2 ← number of parts the whole has been divided into (denominator)

See denominator, fraction, numerator

## simple interest

Interest payable on the principal alone is called simple interest. The interest is charged each year for the period of the loan.

### Example

John borrows \$1000 from his bank to buy a guitar at a simple interest rate of 6 per cent over a period of 5 years.

John has to pay  $\frac{6}{100} \times \$1000 = \$60$  each year.

John has to pay a total amount of interest of  $\$60 \times 5 = \$300$  on the loan.

See interest, interest rate, principal

## simplify

Make simple. Write in the shortest, simplest form.

### Examples

Simplify	$\frac{8}{10} + \frac{4}{20}$	Simplify	$\frac{a^2b}{ab}$
	$= \frac{4}{5} + \frac{1}{5}$		$= \frac{a \times a^1 \times b^1}{a_1 \times b_1}$
	$= \frac{5}{5}$		$= a$
	$= 1$		

See cancelling

## simultaneous equations

Equations that have the same unknown quantities and are solved together.

### Example

$$\begin{aligned} a + b &= 10 \\ 2a &= 6 \quad \Rightarrow \quad a = 3 \checkmark \end{aligned}$$

$$\begin{aligned} 3 + b &= 10 & \text{Check:} \\ b &= 10 - 3 & a + b = 10 \\ b &= 7 \checkmark & 3 + 7 = 10 \checkmark \end{aligned}$$

The solution is  $a = 3$  and  $b = 7$ .

## size

The amount, magnitude or dimension.

### Examples

- (i) The size of this angle is  $37^\circ$ .

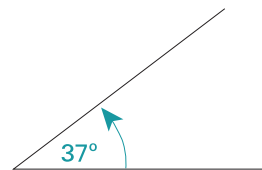

- (ii) Helen wears size ten clothes and size two shoes.

## skew lines

Lines that do not lie in the same plane; they cannot intersect and are not parallel.

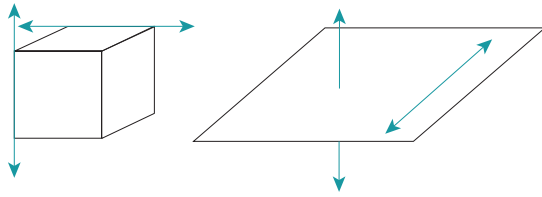

**Examples**

See intersect, parallel lines

**slide**

Change position on the surface.

See flip, rotation, translation, turn

**slope**

The slope of a line measures the steepness of the line. Slope is calculated by  $\frac{\text{rise}}{\text{run}}$  (rise over run).

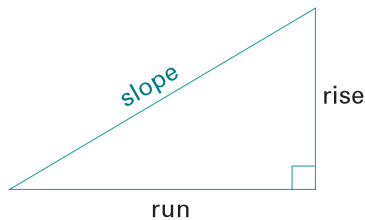
**Example**

See gradient, tangent ratio

**solid**

A solid is a figure with three dimensions, usually length, width and height (depth).

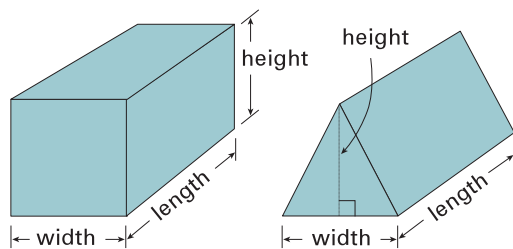
**Examples**

See height, length, three-dimensional, width

**solution**

The answer to a problem or question.

**Example**

The equation  $x + 4 = 9$

has a solution  $x = 5$ .

**solve**

Find the answer.

See calculate, solution

**some**

Not all of the whole. At least one.

**Examples**

(i)



a whole cake

some of the cake

(ii) Some of the children are walking away.

**sorting**

Putting objects into groups according to attributes.

**Example**

	green	not green
thick		
not thick (thin)		

Attributes are colour and thickness.

See attribute, Carroll diagram, classification, classify, group



## space

Space is a three-dimensional region.  
Spatial figures (solids) have three dimensions.  
*See* dimension, region, solid, three-dimensional

## span

Stretch from side to side, across.  
*See* handspan

## spatial

Things which are relating to, or happening in, space.

## speed

The rate of time at which something travels.  
The distance travelled in a unit of time.

### Example



A car travelled sixty kilometres in one hour.  
Its speed was 60 km/h.

*See* distance, knot, unit of measurement

## sphere

A three-dimensional shape like a round ball.  
A sphere has one curved surface and no corners or edges. Every point on the sphere's surface is the same distance from the sphere's centre.

### Examples



a basketball



the Earth

*See* three-dimensional

## spinner

A disc marked with numbers used in chance games.

### Examples

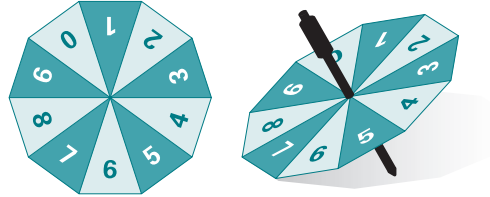

## spiral

A curve like a coil on a flat surface.

### Example

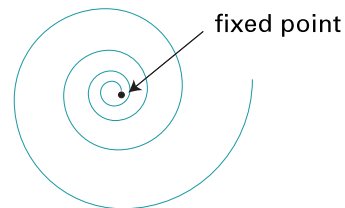

A spiral is a continuous curve moving around a fixed point so that its distance from the fixed point is always increasing.

*See* curve, distance

## spring balance

An instrument that measures weight.

A spring inside it is extended by the force equal to the mass of the object.



*See* mass, weight

## square

A quadrilateral with four equal sides and four right angles.

### Example

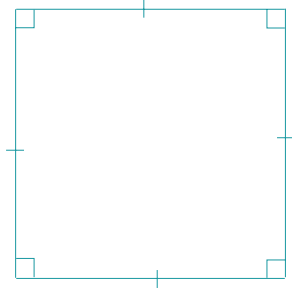

See quadrilateral, right angle

## square centimetre

(Symbol:  $\text{cm}^2$ )

A square centimetre is a unit for measuring area.

### Examples

The area is one square centimetre.



The area of this shape is three square centimetres.

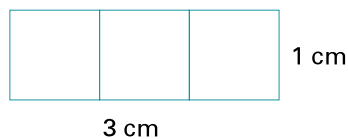

$$3 \text{ cm} \times 1 \text{ cm} = 3 \text{ cm}^2$$

See area, unit of measurement

## square kilometre

(Symbol:  $\text{km}^2$ )

A unit for measuring very large areas.

$$1 \text{ km}^2 = 1\,000\,000 \text{ m}^2$$

### Examples

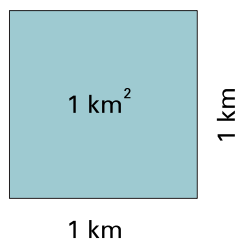

The area of the Northern Territory is  $1\,346\,200 \text{ km}^2$ .



Smaller areas, like the sizes of towns or suburbs, are measured in hectares.

$$1 \text{ km}^2 = 100 \text{ ha}$$

See area, hectare, unit of measurement

## square metre

(Symbol:  $\text{m}^2$ )

A unit for measuring area.

$$1 \text{ m}^2 = 10\,000 \text{ cm}^2$$

### Examples

- (i) This man is holding a piece of cardboard which has an area of one square metre.

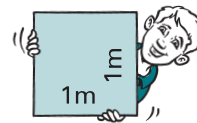

- (ii) This rug has an area of  $4.5 \text{ m}^2$ .

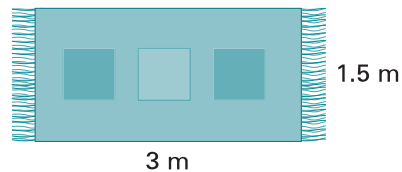

See area, square centimetre, unit of measurement

## square number

A number that can be represented by dots in the shape of a square.

### Examples



4



9



16

See index, index notation, triangle number



## square of a number

The answer you get when you multiply a number by itself.

### Examples

$$2^2 = 2 \times 2 = 4$$

$$3^2 = 3 \times 3 = 9$$

$$(0.5)^2 = 0.5 \times 0.5 = 0.25$$

See index, index laws, square root

## square paper

Paper ruled in squares, used for scale drawing and graphing.

### Examples

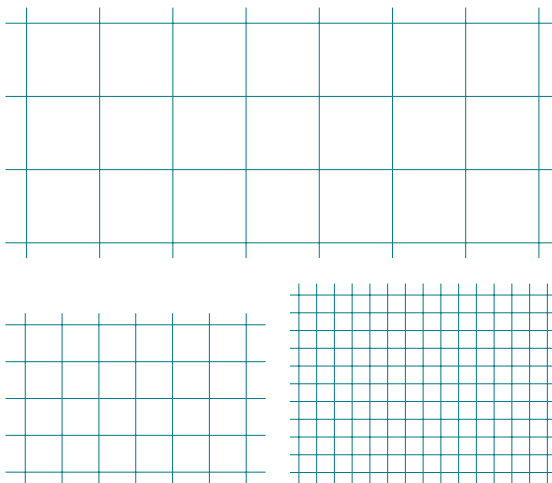

See dot paper, graph, isometric paper, scale drawing

## square root

A number which, when multiplied by itself, produces the given number.

The inverse operation of squaring a number.

### Examples

$$\sqrt{2} \times \sqrt{2} = 2$$

$$\sqrt{9} \times \sqrt{9} = 9$$

$$+2^2 = 2 \times 2 = +4$$

$$(-2)^2 = -2 \times -2 = +4 \} \therefore \sqrt{4} = \pm 2$$

See square of a number

## standard unit

Units of measure that are internationally accepted by agreement are said to be 'standard measures'; for example, the metric measures.

See SI, unit, unit of measurement

## statistics

The study concerned with the collection and classification of numerical facts. The information collected is called data. Data can be represented in a table or on a graph, and interpreted and analysed.

### Example

FAVOURITE FOODS			
Meat	Vegetables	Fruit	Sweets
Paul S.	Carlo	Anne	Dean
John	Hirani	James	Belinda
Tibor		Paul B.	Quong
Jackie		Claire	Brad
Toula		Ranjit	Ali
Sarah			Anna
David			Jhiro
Jeremy			Peter
			Samantha
			Halima

The information in the table is the data. There are 25 children in the class.

8 children prefer meat

$$\therefore \frac{8}{25} \times \frac{100}{1} = 32\% \text{ of the class prefer meat}$$

2 children prefer vegetables

$$\therefore \frac{2}{25} \times \frac{100}{1} = 8\% \text{ of the class prefer vegetables}$$

5 children prefer fruit

$$\therefore \frac{5}{25} \times \frac{100}{1} = 20\% \text{ of the class prefer fruit}$$

10 children prefer sweets

$$\therefore \frac{10}{25} \times \frac{100}{1} = 40\% \text{ of the class prefer sweets}$$

The percentages are statistics about the food preferences of the class.

See data, per cent





(ii) Difference (comparison).

*Example*

Remy has seven pencils and Robin has three pencils. How many more pencils has Remy than Robin?

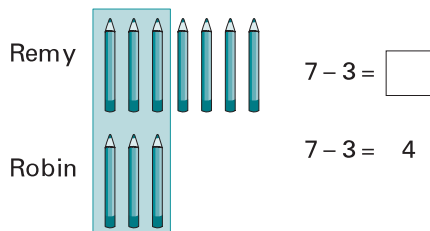

Remy has 4 more pencils than Robin.

(iii) Complementary addition (missing addend, counting on).

*Example*

Rowan has three pencils, but needs seven. How many more must he get?



Rowan must get 4 more pencils.

Subtraction may be represented on a number line.

*Example*

Show on the number line:

$5 - 3 = 2$

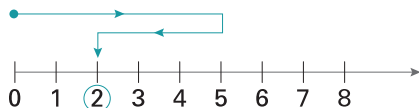

See complementary addition, difference, number line

**subtrahend**

A number which is to be subtracted from another number.

*Example*

$$\begin{array}{rccccccc} 12 & - & 4 & = & 8 \\ \uparrow & & \uparrow & & \uparrow \end{array}$$

minuend subtrahend difference

Four is the subtrahend.

See difference, minuend, subtract

**sum**

The answer to an addition problem. It is the total amount resulting from the addition of two or more numbers (called addends), quantities or magnitudes.

*Example*

$$\begin{array}{rccccccc} 3 & + & 4 & = & 7 \\ \uparrow & & \uparrow & & \uparrow \\ \text{addends} & & & & \text{sum} \end{array}$$

Seven is the sum.

See addend, addition

**supplementary angles**

Two angles which together make  $180^\circ$ .

*Example*

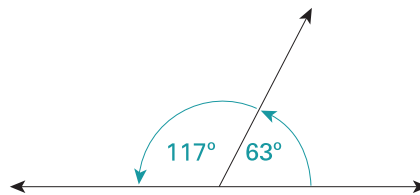

Angles  $117^\circ$  and  $63^\circ$  are supplementary.

Angle  $117^\circ$  is called the supplement of  $63^\circ$ .

Angle  $63^\circ$  is called the supplement of  $117^\circ$ .

See complementary angles, parallel lines



**surface**

(i) The outside of something.

*Example*

The surface of the tennis ball is furry.

(ii) The top level of a liquid.

*Example*

Leaves float on the surface of a lake.

The surface of an object may be flat or curved.

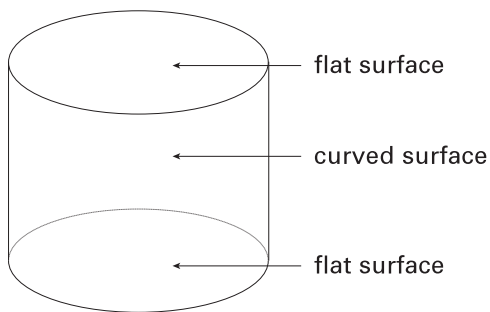
*Example*

A cylinder has two flat surfaces and one curved.

*See area, cylinder*

**surface area**

The total area of the outside of a 3D shape.

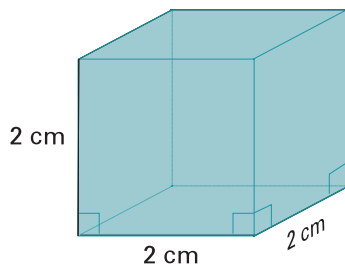
*Example*

A cube with two centimetre sides has a surface area of

$$6 \times (2 \times 2) \text{ cm}^2 = 24 \text{ cm}^2$$

*See area, cube, surface*

**symbol**

A letter, numeral or mark which represents something. We do not write a full stop after a symbol.

*Examples*

1	2	3	+	-	×	÷
=	≠	>	<	≈	%	□
cm	kg	ha	m <sup>3</sup>	∠		
a	b	x <sup>2</sup>	2x			

*See abbreviation, place holder, pronomeral, see section Useful information pages 146–7*

**symmetry**

A shape has symmetry or is symmetrical when one half of the shape can fit exactly over the other half.

Shapes are called symmetrical if they have one or more lines (axes) of symmetry.

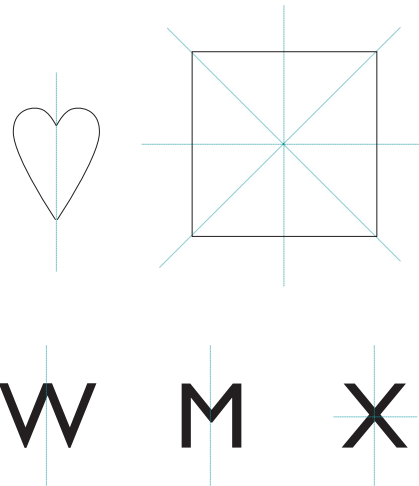
*Examples*

*See asymmetry, axis, line of symmetry, rotational symmetry*

**Système Internationale d'Unités**

*See SI*

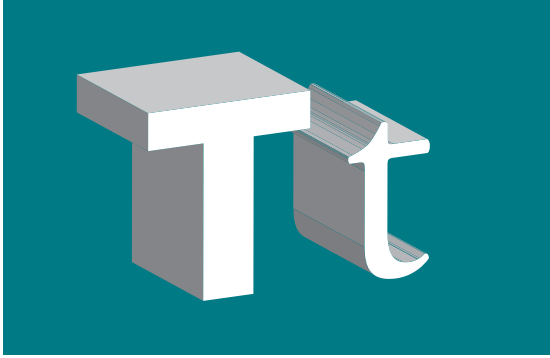

**t**

Symbol for tonne.

**table**

- (i) An arrangement of letters or numbers in rows or columns.

*Example*

×	1	2	3	4	5	6
1	1	2	3	4	5	6
2	2	4	6	8	10	12
3	3	6	9	12	15	18
4	4	8	12	16	20	24
5	5	10	15	20	25	30
6	6	12	18	24	30	36

- (ii) When multiplication facts are arranged in order, they are then called multiplication tables.

*Example*

The tables of nine

$$1 \times 9 = 9 \qquad 6 \times 9 = 54$$

$$2 \times 9 = 18 \qquad 7 \times 9 = 63$$

$$3 \times 9 = 27 \qquad 8 \times 9 = 72$$

$$4 \times 9 = 36 \qquad 9 \times 9 = 81$$

$$5 \times 9 = 45 \qquad 10 \times 9 = 90$$

See multiplication

**take away**

Remove, subtract. It is one method of subtraction.

*Example*

I had fifteen marbles and I lost seven.

How many do I have now?

$$15 - 7 = 8 \text{ (take away seven from fifteen)}$$

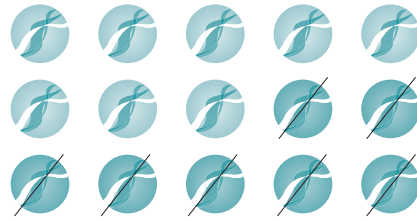

Answer: I have eight marbles now.

See subtraction

**tally**

A record of items made by placing a mark to represent each item. The marks are usually drawn in groups of five, with the fifth mark in each group crossing the other four, to make them easy to count.

*Example*

A tally of 13 items

|||| |

**tangent ratio**

(Symbol: tan)

In right-angled triangles the terms opposite and adjacent always refer to the two shorter sides. The longest side is called the hypotenuse.

The side opposite angle  $A$  is called 'opposite side'. The side adjacent to angle  $A$  is called 'adjacent side'. The side opposite the right angle is called 'hypotenuse'.

The ratio  $\frac{\text{opposite side}}{\text{adjacent side}} = \tan A$

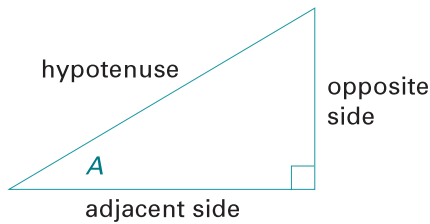

*Example*

See gradient, right-angled triangle, Pythagoras' theorem

**tangram**

A Chinese puzzle made up of a square cut into seven pieces that can be rearranged to make many varied shapes.

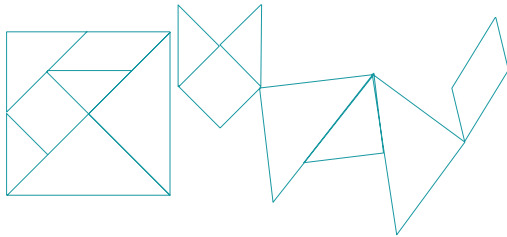
*Example***tape measure**

A strip of tape or thin metal marked with centimetres.

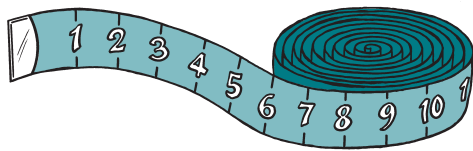
**tare**

Mass of packaging in which goods are packed.

See gross mass

**temperature**

How hot or how cold something is.

Temperature is measured in degrees Celsius ( $^{\circ}\text{C}$ ).

*Examples*

- (i) Water freezes (changes to ice) at  $0^{\circ}\text{C}$ .

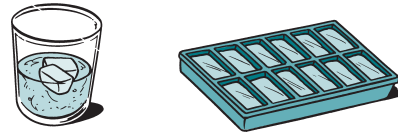

- (ii) Water boils at  $100^{\circ}\text{C}$ .

- (iii) Normal body temperature is about  $37^{\circ}\text{C}$ .

See degree Celsius, thermometer

**template**

An instrument for drawing shapes. It may be one of two types:

- (i) Cardboard or plastic pieces around which we draw.

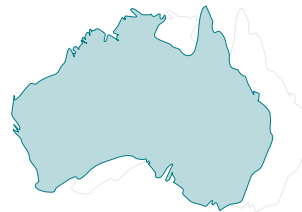
*Example*

- (ii) A sheet of cardboard or firm plastic out of which shapes have been cut.

*Example*

template

**term**

- (i) Each of two quantities in a ratio or a fraction.

*Example*

$$\frac{3}{4} \quad 1:7$$

▼ **term continued...**



- (ii) Each of the quantities connected by + or – in an algebraic expression or equation.

*Example*

$$3a - 3b \quad y = x + 1$$

## terminate

To come to an end, finish, not to go any further.

## terminating decimal

A decimal fraction that is not recurring, that has ‘an end’.

*Example*

$$\frac{1}{4} = 0.25$$

$$\begin{array}{r} 0.25 \\ 4 \overline{)1.00} \\ \underline{-8} \phantom{0} \\ 20 \\ \underline{-20} \\ 0 \end{array} = (\text{end})$$

*See* recurring decimal

## tessellation

A complete covering of a plane by one or more figures in a repeating pattern, with no overlapping of, or gaps between, the figures. Mosaic and pavement shapes tessellate.

*Examples*

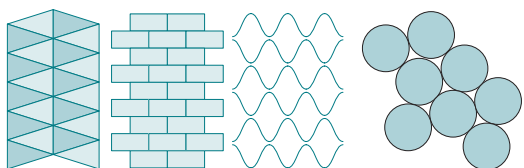

These shapes tessellate.

Circles do not tessellate.

Certain shapes will cover a surface completely: squares, equilateral triangles, hexagons, etc. These are said to ‘tessellate’.

*See* circle, pattern, plane, square, triangle

## tetragon

A plane shape with four sides and four angles.

*See* quadrilateral

## tetrahedron

A solid (polyhedron) with four faces. Also called a triangular pyramid.

A regular tetrahedron is made of four congruent equilateral triangles and belongs to the group called platonic solids.

*Examples*

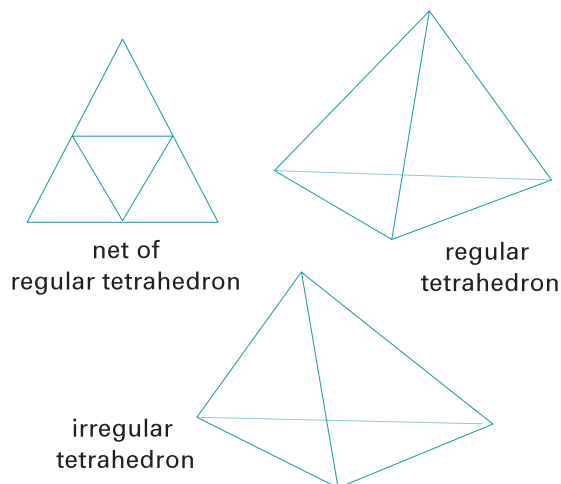

net of regular tetrahedron

regular tetrahedron

irregular tetrahedron

*See* polyhedron, regular polyhedron

## thermometer

An instrument for measuring temperature.

*Example*

This thermometer shows a temperature of 100 °C.

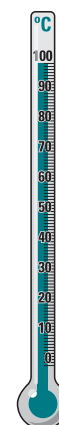

*See* degree Celsius, temperature

## third

- (i) The ordinal number which comes after second and before fourth.

### Example



1st      2nd      3rd      4th

- (ii) One third means one of three equal parts. Written as  $\frac{1}{3}$ .

### Example

$\frac{1}{3}$  has been coloured in

$\frac{1}{3}$	$\frac{1}{3}$	$\frac{1}{3}$
---------------	---------------	---------------

See ordinal number

## thousand

Ten hundreds, written as 1000.

See hundred

## thousand separator

For easy reading, large numbers are divided into groups of three digits either side of the decimal point.

### Example

26 375 159.123 45

The correct separator is a narrow space between the groups of digits, as shown, not the comma that was used in the past.

## three-dimensional

(3D)

When something has length, width and height, that is, three dimensions, then it is three-dimensional. Space figures (solids) are three-dimensional.

### Example

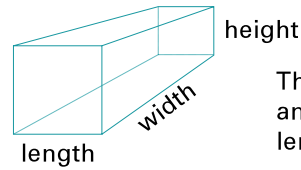

The sketch produces an illusion of depth, length and height.

See dimension, solid, sphere

## time interval

The time that passes between two events.

Some units of time are:

second s

minute min

hour h

day d

week, month, year, decade,  
century, millenium

See unit of measurement

## time line

A line on which intervals of time are recorded in chronological order.

### Example



See time interval



## times

(Symbol:  $\times$ )

A word used for multiplication.

### Examples

When we multiply  $3 \times 5$ , we say 'three times five'.

Also, in  $5(a + b)$ , we say 'five times  $(a + b)$ '.

## tonne

(Symbol: t)

A tonne is a metric unit for measuring mass.

$$1 \text{ t} = 1000 \text{ kg}$$

### Examples

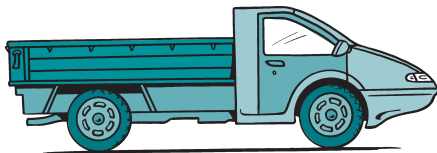

The mass of this empty utility is 1435 kilograms or 1.435 tonnes.



This water tank contains 1000 litres of water. The mass is 1000 kilograms or one tonne.

See kilogram, litre, mass, metric system

## topology

The part of mathematics that deals with non-measurable properties of things; of insides and outsides, surfaces, shapes and connections.

Topology is concerned with relative positions, not measurement.

### Example

Square  $ABCD$  can be distorted to look like this:

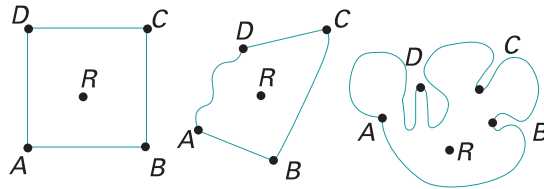

$R$  always remains inside the figure.

Topology is sometimes called 'rubber-sheet geometry'.

See property

## torus

A 3D shape, like a doughnut or a tyre tube.

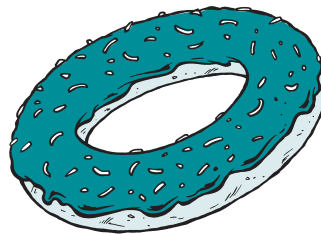

## total

- (i) Sum. When you add things or values together, the answer is the total.

### Example

$$10 + 20 + 25 = 55$$

↑  
total

- (ii) Whole.

### Example

The total area of the farm is 80 hectares.

See add, sum

## transformation

- (i) The process by which the shape, position or size of an object is changed.

See enlargement, flip, projection, reduce, reflection, rotation, translation



## tree diagram

A diagram that has a branch tree-like structure and shows all possible outcomes.

### Example

A family with three children. The first child could have been a girl or a boy, so could have the second and third child.

A tree diagram shows all possible outcomes as follows:

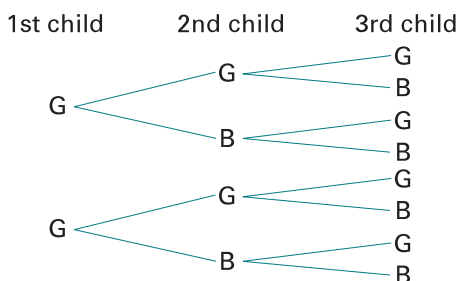

The sum of angles inside a triangle is always  $180^\circ$ .

See equilateral triangle, isosceles triangle, plane shape, right-angled triangle, scalene triangle, sum

## triangle number

(triangular number)

A number that can be represented by dots in the shape of a triangle.

### Examples

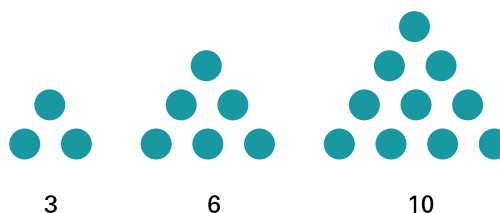

## triangle

A polygon with three sides and three angles. We can classify triangles by sides or by angles.

(i) By sides.

### Examples

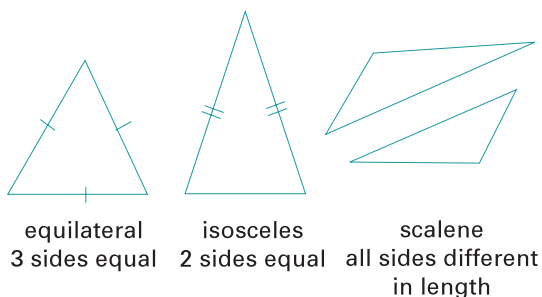

(ii) By angles.

### Examples

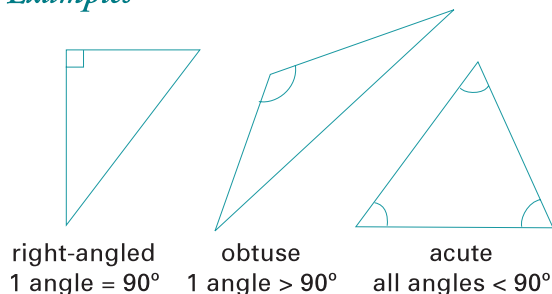

See triangle

## trillion

A trillion is a million millions, that is, 1 000 000 000 000, or  $10^{12}$ .

See section Large numbers on page 152

## true sentence

A sentence about numbers that is true or correct.

### Examples

$3 \times 2 = 2 \times 3$  is a true sentence.

$6 \neq 5$  is a true sentence.

The open number sentence  $2 + \square = 9$  becomes true, if  $\square$  is replaced by 7.

If  $\square$  is replaced by any other number, then it will become a false sentence.

See false sentence, number sentence, open number sentence



## trundle wheel

A wheel, usually one metre in circumference, used for measuring distance. The wheel often gives a click sound at each revolution (one metre), so the number of metres can be counted.

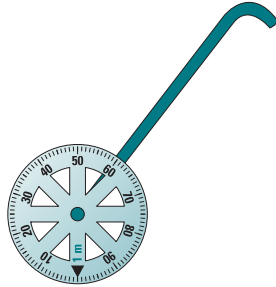

See circumference, metre

## turn

Move. Change position. Rotate.

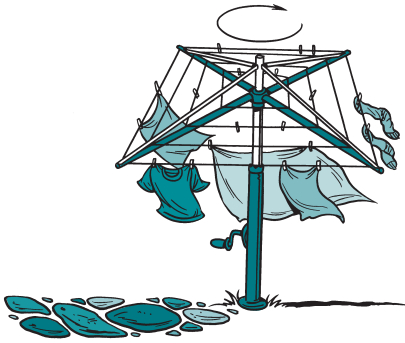

See rotation

## twelve-hour time

A period of one day (twenty-four hours) divided into two halves of twelve hours each. Twelve-hour time should include a.m. and p.m.

*Example*

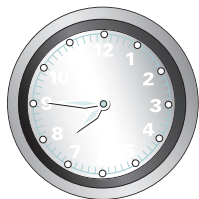

This clock shows either 7.45 a.m. or 7.45 p.m.

See a.m., p.m., twenty-four hour time

## twenty-four hour time

A period of one day divided into twenty-four hourly divisions, to prevent errors between a.m. and p.m. times.

*Example*

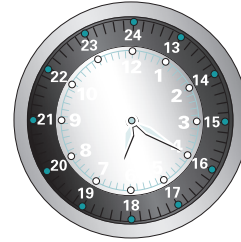

A 24-hour clock

12-hour time    24-hour time

1 a.m.            0100 one hundred hours

10 a.m.           1000 ten hundred hours

1 p.m.            1300 thirteen hundred hours

3.40 p.m.        1540 fifteen-forty hours

See a.m., p.m., twelve-hour time

## twice

Two times, or double.

*Example*

Twice six is  $2 \times 6 = 12$

## two-dimensional

(2D)

When something has length and width, then it has two dimensions and is two-dimensional. Plane shapes and surfaces have two dimensions.

*Examples*

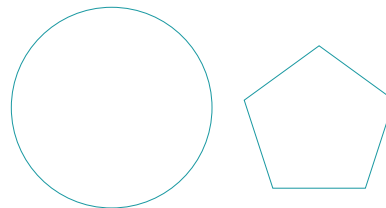

Plane regions have two dimensions.

See dimension, length, plane shape, region, surface, width





## unequal

(Symbol:  $\neq$ )

Not equal.

*Example*

$$3 \neq 4$$

Read as: 'Three is not equal to four'.

*See inequality, not equal*

## union

Combining two or more things.

## unit

Unit is another name for one.

The unit column in our number system refers to the first column to the left of the decimal point. In 425.0, the unit digit is 5.

*Example*

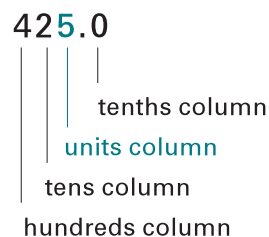

*See metric system, unit of measurement*

## unitary method

A simple way of solving problems, by working out the value of one unit.

*Example*

Five kilograms of grapes cost \$14.50. How much for three kilograms?

$$5 \text{ kg} = \$ 14.50$$

$$1 \text{ kg} = \frac{\$14.50}{5} = \$ 2.90$$

$$3 \text{ kg} = \$ 2.90 \times 3 = \$8.70$$

## unit, basic

Units, including those for mass, length and time, form the basis for a system of measurement.

*Example*

The metre, the kilogram and the second are base units of the metric system (SI).

*See section Metric relationships on page 149, metric system, unit of measurement*

## unit of measurement

A standard unit such as a kilometre, gram, minute, litre, etc.

*See standard unit*

## unit square

A square with sides of length equal to one unit of length or distance.

*Example*

A square with sides one metre long has an area of one square metre (1 m<sup>2</sup>).

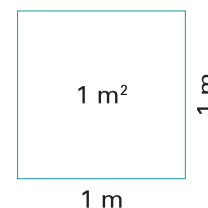

*See distance, unit of measurement*





## unknown value

In number sentences, algebraic expressions or equations, the unknown values are represented by pronumerals or variables.

### Examples

$$\begin{array}{cc} 2 \square = 10 & x - 7 \geq 5 \\ \uparrow & \uparrow \\ \text{unknown value} & \text{unknown value} \end{array}$$

$$\begin{array}{cc} 2a - 2b \\ \uparrow \quad \uparrow \\ \text{unknown values} \end{array}$$

See number sentence, pronumeral, variable

## unlike terms

Terms that are not like. Unlike terms cannot be combined or simplified by adding or subtracting.

### Examples

$$\begin{array}{cc} 2a + 3b & 2a + a \\ \uparrow \quad \uparrow & \uparrow \quad \uparrow \\ \text{unlike terms} & \text{like terms} \end{array}$$

See like terms





## V

Symbol for volume.

## value

- (i) When an expression is simplified, the result is the value of the expression.

*Example*

$$\begin{aligned} & \frac{3+5}{2} \times 7 \\ &= \frac{8}{2} \times 7 \\ &= 4 \times 7 \\ &= 28 \end{aligned}$$

28 is the value of  $\frac{3+5}{2} \times 7$

- (ii) When solving equations, we evaluate them.

*Example*

Find the value of  $\frac{x+5}{2}$ , if  $x = 10$ .

Answer:  $\frac{10+5}{2} = 7.5$

7.5 is the value.

- (iii) The amount of money something is worth.

*Example*

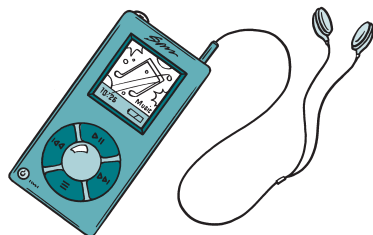

An MP3 player costs \$78. Its value is \$78.

*See equation, evaluate, place value*

## vanishing point

In perspective, the point or points at which all parallel lines appear to meet.

*Example*

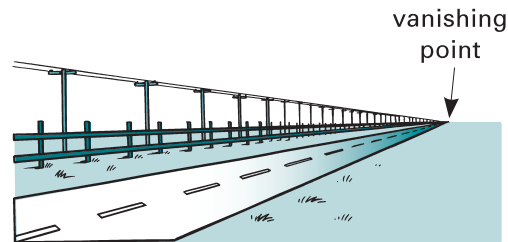

*See perspective*

## variable

- (i) A symbol or letter representing an unknown member of a set. In algebraic expressions, a variable stands for a value. Sometimes it is called an unknown.

*Example*

In  $x^2 + 3x + 2 = 0$ ,  $x$  is the variable.

- (ii) The same variable may have different values under different conditions.

*Example*

$$x + 3 = 5 \quad x = 2$$

$$x - 1 = 10 \quad x = 11$$

- (iii) A mathematical sentence that has at least one variable is called an open number sentence.

*Example*

$x + 3 = 7$  is true only when  $x = 4$ .

The number 4 is called the solution of  $x + 3 = 7$ .

If  $x$  is replaced by any other number, the sentence will become not true (false).

*See algebraic expression, constant, number sentence, open number sentence, place holder, pronumeral, symbol*

## Venn diagram

A diagram used to represent sets and relationships between sets.

*Example*

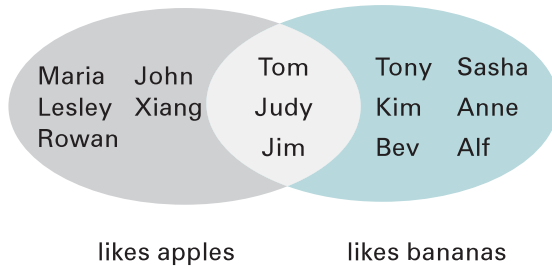

*See diagram, set*

## vertex

(Plural: vertices)

Top, the highest part or point.

A point where two or more adjacent lines meet to form an angle or a corner.

*Example*

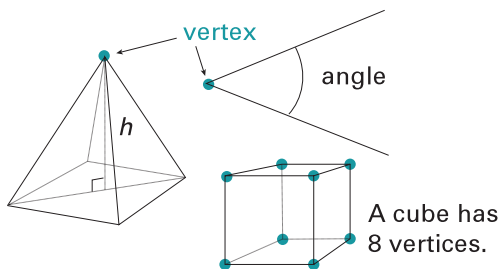

In plane or solid figures, the vertex is the point opposite the base.

*See apex, arm of an angle*

## vertical

A vertical line is perpendicular (at right angles) to the horizon.

*Examples*

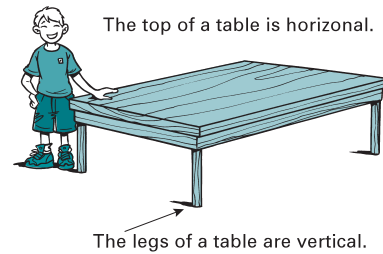
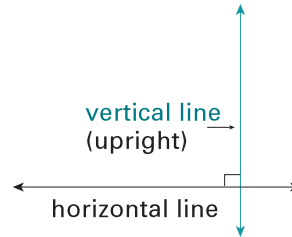

*See axis, horizon, horizontal line, perpendicular, right angle*

## vertically opposite angles

When two lines intersect, they make four angles at the vertex. The angles opposite each other are equal in size and are called vertically opposite angles.

*Example*

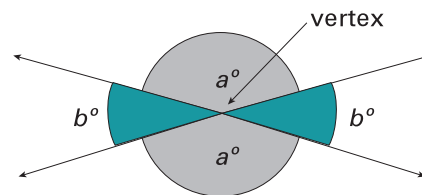

*See complementary angles, parallel lines, supplementary angles, vertex*



---

## volume

The amount of space inside a container, or the actual amount of material in the container.

### *Example*

The volume of this object is 36 cubic units.

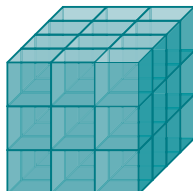

Some units of volume are:

- (i) For the volume of solids:
  - cubic centimetre**     $\text{cm}^3$
  - cubic metre**         $\text{m}^3$
- (ii) For the volume of liquids:
  - millilitre**             $\text{mL}$
  - litre**                     $\text{L}$
  - kilolitre**              $\text{kL}$
  - megalitre**             $\text{ML}$

*See capacity, cubic centimetre, cubic metre, cubic unit, section Metric relationships on page 149, solid*

---

## vulgar fraction

*See simple fraction*





Astronaut in space:  
his mass is still 75 kg  
but he is weightless.

## week

A period of time: seven days. There are fifty-two weeks in a year.

*See days of the week*

## weight

The pull of gravity on an object. The true meaning of the term 'weight' is a complicated physics problem. The weight of an object changes with the change of the gravitational pull. The mass of an object (the amount of matter the object is made of) remains constant.

### *Example*

Astronauts become weightless in space but the mass of their bodies does not change.

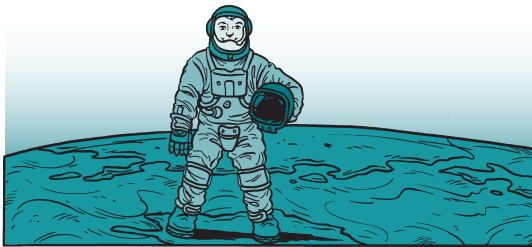

Astronaut on Earth:  
his mass = 75 kg  
his weight  $\approx$  75 kg

People often speak incorrectly of weight when they really mean mass.

*See mass*

## whole numbers

Zero together with all counting numbers.

{0, 1, 2, 3, 4, 5, 6, 7, 8, ...}

*See counting number, zero*

## width

The measurement from side to side. Also called breadth.

### *Example*

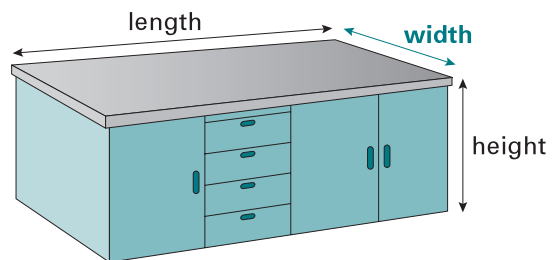

The width of this kitchen bench is 70 cm.



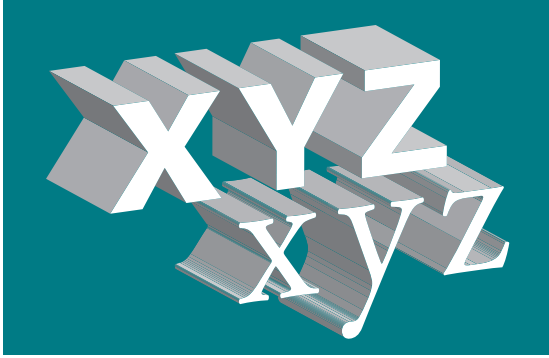

## x-axis, y-axis

See coordinates

## yard

An imperial measure of length.

$$1 \text{ yard} = 36 \text{ inches} \approx 90 \text{ cm}$$

## year

The period of time it takes the Earth to make one complete revolution around the sun: 365 days, 5 hours and  $48 \frac{3}{4}$  minutes. The extra hours, minutes and seconds are put together into an extra day every four years to form a 'leap year'.

See day, leap year, revolution

## zero

(Symbol: 0, Ø)

The numeral 0 (nought). Nothing.

Rules for working with zero:

1 A number + 0 = same number

$$5 + 0 = 5$$

2 A number - 0 = same number

$$7 - 0 = 7$$

3 A number  $\times$  0 = 0

$$6 \times 0 = 0$$

4  $0 \div$  any number = 0

$$0 \div 10 = 0$$

5 A number  $\div$  0 has no answer

$$3 \div 0 = \text{can't do}$$

The digit zero is used as a place holder in numerals.

### Example

In the number sixty, 0 is a place holder for units to show that the 6 means six tens and there are no single units.

Note: These words all mean zero: nil, nought, none, nix, null, oh, void, empty set, zilch, duck (in cricket), love (in tennis).

See digit, place holder

## zero power

When working with indices, any number raised to the power zero always equals one. It happens because when we divide indices, we subtract the indexes and get zero.

$$2^0 = 1 \quad 376^0 = 1 \quad x^0 = 1$$

### Example

Find the value of:

$$\begin{aligned} 5^2 \div 5^2 & & 5^2 \div 5^2 \\ = 5 \times 5 \div 5 \times 5 & & = 5^{(2-2)} \\ = 25 \div 25 & & = 5^0 \\ = 1 & & = 1 \end{aligned}$$

See index, index laws, power of a number





# Useful Information

## Units of measurement

### length

10 millimetres (mm)	= 1 centimetre (cm)
100 centimetres (cm)	= 1 metre (m)
1000 millimetres (mm)	= 1 metre (m)
1000 metres (m)	= 1 kilometre (km)

### area

100 square millimetres (mm <sup>2</sup> )	= 1 square centimetre (cm <sup>2</sup> )
10 000 square centimetres (cm <sup>2</sup> )	= 1 square metre (m <sup>2</sup> )
10 000 square metres (m <sup>2</sup> )	= 1 hectare (ha)
100 hectares (ha)	= 1 square kilometre (km <sup>2</sup> )
	= 1 000 000 square metres (m <sup>2</sup> )

### mass

1000 milligrams (mg)	= 1 gram (g)
1000 grams (g)	= 1 kilogram (kg)
1000 kilograms (kg)	= 1 tonne (t)

### liquid volume

1000 millilitres (mL)	= 1 litre (L)
1 mL (for liquids)	= 1 cm <sup>3</sup> (for solids)
1000 litres (L)	= 1 kilolitre (kL)
1 kL (for liquids)	= 1 m <sup>3</sup> (for solids)

### solids volume

1 cubic centimetre (cm <sup>3</sup> )
1 cubic metre (m <sup>3</sup> )

### time

60 seconds (s)	= 1 minute (min)
60 minutes (min)	= 1 hour (h)
24 hours (h)	= 1 day (d)
7 days	= 1 week
365 days	= 1 year
366 days	= 1 leap year
12 months	= 1 year
10 years	= 1 decade
100 years	= 1 century
1000 years	= 1 millenium

### symbols

m	metre
g	gram
L	litre
t	tonne
m <sup>2</sup>	square metre
m <sup>3</sup>	cubic metre
ha	hectare
°C	degree Celsius

**Remember:** These are the correct symbols.

mm	cm	m	km	
mL	L	kL		
mg	g	kg	t	
mm <sup>2</sup>	cm <sup>2</sup>	m <sup>2</sup>	ha	km <sup>2</sup>
cm <sup>3</sup>	m <sup>3</sup>			
s	min	h	d	

### angle measure

1 degree (1°)	= 60 minutes (60')
1 minute (1')	= 60 seconds (60'')
1 right angle	= 90 degrees (90°)
1 straight angle	= 180 degrees (180°)
1 revolution	= 360 degrees (360°)
1 radian	= approx 57.3 degrees (57.3°).



## A list of symbols

Symbol	Meaning	Example
+	addition sign, add, plus	$2 + 1 = 3$
-	subtraction sign, subtract, take away, minus	$7 - 6 = 1$
×	multiplication sign, multiply by, times	$3 \times 3 = 9$
$\div$ $\overline{) \quad}$	division sign, divide by	$9 \div 2 = 4.5$
=	is equal to, equals	$2 + 2 = 1 + 3$
≠	is not equal to	$2 \neq 5$
$\doteq \approx \cong$	is approximately equal to	$302 \approx 300$
$\leq$	is less than or equal to	$x \leq 12$
$\geq$	is greater than or equal to	$5 \geq y$
>	is greater than	$7 > 6.9$
<	is less than	$2 < 4$
$\nless$	is not less than	$6 \nless 5$
$\ngtr$	is not greater than	$3.3 \ngtr 3.4$
c	cent(s)	50c
\$	dollar(s)	\$1.20
.	decimal point (on the line)	5.24
%	per cent, out of 100	50%
°	degree Celsius, degree (angle measure)	°C 35 °C 90°
'	minutes (angle measure)	5° 35'
' foot	feet (imperial system)	1' $\approx$ 30 cm
"	seconds (angle measure)	12°05'24"
" inch	inches (imperial system)	12" = 1'
$\sphericalangle \wedge$	angle	$\sphericalangle AOB \widehat{BOC}$
$\triangle$	triangle	$\triangle ABC$
	parallel lines, is parallel to	$AB \parallel CD$
$\equiv \parallel$	line segments of the same length	
$\perp$	right angle, 90°	
$\perp$	is perpendicular to, at 90°	
$\sqrt{\quad}$	square root	$\sqrt{4} = \pm 2$
$\sqrt[3]{\quad}$	cube root	$\sqrt[3]{27} = 3$
$\pi$	pi, $\pi \approx 3.14$	$C = 2\pi r$
$\equiv \cong$	is congruent to	$\triangle ABC \equiv \triangle DEF$

## Roman numerals



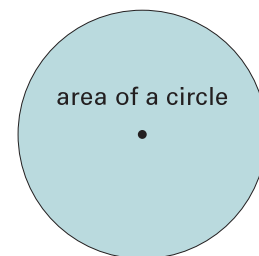
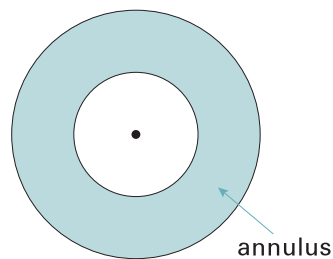
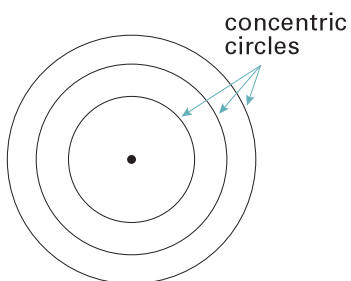
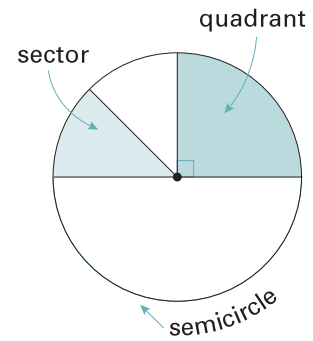
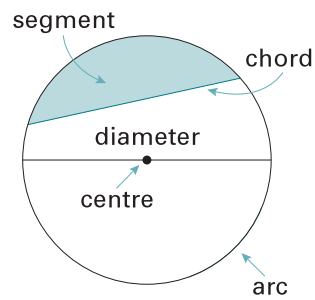
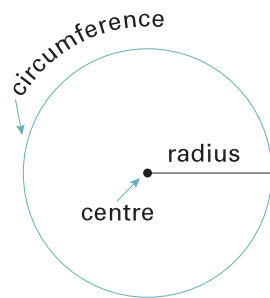

	Thousands	Hundreds	Tens	Units
1	M	C	X	I
2	MM	CC	XX	II
3	MMM	CCC	XXX	III
4		CD	XL	IV
5		D	L	V
6		DC	LX	VI
7		DCC	LXX	VII
8		DCCC	LXXX	VIII
9		CM	XC	IX

*Example*      2    0    0    7 = MMVII  
                   ↓    ↓    ↓    ↓  
                   MM            VII

## Parts of a circle

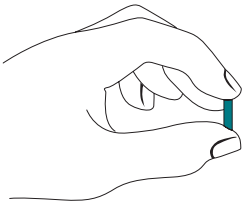
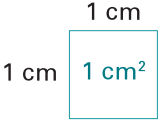
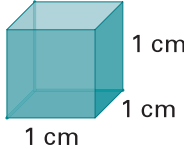
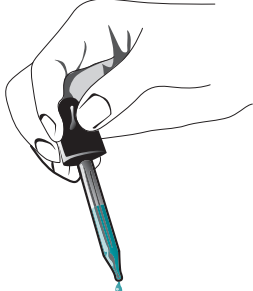
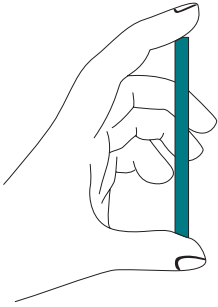
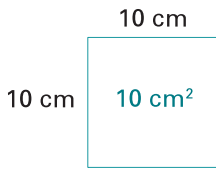
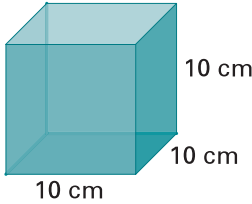
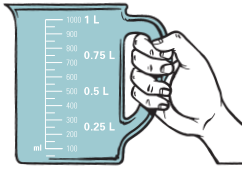

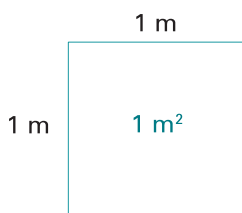
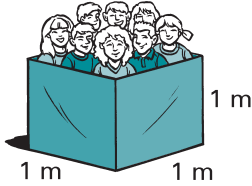
## Metric relationships

Length	Area	Volume	Capacity
			
1 cm 10 mm	$1 \text{ cm}^2$ $100 \text{ mm}^2$	$1 \text{ cm}^3$ $1000 \text{ mm}^3$	1 mL One 1 cm cube (cubic centimetre) has a capacity of 1 millilitre.
			
10 cm 100 mm	$100 \text{ cm}^2$ $10\,000 \text{ mm}^2$	$1000 \text{ cm}^3$ $1\,000\,000 \text{ mm}^3$	1 L One 10 cm cube ( $1000 \text{ cm}^3$ ) has a capacity of 1 litre.
			
1 m 100 cm	$1 \text{ m}^2$ $10\,000 \text{ cm}^2$	$1 \text{ m}^3$ $1\,000\,000 \text{ cm}^3$	1 kL One cubic metre has a capacity of 1 kilolitre. These 5 drums each hold 1 kilolitre.

## Formulae

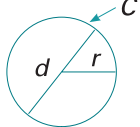
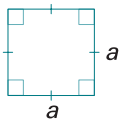
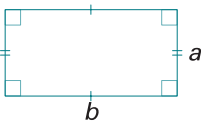
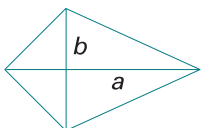
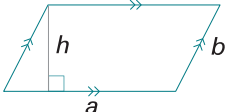
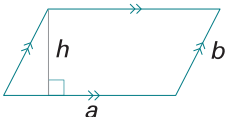
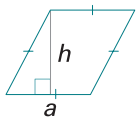
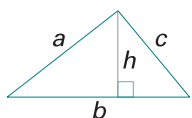
Plane shapes	Diagram	Area	Perimeter
circle		$A = \pi r^2$	$C = 2\pi r = \pi d$
square		$A = a^2$	$P = 4a$
rectangle		$A = ab$	$P = 2(a + b)$
kite		$A = \frac{ab}{2}$	
trapezium		$A = \frac{a + b}{2} \times h$	$P = a + b + c + d$
parallelogram		$A = ah$	$P = 2(a + b)$
rhombus		$A = ah$	$P = 4a$
triangle		$A = \frac{1}{2}bh$	$P = a + b + c$

## More formulae

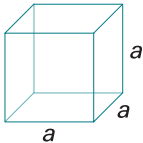
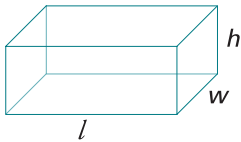
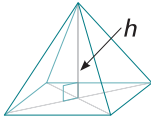
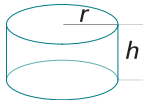
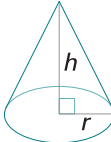
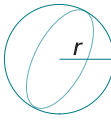
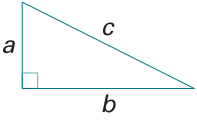
Solids	Diagram	Volume	Surface area
cube		$V = a^3$	$S = 6a^2$
cuboid		$V = lwh$	$S = 2(lw + bl + hw)$
pyramid		$V = \frac{1}{3} \text{base} \times h$	$S = \text{area of base} + 4 \times \text{Area of } \triangle$
cylinder		$V = \pi r^2 h$	$S = 2 \times \pi r^2 + 2\pi r h$ $= 2\pi r (r + h)$
cone		$V = \frac{1}{3} \pi r^2 h$	
sphere		$V = \frac{4}{3} \pi r^3$	$S = 4\pi r^2$
Pythagoras' theorem		$c^2 = a^2 + b^2$ $a = \sqrt{c^2 - b^2}$ $b = \sqrt{c^2 - a^2}$ $c = \sqrt{a^2 + b^2}$	

---

## Large numbers

million	$1000 \times 1000$	$10^6$
billion	1000 millions	$10^9$
trillion	1000 billions	$10^{12}$
quadrillion	million billions	$10^{15}$

---

## Letters used in mathematics

---

### in sets

I	integers
N	natural numbers
Q	rational numbers
R	real numbers
W	whole numbers

---

### in geometry

$a, b, c, d, \dots$	sides of polygons lengths of intervals names of lines
$A, B, C, D, \dots$	points, vertices
$A$	area of polygons
$b$	base of polygons
$C$	circumference of a circle
$d$	diameter of a circle
$h$	height
$l$	length
$O$	origin, centre of a circle
$P$	perimeter
$r$	radius of a circle
$s$	side
$S, SA$	surface area
$V$	volume of solids
$w$	width

## Decimal system prefixes

Prefix	Symbol	Value	Value in words	Example	Meaning
pico	p	$10^{-12}$	one trillionth of	1 pF	picofarad
nano	n	$10^{-9}$	one thousand millionth of	1 ns	nanosecond
micro	$\mu$	$10^{-6}$	one millionth of	1 $\mu$ s	microsecond
milli	m	$10^{-3}$	one thousandth of	1 mg	milligram
centi	c	$10^{-2}$	one hundredth of	1 cm	centimetre
deci	d	$10^{-1}$	one tenth of	1 dB	decibel
unit					
deca	da	$10^1$	10 times	not commonly used in Australia	
hecto	h	$10^2$	100 times	1 hL	hectolitre
kilo	k	$10^3$	1000 times	1 kg	kilogram
mega	M	$10^6$	1 million times	1 ML	megalitre
giga	G	$10^9$	1 thousand million times	1 GB	gigabyte

## Numerical prefixes

Prefix	Meaning	Example
mono	1	monorail
bi	2	bicycle, binary
tri	3	tricycle, triangle
tetra	4	tetrahedron, tetrapack
quad	4	quadrilateral, quads
penta, quin	5	pentagon
hexa	6	hexagon
hepta, septi	7	heptagon
octa	8	octagon
nona, non	9	nonagon
deca	10	decagon, decahedron
undeca	11	undecagon
dodeca	12	dodecagon, dodecahedron
icosa	20	icosahedron
hect	100	hectare
kilo	1000	kilogram
mega	1 000 000	megalitre, megawatt
giga	1000 million	gigabyte

## Other prefixes

Prefix	Meaning	Example
anti	opposite, against	anti clockwise
circum	around	circumference
co	together	cointerior, coordinate
geo	earth	geometry
hemi	half	hemisphere
macro	very big	macrocosmos
micro	very small	microbe
multi	many, much	multibase blocks
peri	around	perimeter
poly	many	polygon
semi	half	semicircle
sub	below, under	subset
trans	across, beyond, over	transversal
uni	one, having one	unit

## The multiplication square

×	1	2	3	4	5	6	7	8	9	10
1	1	2	3	4	5	6	7	8	9	10
2	2	4	6	8	10	12	14	16	18	20
3	3	6	9	12	15	18	21	24	27	30
4	4	8	12	16	20	24	28	32	36	40
5	5	10	15	20	25	30	35	40	45	50
6	6	12	18	24	30	36	42	48	54	60
7	7	14	21	28	35	42	49	56	63	70
8	8	16	24	32	40	48	56	64	72	80
9	9	18	27	36	45	54	63	72	81	90
10	10	20	30	40	50	60	70	80	90	100



## Greek alphabet

The letters of the Greek alphabet are used as symbols for angles, mathematical operations, etc.

### Examples

$\alpha, \beta, \gamma, \delta, \dots \pi \dots$

$\Sigma$  sum

$\infty$  infinity

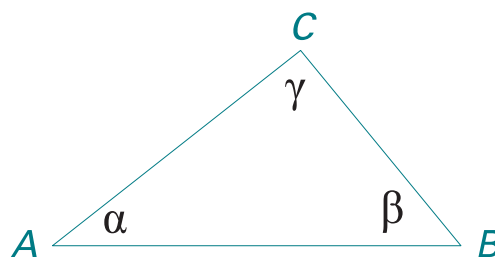

Capital	Lower case	Handwritten	Pronunciation
A	$\alpha$	$\alpha$	alpha
B	$\beta$	$\beta$	beta
Γ	$\gamma$	$\gamma$	gamma
Δ	$\delta$	$\delta$	delta
E	$\epsilon$	$\epsilon$	epsilon
Z	$\zeta$	$\zeta$	zeta
H	$\eta$	$\eta$	eta
Θ	$\theta$	$\theta$	theta
I	$\iota$	$\iota$	iota
K	$\kappa$	$\kappa$	kappa
Λ	$\lambda$	$\lambda$	lambda
M	$\mu$	$\mu$	mu
N	$\nu$	$\nu$	nu
Ξ	$\xi$	$\xi$	xi
O	$\omicron$	$\omicron$	omicron
Π	$\pi$	$\pi$	pi
P	$\rho$	$\rho$	rho
Σ	$\sigma$	$\sigma$	sigma
T	$\tau$	$\tau$	tau
Υ	$\upsilon$	$\upsilon$	upsilon
Φ	$\phi$	$\phi$	phi
X	$\chi$	$\chi$	chi
Ψ	$\psi$	$\psi$	psi
Ω	$\omega$	$\omega$	omega

## Conversion tables: metric and imperial

### length

Metric		Imperial
1 mm		0.03937 in
1 cm	10 mm	0.3937 in
1 m	100 cm	1.0936 yd
1 km	1000 m	0.6214 mile

Imperial		Metric
1 in		2.54 cm
1 ft	12 in	0.3048 m
1 yd	3 ft	0.9144 m
1 mile	1760 yd	1.6093 km
1 nautical mile	2025.4 yd	1.853 km

### area

Metric		Imperial
1 cm <sup>2</sup>	100 mm <sup>2</sup>	0.155 in <sup>2</sup>
1 m <sup>2</sup>	10 000 cm <sup>2</sup>	1.1960 yd <sup>2</sup>
1 ha	10 000 m <sup>2</sup>	2.4711 acres
1 km <sup>2</sup>	100 ha	0.3861 mile <sup>2</sup>

Imperial		Metric
1 in <sup>2</sup>		6.4516 cm <sup>2</sup>
1 ft <sup>2</sup>	144 in <sup>2</sup>	0.0929 m <sup>2</sup>
1 yd <sup>2</sup>	9 ft <sup>2</sup>	0.8361 m <sup>2</sup>
1 acre	4840 yd <sup>2</sup>	4046.9 m <sup>2</sup>
1 mile <sup>2</sup>	640 acres	2.59 km <sup>2</sup>

**mass**

Metric		Imperial
1 mg		0.0154 grain
1 g	1000 mg	0.0353 oz
1 kg	1000 g	2.2046 lb
1 t	1000 kg	0.9842 ton

Imperial		Metric
1 oz	437.5 grain	28.35 g
1 lb	16 oz	0.4536 kg
1 stone	14 lb	6.3503 kg
1 hundredweight (cwt)	112 lb	50.802 kg
1 long ton	20 cwt	1.016 t

**volume**

Metric		Imperial
1 cm <sup>3</sup>		0.0610 in <sup>3</sup>
1 dm <sup>3</sup> (decimetre)	1000 cm <sup>3</sup>	0.0353 ft <sup>3</sup>
1 m <sup>3</sup>	1000 dm <sup>3</sup>	1.3080 yd <sup>3</sup>
1 L	1 dm <sup>3</sup>	1.76 pt (pint)
1 hL (hectolitre)	100 L	21.997 gal

Imperial		Metric
1 in <sup>3</sup>		16.387 cm <sup>3</sup>
1 ft <sup>3</sup>	1728 in <sup>3</sup>	0.0283 m <sup>3</sup>
1 fl oz (fluid ounce)		28.413 mL
1 pt	20 fl oz	0.5683L
1 gal	8 pt	4.5461L

**temperature**

to convert from Celsius  
to Fahrenheit:

$$F = \frac{9}{5} \times \text{Celsius} + 32$$

To convert from Fahrenheit  
to Celsius:

$$C = \frac{5 (\text{Fahrenheit} - 32)}{9}$$

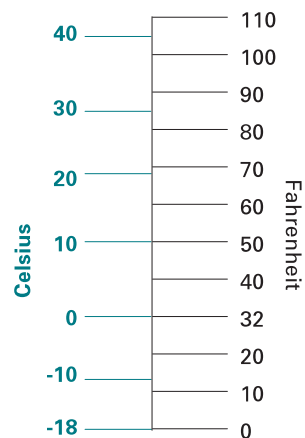

## Computing terms

### bit

The smallest representation of computer storage. A bit can be either a 0 (off) or 1 (on). A bit represents the electrical state of a circuit on a motherboard (i.e. on or off).

*See byte*

### Boolean function

Mathematical logic used for searching computer databases. Common Boolean functions include AND, OR and NOT.

#### *Example*

Database Search: first name = 'John' AND age = '20'

This will only return all people with the first name of John who are aged 20.

Database Search: first name = 'John' OR age = '20'

This will return all people with the first name of John and all people who are aged 20.

Database Search: first name = 'John' NOT age = '20'

This will return all people with the first name of John who are not 20 years old.

### byte

A measurement of computer-based storage and also representation of computer data.

1 byte = 8 bits

#### *Example*

10011101 = 1 byte (computer-based storage)

10011101 = 157 (computer data)

*See bit, kilobyte*

### CPU

#### (Central Processing Unit)

The central part of the computer which controls all of the processing of data. It is situated on the motherboard of a computer system and its speed is measured in hertz.

*See hertz, kilohertz, megahertz, gigahertz*

### flowchart

A method of describing an algorithm using symbols.

Symbols used:

Terminal – to begin and end the flowchart

Process – an action or step

Decision – alternate options or pathways

Flowline – used to connect symbols together and to describe the path of the algorithm

*See algorithm*

### gigabyte (Gb)

A measurement of computer-based storage.

1 gigabyte = 1024 megabytes

*See bit, byte, kilobyte, megabyte, terabyte*

### gigahertz (GHz)

One billion cycles or electrical pulses per second of a computer CPU.

1 GHz = 1000 MHz = 1 000 000

Kz = 1 000 000 000 Hz

*See CPU, hertz, kilohertz, megahertz*

---

## hertz

(Hz)

A measurement of clock speed of a computer CPU. It is also used to measure sound frequencies for hearing aids and radio transmission.

1 hertz = 1 cycle or electrical pulse of a CPU per second

*See CPU, megahertz, gigahertz*

---

## hexadecimal

Containing 16 parts or digits. It is a base 16 number system that is made up of 16 digits. The digits represented by this number system are 0 to 9 and then A to F. This number system is used primarily by computer systems, particularly by the programming languages that control computer hardware. It is also the number system used to represent colours on web pages.

### *Example*

Digits represented:

0, 1, 2, 3, 4, 5, 6, 7, 8, 9

A = 10

B = 11

C = 12

D = 13

E = 14

F = 15

*See binary, decimal, octal*

---

## kilobyte

(Kb)

A measurement of computer-based storage.

1 kilobyte = 1024 bytes

*See bit, byte, megabyte*

---

## kilohertz

(KHz)

One thousand cycles or electrical pulses per second of a computer CPU.

1 KHz = 1000 Hz

*See CPU, hertz, gigahertz*

---

## megabyte

(Mb)

A measurement of computer-based storage.

1 megabyte = 1024 kilobytes

*See bit, byte, kilobyte, gigabyte*

---

## megahertz

(MHz)

One million cycles or electrical pulses per second of a computer CPU.

1 MHz = 1000 KHz = 1 000 000 Hz

*See CPU, hertz, kilohertz*

---

## octal

Containing 8 parts or digits. It is a base 8 number system that is made up of 8 digits. The digits represented by this number system are 0 to 7. This number system is used primarily by computer systems, particularly by certain programming languages.

### *Example*

Digits represented: 0, 1, 2, 3, 4, 5, 6, 7

*See binary, decimal, hexadecimal*

---

## RAM

### (Random Access Memory)

The primary memory of a computer system. When a computer system is turned off, all contents in RAM are lost. The capacity of RAM is measured in bytes.

*See* byte, kilobyte, megabyte, gigabyte, terabyte

---

## resolution

A measurement of the quality of a digital image. It is calculated by multiplying the number of dots (pixels) horizontally of the image by the number of dots (pixels) vertically of the image.

### *Example*

Resolution of an image with 1024 horizontal pixels by 768 vertical pixels:

Resolution =  $1024 \times 768 = 786\,432$  pixels

1 000 000 pixels = 1 megapixel

---

## terabyte

### (Tb)

A measurement of computer-based storage.

1 terabyte = 1024 gigabytes

*See* bit, byte, kilobyte, megabyte, gigabyte

